

CTD CONSOLIDATED Toledo Drill

America's Finest High-Speed Steel Cutting Tools™



Proudly Manufactured in the USA

Table of Contents

Twist Drills

Jobber Length NAS 907B Heavy Duty 135° Split point

Type 190-AG Heavy Duty Magnum	6
Type 190-CN CN-TECH™ CRYO/NITRIDE	7
Type 170-AG	8 - 9
*Type 128-AG 3/8" Shank	7
Type 190 Black Oxide	10 - 11
*Type 198 V-Line Black Oxide.	15
Type 190-AN Titanium Nitride	10 - 11
Type 190-ACN Titanium Carbon Nitride	12 - 14
Type 190-ALN Aluminum Titanium Nitride	12 - 14
*Type 190-GF Gold Strike™ 3-flats on Shank	15
*Type 190-GFR Gold Strike™ 3/8" Shank	15

Mechanic Length 135° Split point

Type 175-AG	28
Type 178-AG Magnum 3/8" Shank	28
Type QR-AG Magnum 1/4" Hex Shank	29
Type QR-AG Extensions 3", 6", 12"	29
Type 191 V-line Black Oxide	28

Jobber Length NAS 907A

Type 340-A Black Oxide 118° Split point	16
---	----

Jobber Length General Purpose 118° point

Type 100 Bright Finish	17 - 21
Type 115 Black Oxide	17 - 21
Type 170-W Metric - Bright Finish	22
Type 128 3/8" Reduced - Bright Finish	23
Type 100-BN Titanium Nitride Coated.	17 - 21
Type 170 Metric - Black Oxide	22
Type 118 V-Line Black Oxide	21
Type 230 Tang Drive.	27

Taps & Dies

HSS Spiral Point Taps

Type 20-AG Plug - Fractional / Machine Screw.	55
Type 20 Plug - Fractional / Machine Screw.	55
Type 21-AG Plug - Metric	55
Type 21 Plug - Metric	55

HSS Straight Flute Taps

Type 23-AG Taper.	58-60
Type 23-AGN Taper - Titanium Nitride	58-60
Type 23 Taper.	58-60
Type 24-AG Plug	58-60
Type 24-AGN Plug - Titanium Nitride.	58-60
Type 24 Plug.	58-60
Type 25-AG Bottoming.	58-60
Type 25-AGN Bottoming - Titanium Nitride	58-60
Type 25 Bottoming	58-60
Type 26-AG Sets	61
Type 26-AGN Sets Titanium Nitride	61
Type 26 Sets	61

HSS Straight Flute - Metric

Type 31-AG Taper.	62
Type 31-AGN Taper - Titanium Nitride	62
Type 31 Taper	62
Type 32-AG Plug	62
Type 32-AGN Plug - Titanium Nitride.	62
Type 32 Plug	62
Type 33-AG Bottoming	62
Type 33-AGN Bottoming - Titanium Nitride.	62
Type 33 Bottoming	62
Type 35-AG Sets	63
Type 35-AGN Sets Titanium Nitride	63
Type 35 Bottoming	63

HSS Straight Flute - Left-Hand Thread

Type 23L-AG Taper	64
Type 24L-AG Plug	64
Type 25L-AG Bottoming	64

HSS Spiral Flute Semi-Bottoming Taps

FRACTIONAL	
Type 36-ACN, 36-AGN, 36 30° Spiral TICN, TIN	65
Type 37-ACN, 37-AGN, 37 52° Spiral TICN, TIN	65 - 66

Jobber Length Parabolic 135° Split point

Type 190-P Black Oxide	25 - 26
Type 190-PT Titanium Nitride Coated	25 - 26

Jobber Length Hi-Helix 135° SP

Type 190-SS Black & Gold	9
------------------------------------	---

Jobber Length Hi-Helix 118° point

Type 240-F Bright Finish	24
------------------------------------	----

Screw Machine Length NAS 907C

Type 135-AG	34 - 35
Type 135 Black Oxide	37
Type 135-TN Titanium Nitride Coated	37
Type 260-TW Bright Finish	37
*Type 125 1/4" Reduced Shank.	36

Screw Machine Length 118° point

Type 260 Bright Finish	38 - 39
Type 260-BN Titanium Nitride Coated.	38 - 39

1/4" Shank 118° Point

Type 120	23
--------------------	----

Drill Blank

Type 240-DB Fully Hardened - Precision Ground	50
---	----

Jobber Length Cobalt NAS 907J

Type 150 M42 135° Split point	30
Type 150-N M42 Titanium Nitride	30
Type 150-ALN M42 Titanium Aluminum Nitride	30
Type 150-M M42 Metric - 135° Split point	31

DIN Length Wide Land Parabolic Cobalt

Type XGT-J M42 135° Split point	32 - 33
Type XGT-JN M42 135° SP TIN Coated	33

Screw Machine Length Cobalt

Type 260-D M42 135° Split point	35-36
Type 260-DN M42 Titanium Nitride Coated	35
Type 260-AND M42 Titanium Aluminum Nitride	35

Metric	
Type 38-ACN, 38-AGN, 38 30° Spiral TICN, TIN	66
Type 39-ACN, 39-AGN, 39 52° Spiral TICN, TIN	66

HSS Combination Drill & Tap

Type 40-AG	67
Type 40-QR.	67

Drill & Tap Combo

Type 34-AG	67
----------------------	----

HSS Hex Dies

Type 27-AG	66
Type 27-AG Metric	66

Extension Spiral Point Plug Taps

Type 20-EXT	56
-----------------------	----

High Performance Spiral Tap

Type 29-AG	56
Type 29-AGN Titanium Nitride	56
Type 29-ACN	57
Type 29-ALN	57

M42 Cobalt Taps

Type 24-RNC	58
Type 24-RNCN	58

HSS Extension Taper Pipe Taps

Type 30-EXT	63
-----------------------	----

Taper Pipe Taps Regular / Interrupted

Type 30-AG, I30-AG.	63
Type 30-AGN, I30-AGN	63
Type 30-B, I30-B	63
Type 30, I30	63
12pc Taps & Dies For Pipe	63

HSS Tap & Drill Sets

SF-18TDC Straight Flute	67
SF-18TDF Straight Flute	67
SP-10TD Spiral Point	67
SP-12TD Spiral Point	67
SP-18TD Spiral Point	67
SP-18TDM Spiral Point	67
B-18TD HSS Drill & Tap Set	67

HSS Tap Sets

SP-19T Spiral Point.	68
SP-10T Spiral Point.	68
SF-10T Straight Flute	68

Silver & Deming 1/2" Shank

Type 130-AG Magnum 135° Split point	45
Type 130-AGX 118° Split point 3 - Flats	45
Type 130-CN CN-TECH™ CRYO/NITRIDE.	45
Type 130-AGM Metric - 135° Split point	46
Type 130-MRO Mechanic Length 135° Split Pt.	47
Type 130 118° point - Round Shank	46
Type 130-VT VORTEX-POINT	46
Type 130-D M42 135° Split point	47
Type EXT Extension OAL 7-1/2"	47

Silver & Deming 3/4" Shank

Type 131-AG 135° Split point - Round Shank	46
--	----

Taper Length

Type 210 118° pt. - General Purpose	40 - 41
Type 220 118° point - Tang Drive	41
Type 221-P Parabolic - Tang Drive	42
Type 221-PT Titanium Nitride Coated 135° SP	42

Extra Length

Type XGT-AG 6" 9" 12"	43
Type 160 12" - OAL 9" Flute	43
Type 165 18" - OAL 12" Flute	43

Aircraft Extension

Type 166 6" - OAL Black Oxide	44
Type 167-D 6" - OAL Cobalt NAS 907J	44
Type 168 12" - OAL Black Oxide NAS 907B.	44
Type 169-D 12" - OAL Cobalt NAS 907J	44

Taper Shank

Type 510 Regular Shanks.	48 - 49
Type 520 Larger than Standard.	49
Type 500 Smaller than Standard.	49

Technical Reference 51 - 53

Drill, Tap & Countersink Set

TDC-12	68
------------------	----

HSS Tap & Die Assortments

Magnum Super Premium	
14pc. 24pc. Metric.	69
15pc. 25pc.	69
40pc. 58pc.	70

Hi-Carbon Steel Taps

Type 720 Plug - Fractional	71
Type 721 Plug - Machine Screw	71
Type 740 Taper - Fractional.	71
Type 741 Plug - Machine Screw	71
Type 760 Bottoming - Fractional	72
Type 761 Bottoming - Machine Screw.	72
Type 722 3pc. - Fractional Set.	72
Type 723 3pc. - Machine Screw.	72
Type 780 Metric Plug Taps	75

Hi-Carbon Steel Pipe Taps

Type 410 Fractional	75
-------------------------------	----

Hi-Carbon Steel Dies

Type 400 - Round.	74
Type 405 - Hex	73
Type 415 - Adjustable	74
Type 790 - Metric - Hex.	73

Hi-Carbon Tap & Die Sets

Type 724	
14pc. 16pc.	76
24pc. 37pc.	77
40pc.	78

Tap & Reamer Wrenches / Die Stocks

Type 725	79
Type 726	79
Type 727	79
Type 727-R Ratcheting T-Handle	79
Type 728	80
Type 728R Round Die Stock	80
Type 729	80
Type 730 Screw Pitch Gauges	80

Technical Reference 81 - 85

Table of Contents

Premium Carbide Burrs

SA Style			
Cylinder Shape - No End Cut	87	SH Style	
SB Style		Flame Shape	90
Cylinder Shape - with End Cut	87	SJ Style	
SC Style		60° Cone Shape	90
Cylinder Shape - Radius End	88	SK Style	
SD Style		90° Cone Shape	90
Ball Shape	88	SL Style	
SE Style		Taper Shape Radius -14° Included Angle	90
Oval / Egg Shape	89	SM Style	
SF Style		Pointed Cone Shape	91
Tree Shape Radius	89	SN Style	
SG Style		Inverted Cone Shape	91
Pointed Tree Shape	90		

Premium Carbide Burrs Sets

Double Cut Sets	
Set A - 9 pc	91
Set B - 9 pc	91
Set C - 9 pc	91
Set D - 9 pc	91
Set E - 8 pc	91
Set F - 8 pc	91
Double Cut Display	48pc.
Double Cut - 1/8" Shank	91
Double Cut - 1/4" Shank	91
Aluma Cut - 1/4" Shank	91
	24pc.
Double Cut- 1/4 Shank	91

Magnetic Base Drills & Annular Cutters

Annular Cutters		Counter Display High-Speed Steel		Spira-Broach™ Magnetic Base Drills	
Type14 & 14L M35 Cobalt	94	Annular Sets	95	MBD 40 Variable Speed Motor - Duty .	93
Type15C & 15CL Carbide Tipped	94	Counter Displays	95	MBD 6500 Heavy - Duty	93
Type13SP&13LSP M2 HSS.	94			MBD 7000 Heavy Duty - Reverse . . .	93

Specialty Tools

Acrylic Drills		Cutting Tool Lubricant		Left-Hand Screw Machine	
Type 183-AG	106	Type 11-AG	106	Type 135-AL	97
Auger Bits		Drywall Bits For Cutouts		All Purpose Heavy Duty	
Type 950, 951 952 & 953	102	Type 180-GP Black & Gold	102	Type 214 Carbide Tipped	105
Bolt Remover		Type 180-SA Bright Finish	102	Pilot Drills	
Bolt Extractors Set	99	Glass & Tile Drills		Type 185	105
Type 420 Spiral	98	Type 626	99	Step Drill Bits	
Type 421-AG Square	98	Hard Steel Drills		Type 175-VT VORTEX ^{POINT} 	103
Brad Point Drills		Type 602 Carbide Tipped	106	Power Bits	
Type 16-AG	103	Type 602-C Solid Carbide	106	Type 935	103
Type 16-AG Sets	103	Reamers		Type 935 Sets	103
Carbide Tipped Hole cutters		Type 50-AG Standard Flute - Car Reamers . .	100	Type QR-AG Extensions 3", 6", 12" . .	103
Type CHC-AG	107	Type 51-AG Fast Spiral - Car Reamers . . .	100	Sheeters Drills	
Type CHD-AG	107	Type 51-AGM Fast Spiral Mechanics Length 	100	Type 224	106
Type CHC-QR	107	Type 52-AG Hex Nut Bridge Length	100	Step Drills - Multi-Diameter	
Type HC-3QR	107	Type 53-AG Hex Nut Car Length	100	Type B78-AG	104
Type Ext OAL- 6-1/4"	107	Type 54-AG Straight Flute -Taper Shank . .	101	Type B78-AGN	104
Hanging Display of CHC-QR	107	Type 55-AG Spiral Flute -Taper Shank . . .	101	Type B78-ACN	104
Counter sinks		Hole Hog™ & Sets		Type 78-QR	104
Type 82-AG Piloted	108	Type 134-AG Hole Hog™ & Sets 	102	Type 78-QRN	104
Type 82-AG Pilotless	108	Step Reamers & Sets		Twin End Drills	
Type 90-AG Deburring	108	Type 78-GR Gold Oxide	101	Type 140-G	105
Technical Diagram	108	Type 78-ZR Zirconium Nitride	101	Type 140	105
Type 83-AG 6-Flute	109	Left-Hand Spiral Drills		Weldout™ Spot weld Drills & Sets	
Combined Drills & Counter sinks		Type 420-AL Carded	97	Type 186 Weldout™ Spot weld	110
Type 296	109	Type 190-AL	97	Type 187 Weldout™ Spot weld	110
Type 296-XL	109	Type 190-AL Sets	97	Type 187-DN Titanium Nitride	110
Combined Drill & Countersinks Set	109	Left-Hand VORTEX^{POINT} & Spiral Extractor		Type 187-B Carbide ALTiN Coated	110
		Type 175-VTL 	97	Type 187 WO-4 Set	110
				Type 186 WO-6 Set	110

Table of Contents

Cutting Tool Sets

Jobber Length NAS 907B	
Heavy Duty 135° Split point	
Type 190-CN	CN-TECH™ CRYO/NITRIDE... 112
Type 190-AG	Heavy Duty Magnum... 112
Type 170-AG	Metric... 112
*Type 128-AG	3/8" Shank... 112
Type 190	Black Oxide... 114 - 115
*Type 198	V-Line Black Oxide... 116
Type 190-AN	Titanium Nitride... 114 - 115
Type 190-ACN	Titanium Carbon Nitride... 114 - 115
Type 190-ALN	Aluminum Titanium Nitride... 114 - 115
*Type 190-GF	Gold Strike™ 3-Flats... 116
*Type 190-GFR	Gold Strike™ 3/8" Reduced... 116
* Not NAS907B	
Mechanic Length 135° Split point	
Type 175-AG	... 113
Type 178-AG	Magnum 3/8" Shank... 113
Type QR-AG	1/4" Hex Shank... 113
Type 191	V-line Black Oxide CAD-HD... 124
Mechanic Length 135° SP	
Type 175-VT	VORTEX-POINT... 113
Type VT&R-8P	VORTEX-POINT & Fast Spiral Reamers... 126
Jobber Length Hi-Helix 135° SP	
Type 190-SS	Black & Gold... 114
Jobber Length General Purpose 118° point	
Type 100	Bright Finish... 119 - 121
Type 128	3/8" RS Bright Finish... 119 - 121
Type 100-BN	Titanium Nitride... 119 - 121
Type 115	Black Oxide... 119 - 121
Type 170	Metric - Black Oxide... 121
Type 118	V-Line Black Oxide... 119 - 120
Jobber Length Parabolic 135° Split point	
Type 190-P	Black Oxide... 123
Type 190-PT	Titanium Nitride... 123
Screw Machine Length NAS 907C	
Type 135-AG	... 122
Type 135	Black Oxide... 125
Type 135-TN	Titanium Nitride... 125
* Not NAS907C	

Screw Machine Length 118° point	
Type 260	Bright Finish... 124
Type 260-BN	Titanium Nitride... 124
1/4" Shank 118°	
Type 120	... 122
Jobber Length Cobalt NAS 907J	
Type 150	135° Split point... 117
Type 150-N	Titanium Nitride... 117
Type 150-M	Metric - 135° SP... 117 - 118
Screw Machine Length M42 Cobalt	
Type 260-D	135° Split point... 122
Silver & Deming 1/2" Shank	
Type 130-AG	135° Split point... 126
Type 130-AGX	118° Split pt 3-flats... 126
Type 130-CN	CN-TECH™ CRYO/NITRIDE... 126
Type 130-D	135° Split Point... 126
Type 130	118° point - Round Shank... 126
Type 130-MRO	135° Split Point... 126
Step Drills	
Type 78-AG	... 129
Type 78-AGN	Titanium Nitride... 129
Type 78-ACN	... 129
Type 78-QR	... 129
Type 78-QRN	Titanium Nitride... 129
Acrylic Drills	
Type 183-AG	Super Chipfree™ pt... 124
Combination Drill & Tap	
Type 40-AG	... 128
Type 40-QR	... 128
Weldout™ Spot weld Drills	
Type 187	WO-4... 127
Type 186	WO-6... 127
Left Hand Spiral	
Type 190-AL	... 127

Brad Point Drills	
Type 16-AG	... 127
Tap & Drill Sets	
B-18TD	... 128
SP-18TD	... 128
SP-18TDM	... 128
SP-18TDF	... 128
SP-12TD	... 128
SF-18TDC	... 128
SF18TDF	... 128
SF-10TD	... 128
Bolt Extractor	
BR-8	Left Hand Drill Bolt Extractor... 129
BR-10	Left Hand Drill Bolt Extractor... 129
SE-4N	Bolt Extractor-Spiral Extractor... 129
SE-5N	Bolt Extractor-Spiral Extractor... 129
BR-8SQ	Left Hand - Bolt Extractor... 129
SQE-4	Bolt Extractor-Spiral Extractor... 129
Chatterproof™ Counter sink	
Type 82-AG	Counter sink... 129
Type 90-AG	Deburring Tools... 129
Hole Expansion Tools	
Type 50-AG	Standard Flute... 130
Type 51-AG	Fast Spiral... 130
Hole Hog™	
Type 134-AG	... 130
Carbide Hole Cutters	
Type CHC-AG & CHD-AG	... 130
3pc. Carbide Hole cutter CHC-AG	... 130
3pc. Quick Release Set	... 130

Displays, Cabinets & Indexes

Counter Displays	
Silver & Deming	... 133
Reamers	... 133
Type 50-AG & Type 51-AG	... 134
Annular Cutter	... 134
Annular Cutter Sets	
... 134	
Stock Master Dispensers & Displays	
Type 925	300pc. Fractional... 132
Display Packages	
Type 175-AG	... 142
Type CHC-AG	... 142
Drill Gauges	
Type 914	Letter, Fractional & Wire... 139
Drill Stand	
Type 914	Letter, Fractional & Wire... 139

Indexes	
Type 902	Indexes Only... 143
Type 902	Black Indexes - ID Plate Slot... 144
Master Drill Dispensers	
Type 914	U.S. & Metric Sizes... 137
Master Tap Dispensers	
Type 914	... 138
Silver & Deming Drill Dispensers	
Type 914	... 136
Stocking Cases	
Type 925	13pc. Silver & Deming... 135
	72pc. Letter... 135
	91pc. Metric... 135
	96pc. Fractional... 135
	249pc. Wire... 135

Carbide Holecutter Display	
Type CHC-AG	... 142
Tap & Die Counter tops	
Tap & Round Die	... 140
Tap & Hex Die	... 140
Magnum Super Premium	
53-SF	Straight Flute... 140
55-SP	Spiral Point... 140
Drawer-Mount Dispensers	
Type 914	Fractional, Wire, Letter & Empty... 140
Tap & Drill Assortments Super Premium	
67-SP	Spiral Point... 141
123-SP	Spiral Point... 141
123-SF	Straight Flute... 141

Technical Reference

Drill Bits	
Decimal Equivalent	
& Tap Drill Sizes Chart	... 51
Drill Feeds & Speeds	... 52
Twist Drill Trouble Shooting	... 53

Taps & Dies	
Standard Cutting Taps	... 81
Metric Cutting Taps	... 82
Tap Trouble Shooting	... 83

Tap Limits, Product Limits	... 84
Tread Constants for	
Various Percentages	... 85

WHY CHOOSE MAGNUM?

- ✓ **Substantially longer cutting life**
The nitro-carburized flute has an increased Rockwell hardness.
- ✓ **Cuts harder materials**
The flatter point takes a smaller chip. More torque is directed to a smaller area. This allows drilling into materials with hardness of over 30 on the Rockwell "C" scale.
- ✓ **Stops drill walking**
The split point design gives accurate starting without the use of a center punch.
- ✓ **Holds tighter hole size**
The split point design is self centering. This limits the normal oversize drilling characteristics.
- ✓ **Outstanding quality appearance**
The rich amber gold color sets it apart from commodity cutting tools.
- ✓ **Runs cooler, uses less torque**
135° point takes a smaller chip resulting in less heat. Friction is reduced by amber gold surface treatment.
- ✓ **Stops chuck slippage**
Flats on drill shanks allow easy positive chuck grip.

MAGNUM SUPER PREMIUM vs. COBALT

The Magnum Super Premium drills will substantially outperform cobalt drills in work hardening stainless steel applications. This performance advantage is the result of construction differences between the two types of drills. Cobalt drills, manufactured to **Type J NAS 907** specs, have a very thick web. This web is necessary to limit breakage of the brittle cobalt steel. Magnum Super Premium drills are made of special hi-moly tool steel, which is much tougher than cobalt steel. The web on an Magnum Super Premium drill can be thinned considerably due to the toughness of the steel.

An Magnum Super Premium drill with its thin web will penetrate the work hardening stainless fast enough to continually cut beneath the chip which is hardening from deformation. This means the drill is cutting softer steel. The cobalt drill, with its thick web, cannot be fed at a fast enough rate to cut beneath the area which is hardening. As a result the cobalt drill is continually drilling into hardened steel.

STAINLESS STEEL WORK HARDENING VS. FREE MACHINING

Work hardening grades of stainless are the 300 series with the exception of 303, which is free machining. Free machining grades include the 400 series in addition to type 303. A quick way to identify work hardening vs free machining stainless is to observe the chip formation. Work hardening chips break up during the drilling process, while free machining chips are long and stringy.

COBALT APPLICATIONS

Cobalt drills are recommended for free machining stainless (400 series & 303), titanium alloys and other high tensile strength materials. These applications require the high red hardness of cobalt steel to counter the substantial heat generated in the drilling process.

NORSEMAN MAGNUM SUPER PREMIUM™ VS. COBALT

Magnum Super Premium drill with its thin web will penetrate the work hardening stainless fast enough to continually cut beneath the chip which is hardening from deformation. This means the drill is cutting softer steel.

The cobalt drill, with its thick web, cannot be fed at a fast enough rate to cut beneath the area which is hardening. As a result the cobalt drill is continually drilling into hardened steel.

**MAGNUM
SUPER PREMIUM**

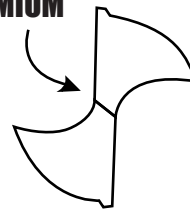

WEB COBALT

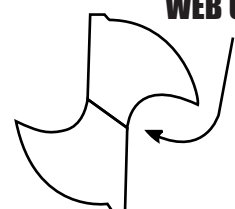

Twist Drill Index

Jobber Length

NAS 907B Heavy Duty 135° Split Pt

Type 190-AG Heavy Duty Magnum 6

Type 190-CN CN-TECH™ Cryo Nitride 7

Type 170-AG 8 - 9

*Type 128-AG 3/8" Shank 7

Type 190 Black Oxide 10 - 11

*Type 198 V-Line Black Oxide. 15

Type 190-AN Titanium Nitride 10 - 11

Type 190-ACN Titanium Carbon Nitride 12 - 14

Type 190-ALN Aluminum Titanium Nitride 12 - 14

*Type 190-GF Gold Strike™ 3-flats on Shank 15

*Type 190-GFR Gold Strike™ 3/8" Shank . . . 15

* Not NAS907B

Mechanic Length 135° Split point

Type 175-AG 28

Type 178-AG Magnum 3/8" Shank 28

Type QR-AG Magnum 1/4" Hex Shank. . . . 29

Type QR-AG Extensions 3",6",12" . . . 29

Type 191-A V-line Black Oxide 28

Jobber Length NAS 907A

Type 340-A Black Oxide 118° Split point . . . 16

Jobber Length

General Purpose 118° point

Type 100 Bright Finish 17 - 21

Type 115 Black Oxide. 17 - 21

Type 170-W Metric - Bright Finish 22

Type 128 3/8" Reduced - Bright Finish 23

Type 100-BN Titanium Nitride Coated . . . 17 - 21

Type 170 Metric - Black Oxide. 22

Type 118 V-Line Black Oxide 21

Type 230 Tang Drive. 27

Jobber Length Parabolic 135° Split Pt

Type 190-P Black Oxide 25 - 26

Type 190-PT Titanium Nitride Coated . . . 25 - 26

Jobber Length Hi-Helix 135° SP

Type 190-SS Black & Gold 9

Jobber Length Hi-Helix 118° point

Type 240-F Bright Finish 24

Screw Machine Length NAS 907C

Type 135-AG 34 - 35

Type 135 Black Oxide 37

Type 135-TN Titanium Nitride Coated 37

Type 260-TW Bright Finish 37

*Type 125 1/4" Reduced Shank. 36

* Not NAS907B

Screw Machine Length 118° point

Type 260 Bright Finish 38 - 39

Type 260-BN Titanium Nitride Coated. 38 - 39

1/4" Shank 118° Point

Type 120 23

Drill Blank

Type 240-DB 50

Jobber Length Cobalt NAS 907J

Type 150 M42 135° Split point 30

Type 150-DN M42 Titanium Nitride Coated 30

Type 150-ALN M42 Titanium Aluminum Nitride 30

Type 150-M M42 Metric - 135° Split point 31

DIN Length Wide Land Parabolic Cobalt

Type XGT-J M42 135° Split point . . . 32 - 33

Type XGT-JN M42 135° SP Titanium Nitride 33

Screw Machine Length Cobalt

Type 260-D M42 135° Split point. . . . 35-36

Type 260-DN M42 Titanium Nitride. 35

Type 260-AND M42 Titanium Aluminum Nitride 35

Silver & Deming 1/2" Shank

Type 130-AG Magnum 135° Split point 45

Type 130-AGX 118° Split point 3 - Flats . 45

Type 130-CN CN-TECH™ CRYO/NITRIDE 45

Type 130-AGM Metric - 135° Split point 46

Type 130-MRO 1/2" Reduced Shank . . . 47

Type 130 118° point - Round Shank . . . 46

Type 130-VT VORTEX-POINT 46

Type 130-D M42 135° Split point. 47

Type EXT Extension OAL 7-1/2" 47

Silver & Deming 3/4" Shank

Type 131-AG 46

Taper Length

Type 210 118° pt. - General Purpose. 40 - 41

Type 220 118° point - Tang Drive 41

Type 221-P Parabolic - Tang Drive 42

Type 221-PT Titanium Nitride Coated 135° SP 42

Extra Length

Type XGT-AG 6" 9" 12". 43

Type 160 12" - OAL 9" Flute 43

Type 165 18" - OAL 12" Flute 43

Aircraft Extension

Type 166 6" - OAL Black Oxide 44

Type 167-D 6" - OAL Cobalt NAS 907J . . . 44

Type 168 12" - OAL Black Oxide NAS 907B44

Type 169-D 12" - OAL Cobalt NAS 907J . . . 44

Taper Shank

Type 510 Regular Shanks 48 - 49

Type 520 Larger than Standard. 49

Type 500 Smaller than Standard 49

Technical Reference. . . 51 - 53



QUICK INDEX - Twist Drills

Jobber Length

HEAVY-DUTY SUPER PREMIUM NAS 907B

Type 190-AG

NAS 907B Super Premium - 135° Split Point

- Nitro-Carburized
- Magnum will substantially outperform cobalt drills in work hardening stainless steel and other tough drilling applications.



Type 190-AG

Low temperature stress relief improves lubricity and toughness.

Part #	Diameter Inches	Overall Length Inches	Flute Length Inches	Qty. per/pack
05580	1/16	1-7/8	7/8	12
05590	5/64	2"	1	12
05600	3/32	2-1/4	1-1/4	12
05610	7/64	2-5/8	1-1/2	12
05620	1/8	2-3/4	1-5/8	12
05630	9/64	2-7/8	1-3/4	12
05640	5/32	3-1/8	2	12
05650	11/64	3-1/4	2-1/8	12
05660	3/16	3-1/2	2-5/16	12
05670	13/64	3-5/8	2-7/16	12
05680	7/32	3-3/4	2-1/2	12
05690	15/64	3-7/8	2-5/8	12
05700	1/4	4"	2-3/4	12
05710	17/64	4-1/8	2-7/8	12
05720	9/32	4-1/4	2-15/16	12
05730	19/64	4-3/8	3-1/16	6
05740	5/16	4-1/2	3-3/16	6
05750	21/64	4-5/8	3-5/16	6
05760	11/32	4-3/4	3-7/16	6
05770	23/64	4-7/8	3-1/2	6
05780	3/8	5"	3-5/8	6
05790	25/64	5-1/8	3-3/4	6
05800	13/32	5-1/4	3-7/8	6
05810	27/64	5-3/8	3-15/16	6
05820	7/16	5-1/2	4-1/16	6
05830	29/64	5-5/8	4-3/16	6
05840	15/32	5-3/4	4-5/16	6
05850	31/64	5-7/8	4-3/8	6
05860	1/2	6"	4-1/2	6
22210	33/64	6-5/8	4-13/16	1
22220	17/32	6-5/8	4-13/16	1
22230	35/64	6-5/8	4-13/16	1
22240	9/16	6-5/8	4-13/16	1
22250	37/64	6-5/8	4-13/16	1
22260	19/32	7-1/8	5-3/16	1
22270	39/64	7-1/8	5-3/16	1
22280	5/8	7-1/8	5-3/16	1
22290	41/64	7-1/8	5-3/16	1
22300	21/32	7-1/8	5-3/16	1
22310	43/64	7-5/8	5-5/8	1
22320	11/16	7-5/8	5-5/8	1
22330	45/64	7-5/8	5-5/8	1
22340	23/32	7-5/8	5-5/8	1
22350	47/64	7-5/8	5-5/8	1
22360	3/4	7-3/8	5-5/8	1

Larger sizes available in 280-UB section

LETTER

Part #	Letter Size	Overall Length Inches	Flute Length Inches	Qty. per/pack
39460	A	3-7/8	2-5/8	12
39470	B	4"	2-3/4	12
39480	C	4"	2-3/4	12
39490	D	4"	2-3/4	12
39500	E	4"	2-3/4	12
39510	F	4-1/8	2-7/8	12
39520	G	4-1/8	2-7/8	12
39530	H	4-1/8	2-7/8	12
39540	I	4-1/8	2-7/8	12
39550	J	4-1/8	2-7/8	12
39560	K	4-1/4	2-15/16	12
39570	L	4-1/4	2-15/16	12
39580	M	4-3/8	3-1/16	6
39590	N	4-3/8	3-1/16	6
39600	O	4-1/2	3-3/16	6
39610	P	4-5/8	3-5/16	6
39620	Q	4-3/4	3-7/16	6
39630	R	4-3/4	3-7/16	6
39640	S	4-7/8	3-1/2	6

Wire Continued Next Column

Part #	Diameter Inches	Overall Length Inches	Flute Length Inches	Qty. per/pack
39650	T	4-7/8	3-1/2	6
39660	U	5"	3-5/8	6
39670	V	5"	3-5/8	6
39680	W	5-1/8	3-3/4	6
39690	X	5-1/8	3-3/4	6
39700	Y	5-1/4	3-7/8	6
39710	Z	5-1/4	3-7/8	6

WIRE

Part #	Wire Sizes	Overall Length Inches	Flute Length Inches	Qty. per/pack
38940	1	3-7/8	2-5/8	12
38950	2	3-7/8	2-5/8	12
38960	3	3-3/4	2-1/2	12
38970	4	3-3/4	2-1/2	12
38980	5	3-3/4	2-1/2	12
38990	6	3-3/4	2-1/2	12
39000	7	3-5/8	2-7/16	12
39010	8	3-5/8	2-7/16	12
39020	9	3-5/8	2-7/16	12
39030	10	3-5/8	2-7/16	12
39040	11	3-1/2	2-5/16	12
39050	12	3-1/2	2-5/16	12
39060	13	3-1/2	2-5/16	12
39070	14	3-3/8	2-3/16	12
39080	15	3-3/8	2-3/16	12
39090	16	3-3/8	2-3/16	12
39100	17	3-3/8	2-3/16	12
39110	18	3-1/4	2-1/8	12
39120	19	3-1/4	2-1/8	12
39130	20	3-1/4	2-1/8	12
39140	21	3-1/4	2-1/8	12
39150	22	3-1/8	2"	12
39160	23	3-1/8	2"	12
39170	24	3-1/8	2"	12
39180	25	3"	1-7/8	12
39190	26	3"	1-7/8	12
39200	27	3"	1-7/8	12
39210	28	2-7/8	1-3/4	12
39220	29	2-7/8	1-3/4	12
39230	30	2-3/4	1-5/8	12
92310	31	2-3/4	1-5/8	12
92300	32	2-3/4	1-5/8	12
92290	33	2-5/8	1-1/2	12
92280	34	2-5/8	1-1/2	12
92270	35	2-5/8	1-1/2	12
92260	36	2-1/2	1-7/16	12
92250	37	2-1/2	1-7/16	12
92240	38	2-1/2	1-7/16	12
92230	39	2-3/8	1-3/8	12
92220	40	2-3/8	1-3/8	12
88420	41	2-3/8	1-3/8	12
88410	42	2-1/4	1-1/4	12
88400	43	2-1/4	1-1/4	12
88390	44	2-1/8	1-1/8	12
88380	45	2-1/8	1-1/8	12
88370	46	2-1/8	1-1/8	12
88360	47	2"	1"	12
88350	48	2"	1"	12
88340	49	2"	1"	12
88330	50	2"	1"	12
88320	51	2"	1"	12
88310	52	1-7/8	7/8	12
88300	53	1-7/8	7/8	12
88290	54	1-7/8	7/8	12
88280	55	1-7/8	7/8	12
88270	56	1-3/4	3/4	12
88260	57	1-3/4	3/4	12
88250	58	1-5/8	11/16	12
88240	59	1-5/8	11/16	12
88230	60	1-5/8	11/16	12

HSS CN-TECH NAS 907B & 3/8" REDUCED SHANK

Type 240-CN

CN-TECH™ CRYO/NITRIDE 135° Split Point

- Nitride process case hardening resulting in superior tool life and exceptional corrosion resistance.
- Cryogenic treatment at -300° F increases toughness while reducing brittleness.



Part #	Diameter Inches	Overall Length Inches	Flute Length Inches	Qty. per/pack
47032	1/16	1-7/8	7/8	12
47042	5/64"	2"	1"	12
47052	3/32	2-1/4	1-1/4	12
47062	7/64	2-5/8	1-1/2	12
47072	1/8	2-3/4	1-5/8	12
47082	9/64	2-7/8	1-3/4	12
47092	5/32"	3-1/8"	2"	12
47102	11/64	3-1/4	2-1/8	12
47112	3/16	3-1/2	2-5/16	12
47122	13/64	3-5/8	2-7/16	12
47132	7/32	3-3/4	2-1/2	12
47142	15/64	3-7/8	2-5/8	12
47152	1/4"	4"	2-3/4"	12
47162	17/64	4-1/8	2-7/8	12
47172	9/32	4-1/4	2-15/16	12
47182	19/64	4-3/8	3-1/16	6
47192	5/16	4-1/2	3-3/16	6
47202	21/64	4-5/8	3-5/16	6
47212	11/32	4-3/4	3-7/16	6
47222	23/64	4-7/8	3-1/2	6
47232	3/8"	5"	3-5/8"	6
47242	25/64	5-1/8	3-3/4	6
47252	13/32	5-1/4	3-7/8	6
47262	27/64	5-3/8	3-15/16	6
47272	7/16"	5-1/2	4-1/16	6
47282	29/64	5-5/8	4-3/16	6
47292	15/32	5-3/4	4-5/16	6
47302	31/64	5-7/8	4-3/8	6
47312	1/2"	6"	4-1/2"	6

LETTER

Part #	Letter Size	Overall Length Inches	Flute Length Inches	Qty. per/pack
47522	A	3-7/8	2-5/8	12
47532	B	4"	2-3/4	12
47542	C	4"	2-3/4	12
47552	D	4"	2-3/4	12
47562	E	4"	2-3/4	12
47572	F	4-1/8	2-7/8	12
47582	G	4-1/8	2-7/8	12
47592	H	4-1/8	2-7/8	12
47602	I	4-1/8	2-7/8	12
47612	J	4-1/8	2-7/8	12
47622	K	4-1/4	2-15/16	12
47632	L	4-1/4	2-15/16	12
47642	M	4-3/8	3-1/16	6
47652	N	4-3/8	3-1/16	6
47662	O	4-1/2	3-3/16	6
47672	P	4-5/8	3-5/16	6
47682	Q	4-3/4	3-7/16	6
47692	R	4-3/4	3-7/16	6
47702	S	4-7/8	3-1/2	6
47712	T	4-7/8	3-1/2	6
47722	U	5"	3-5/8	6
47732	V	5"	3-5/8	6
47742	W	5-1/8	3-3/4	6
47752	X	5-1/8	3-3/4	6
47762	Y	5-1/4	3-7/8	6
47772	Z	5-1/4	3-7/8	6

WIRE

Part #	Wire Sizes	Overall Length Inches	Flute Length Inches	Qty. per/pack
47782	1	3-7/8	2-5/8	12
47792	2	3-7/8	2-5/8	12
47802	3	3-3/4	2-1/2	12
47812	4	3-3/4	2-1/2	12
47822	5	3-3/4	2-1/2	12
47832	6	3-3/4	2-1/2	12
47842	7	3-5/8	2-7/16	12
47852	8	3-5/8	2-7/16	12
47862	9	3-5/8	2-7/16	12

Part #	Wire Sizes	Overall Length Inches	Flute Length Inches	Qty. per/pack
47872	10	3-5/8	2-7/16	12
47882	11	3-1/2	2-5/16	12
47892	12	3-1/2	2-5/16	12
47902	13	3-1/2	2-5/16	12
47912	14	3-3/8	2-3/16	12
47922	15	3-3/8	2-3/16	12
47932	16	3-3/8	2-3/16	12
47942	17	3-3/8	2-3/16	12
47952	18	3-1/4	2-1/8	12
47962	19	3-1/4	2-1/8	12
47972	20	3-1/4	2-1/8	12
47982	21	3-1/4	2-1/8	12
47992	22	3-1/8	2"	12
48002	23	3-1/8	2"	12
48012	24	3-1/8	2"	12
48022	25	3"	1-7/8	12
48032	26	3"	1-7/8	12
48042	27	3"	1-7/8	12
48052	28	2-7/8	1-3/4	12
48062	29	2-7/8	1-3/4	12
48072	30	2-3/4	1-5/8	12
48082	31	2-3/4	1-5/8	12
48092	32	2-3/4	1-5/8	12
48102	33	2-5/8	1-1/2	12
48112	34	2-5/8	1-1/2	12
48122	35	2-5/8	1-1/2	12
48132	36	2-1/2	1-7/16	12
48142	37	2-1/2	1-7/16	12
48152	38	2-1/2	1-7/16	12
48162	39	2-3/8	1-3/8	12
48172	40	2-3/8	1-3/8	12
48182	41	2-3/8	1-3/8	12
48192	42	2-1/4	1-1/4	12
48202	43	2-1/4	1-1/4	12
48212	44	2-1/8	1-1/8	12
48222	45	2-1/8	1-1/8	12
48232	46	2-1/8	1-1/8	12
48242	47	2"	1"	12
48252	48	2"	1"	12
48262	49	2"	1"	12
48272	50	2"	1"	12
48282	51	2"	1"	12
48292	52	1-7/8	7/8	12
48302	53	1-7/8	7/8	12
48312	54	1-7/8	7/8	12
48322	55	1-7/8	7/8	12
48332	56	1-3/4	3/4	12
48342	57	1-3/4	3/4	12
48352	58	1-5/8	11/16	12
48362	59	1-5/8	11/16	12
48372	60	1-5/8	11/16	12

Type 128-AG

3/8" Reduced Shank Magnum Super Premium

- 135° split point for fast penetration and accurate starting without center punch.
- Precision ground point, flutes, body, clearance and drill diameter for the ultimate in accuracy and performance.



Type 128-AG

Recommended for use in work hardening grades of stainless steel and other hard metal drilling applications

Part #	Diameter Inches	Overall Length Inches	Flute Length Inches	Qty. per/pack
59200	25/64	5-1/8	3-3/4	6
59210	13/32	5-1/4	3-7/8	6
59220	27/64	5-3/8	3-15/16	6
59230	7/16	5-1/2	4-1/16	6
59240	29/64	5-5/8	4-3/16	6
59250	15/32	5-3/4	4-5/16	6
59260	31/64	5-7/8	4-3/8	6
59270	1/2	6"	4-1/2	6
59280	17/32	6"	4-1/4	1
59290	9/16	6"	4-1/4	1
59300	19/32	6"	4-1/4	1
59310	5/8	6"	4-1/4	1

These items are also available carded. See Price List Catalog for details.

Jobber Length

NAS 907B - METRIC

Type 170-AG

Magnum Super Premium - 135° Split Point, NAS 907B

- 135° split point provides fast penetration and accurate starting without a center punch.
- Withstands substantially higher drilling temperatures while maintaining sharpness.



Type 170-AG

Recommended for use in work hardening grades of stainless steel and other hard metal drilling applications.

METRIC

Part No.	Dia. MM	Overall Length		Flute Length		Qty. per/pack	Part No.	Dia. MM	Overall Length		Flute Length		Qty. per/pack
		MM	Inches	MM	Inches				MM	Inches	MM	Inches	
48760	0.70	32	1-1/4	10	25/64	10	49270	4.00	83	3-1/4	54	2-1/8	10
48780	0.80	35	1-3/8	13	1/2	10	49280	4.10	83	3-1/4	54	2-1/8	10
48790	0.85	38	1-1/2	16	5/8	10	49290	4.20	83	3-1/4	54	2-1/8	10
48800	0.90	38	1-1/2	16	5/8	10	49300	4.30	83	3-1/4	54	2-1/8	10
49990	0.95	38	1-1/2	16	5/8	10	49310	4.40	86	3-3/8	56	2-13/64	10
48690	0.98	38	1-1/2	16	5/8	10	49320	4.50	86	3-3/8	56	2-13/64	10
48820	1.00	41	1-5/8	17	11/16	10	49330	4.60	86	3-3/8	56	2-13/64	10
48750	1.05	41	1-5/8	17	11/16	10	49340	4.70	89	3-1/2	59	2-21/64	10
48840	1.10	44	1-3/4	19	3/4	10	49350	4.80	89	3-1/2	59	2-21/64	10
48850	1.15	44	1-3/4	19	3/4	10	49360	4.90	92	3-5/8	62	2-7/16	10
23270	1.18	44	1-3/4	19	3/4	10	49370	5.00	92	3-5/8	62	2-7/16	10
48860	1.20	48	1-7/8	22	7/8	10	49380	5.10	92	3-5/8	62	2-7/16	10
48870	1.25	48	1-7/8	22	7/8	10	49390	5.20	95	3-3/4	64	2-1/2	10
48880	1.30	48	1-7/8	22	7/8	10	49400	5.30	95	3-3/4	64	2-1/2	10
48890	1.35	48	1-7/8	22	7/8	10	49410	5.40	95	3-3/4	64	2-1/2	10
48900	1.40	48	1-7/8	22	7/8	10	49420	5.50	95	3-3/4	64	2-1/2	10
48910	1.45	48	1-7/8	22	7/8	10	49430	5.60	98	3-7/8	67	2-5/8	10
48920	1.50	48	1-7/8	22	7/8	10	49440	5.70	98	3-7/8	67	2-5/8	10
48930	1.55	48	1-7/8	22	7/8	10	49450	5.80	98	3-7/8	67	2-5/8	10
48940	1.60	48	1-7/8	22	7/8	10	49460	5.90	98	3-7/8	67	2-5/8	10
48950	1.65	51	2"	25	1"	10	49470	6.00	102	4"	70	2-3/4	10
48960	1.70	51	2"	25	1"	10	49480	6.10	102	4"	70	2-3/4	10
48970	1.75	51	2"	25	1"	10	49490	6.20	102	4"	70	2-3/4	10
48980	1.80	51	2"	25	1"	10	49500	6.30	102	4"	70	2-3/4	10
49000	1.90	51	2"	25	1"	10	49510	6.40	105	4-1/8	73	2-7/8	10
49010	1.95	51	2"	25	1"	10	49520	6.50	105	4-1/8	73	2-7/8	10
49020	2.00	51	2"	25	1"	10	49530	6.60	105	4-1/8	73	2-7/8	10
49030	2.05	54	2-1/8	29	1-5/32	10	49540	6.70	105	4-1/8	73	2-7/8	10
49040	2.10	54	2-1/8	29	1-5/32	10	49550	6.80	105	4-1/8	73	2-7/8	10
49060	2.20	57	2-1/4	32	1-1/4	10	49560	6.90	105	4-1/8	73	2-7/8	10
49080	2.30	57	2-1/4	32	1-1/4	10	49570	7.00	105	4-1/8	73	2-7/8	10
49100	2.40	60	2-23/64	35	1-3/8	10	49580	7.10	108	4-1/4	75	2-61/64	10
49120	2.50	60	2-23/64	35	1-3/8	10	49590	7.20	108	4-1/4	75	2-61/64	10
49130	2.60	64	2-1/2	37	1-29/64	10	49600	7.30	108	4-1/4	75	2-61/64	10
49140	2.70	64	2-1/2	37	1-15/32	10	49610	7.40	111	4-3/8	78	3"	10
49150	2.80	67	2-5/8	38	1-1/2	10	49620	7.50	111	4-3/8	78	3"	5
49160	2.90	70	2-3/4	41	1-5/8	10	49630	7.60	111	4-3/8	78	3"	5
49170	3.00	70	2-3/4	41	1-5/8	10	49640	7.70	114	4-1/2	81	3-3/16	5
49180	3.10	70	2-3/4	41	1-5/8	10	49650	7.80	114	4-1/2	81	3-3/16	5
49190	3.20	70	2-3/4	41	1-5/8	10	49660	7.90	114	4-1/2	81	3-3/16	5
49200	3.30	73	2-7/8	45	1-3/4	10	49670	8.00	114	4-1/2	81	3-3/16	5
49210	3.40	73	2-7/8	45	1-3/4	10	49680	8.10	117	4-9/16	84	3-5/16	5
49220	3.50	73	2-7/8	45	1-3/4	10	49690	8.20	117	4-9/16	84	3-5/16	5
49230	3.60	76	3"	48	1-7/8	10	49700	8.30	117	4-9/16	84	3-5/16	5
49240	3.70	76	3"	48	1-7/8	10	49710	8.40	121	4-3/4	87	3-27/64	5
49250	3.80	76	3"	48	1-7/8	10							
49260	3.90	79	3-1/8	51	2"	10							

Metric sizes continued on page 9

NAS 907B - METRIC & HIGH HELIX FLUTES



Type 170-AG

Recommended for use in work hardening grades of stainless steel and other hard metal drilling applications.

Type 170-AG

Magnum Super Premium
- NAS 907B 135° Split Point

- 135° split point provides fast penetration and accurate starting without a center punch.
- Withstands substantially higher drilling temperatures while maintaining sharpness.

METRIC

Part No.	Dia. MM	Overall Length		Flute Length		Qty. per/pack
		MM	Inches	MM	Inches	
49720	8.50	121	4-3/4	87	3-27/64	5
49730	8.60	121	4-3/4	87	3-27/64	5
49740	8.70	121	4-3/4	87	3-27/64	5
49750	8.80	124	4-7/8	89	3-1/2	5
49760	8.90	124	4-7/8	89	3-1/2	5
49770	9.00	124	4-7/8	89	3-1/2	5
49780	9.10	124	4-7/8	89	3-1/2	5
49790	9.20	127	5"	92	3-5/8	5
49800	9.30	127	5"	92	3-5/8	5
49810	9.40	127	5"	92	3-5/8	5
49820	9.50	127	5"	92	3-5/8	5
49830	9.60	130	5-1/8	95	3-3/4	5
49840	9.70	130	5-1/8	95	3-3/4	5
49850	9.80	130	5-1/8	95	3-3/4	5
49860	9.90	130	5-1/8	95	3-3/4	5
49870	10.00	130	5-1/8	95	3-3/4	5
12450	10.10	130	5-1/8	95	3-3/4	5
49880	10.20	133	5-15/64	98	3-7/8	5
12510	10.30	133	5-15/64	98	3-7/8	5
50220	10.40	133	5-15/64	98	3-7/8	5
49890	10.50	133	5-15/64	98	3-7/8	5
12460	10.60	133	5-15/64	98	3-7/8	5
50230	10.70	133	5-1/4	98	3-5/8	5
49900	10.80	140	5-1/2	103	4-1/16	5

Part No.	Dia. MM	Overall Length		Flute Length		Qty. per/pack
		MM	Inches	MM	Inches	
12470	10.90	140	5-1/2	103	4-1/16	5
49910	11.00	140	5-1/2	103	4-1/16	5
12480	11.10	140	5-1/2	103	4-1/16	5
49920	11.20	143	5-5/8	106	4-7/32	5
50240	11.30	143	5-5/8	106	4-7/32	5
12490	11.40	143	5-5/8	106	4-7/32	5
49930	11.50	143	5-5/8	106	4-7/32	5
12500	11.60	143	5-5/8	106	4-7/32	5
50250	11.70	146	5-3/4	110	4-11/32	5
49940	11.80	146	5-3/4	110	4-11/32	5
12520	11.90	146	5-3/4	110	4-11/32	5
49950	12.00	149	5-7/8	111	4-3/8	5
12530	12.10	149	5-7/8	111	4-3/8	5
49960	12.20	149	5-7/8	111	4-3/8	5
50260	12.30	149	5-7/8	111	4-3/8	5
12540	12.40	149	5-7/8	111	4-3/8	5
49970	12.50	152	6"	114	4-1/2	5
12550	12.60	152	6"	114	4-1/2	5
12570	12.70	152	6"	114	4-1/2	5
50270	12.80	152	6"	114	4-1/2	5
12560	12.90	152	6"	114	4-1/2	5
49980	13.00	152	6"	114	4-1/2	5

Larger sizes in **Metric 130-AGM** section page 46

HIGH HELIX FLUTES



Type 190-SS

Magnum Super Premium
135° Split Point

- High Helix Flute design allows for increased feed rates.
- 135° split point provides fast penetration and accurate starting without a center punch.
- Recommended for stainless steel, aluminum, brass and all other non-ferrous metals.

Part No.	Diameter Inches	Overall Length		Flute Length		Qty. per/pack
		Inches	Inches	Inches	Inches	
41301	1/16"	1-7/8	7/8			12
41311	5/64"	2"	1"			12
41321	3/32"	2-1/4	1-1/4			12
41331	7/64"	2-5/8	1-1/2			12
41341	1/8"	2-3/4	1-5/8			12
41351	9/64"	2-7/8	1-3/4			12
41361	5/32"	3-1/8"	2"			12
41371	11/64"	3-1/4	2-1/8			12
41381	3/16"	3-1/2	2-5/16			12
41391	13/64"	3-5/8	2-7/16			12
41401	7/32"	3-3/4	2-1/2			12
41411	15/64"	3-7/8	2-5/8			12
41421	1/4"	4"	2-3/4"			12
41431	17/64"	4-1/8	2-7/8			12
41441	9/32"	4-1/4	2-15/16			12

Part No.	Diameter Inches	Overall Length		Flute Length		Qty. per/pack
		Inches	Inches	Inches	Inches	
41451	19/64"	4-3/8	3-1/16			6
41461	5/16"	4-1/2	3-3/16			6
41471	21/64"	4-5/8	3-5/16			6
41481	11/32"	4-3/4	3-7/16			6
41491	23/64"	4-7/8	3-1/2			6
41501	3/8"	5"	3-5/8"			6
41511	25/64"	5-1/8	3-3/4			6
41521	13/32"	5-1/4	3-7/8			6
41531	27/64"	5-3/8	3-15/16			6
41541	7/16"	5-1/2	4-1/16			6
41551	29/64"	5-5/8	4-3/16			6
41561	15/32"	5-3/4	4-5/16			6
41571	31/64"	5-7/8	4-3/8			6
41581	1/2"	6"	4-1/2"			6

Jobber Length

HSS HEAVY-DUTY NAS 907B

Type 190, Type 190-AN Titanium Nitride Coated

135° Split Point

- Heavy-duty construction for drilling in tougher materials
- Manufactured from premium high-speed steel
- 135° split point is self-centering for reduce thrust and easier penetration
- Manufactured to **NAS 907B** aerospace specification



Type 190

Black oxide surface finish increases wear resistance and adds lubricity to improve chip flow.



Type 190-AN

Titanium nitride (TiN) coating adds lubricity and hardness, enhancing chip flow, finish hole quality and drill life.

FRACTIONAL

Type 190 Black Oxide Part Number	Type 190-AN Titanium Nitride Part Number	Diameter Inches	Overall Length Inches	Flute Length Inches	Type 190 Black Oxide Qty. per/Pack	Type 190-AN Titanium Nitride Qty. per/Pack
04490	97890	1/16	1-7/8	7/8	12	6
04500	97880	5/64	2	1	12	6
04510	97870	3/32	2-1/4	1-1/4	12	6
04520	97860	7/64	2-5/8	1-1/2	12	6
04530	97850	1/8	2-3/4	1-5/8	12	6
04540	97840	9/64	2-7/8	1-3/4	12	6
04550	97830	5/32	3-1/8	2	12	6
04560	97820	11/64	3-1/4	2-1/8	12	6
04570	97810	3/16	3-1/2	2-5/16	12	6
04580	97800	13/64	3-5/8	2-7/16	12	6
04590	97790	7/32	3-3/4	2-1/2	12	6
04600	97780	15/64	3-7/8	2-5/8	12	6
04610	97770	1/4	4	2-3/4	12	6
04620	97760	17/64	4-1/8	2-7/8	12	6
04630	97750	9/32	4-1/4	2-15/16	12	6
04640	97740	19/64	4-3/8	3-1/16	6	3
04650	97730	5/16	4-1/2	3-3/16	6	3
04660	97720	21/64	4-5/8	3-5/16	6	3
04670	97710	11/32	4-3/4	3-7/16	6	3
04680	97700	23/64	4-7/8	3-1/2	6	3
04690	97690	3/8	5	3-5/8	6	3
04700	97680	25/64	5-1/8	3-3/4	6	3
04710	97670	13/32	5-1/4	3-7/8	6	3
04720	97660	27/64	5-3/8	3-15/16	6	3
04730	97650	7/16	5-1/2	4-1/16	6	3
04740	97640	29/64	5-5/8	4-3/16	6	3
04750	97630	15/32	5-3/4	4-5/16	6	3
04760	97620	31/64	5-7/8	4-3/8	6	3
04770	97610	1/2	6	4-1/2	6	3

LETTER

Type 190 Black Oxide Part Number	Type 190-AN Titanium Nitride Part Number	Letter Sizes	Overall Length Inches	Flute Length Inches	Type 190 Black Oxide Qty. per/pack	Type 190-AN Titanium Nitride Qty. per/pack
05300	95710	A	3-7/8	2-5/8	12	6
05310	95700	B	4	2-3/4	12	6
05320	95690	C	4	2-3/4	12	6
05330	95680	D	4	2-3/4	12	6
05340	95670	E	4	2-3/4	12	6
05350	95660	F	4-1/8	2-7/8	12	6
05360	95650	G	4-1/8	2-7/8	12	6
05370	95640	H	4-1/8	2-7/8	12	6
05380	95630	I	4-1/8	2-7/8	12	6
05390	95620	J	4-1/8	2-7/8	12	6
05400	95610	K	4-1/4	2-15/16	12	6
05410	95600	L	4-1/4	2-15/16	12	6
05420	95590	M	4-3/8	3-1/16	6	3
05430	95580	N	4-3/8	3-1/16	6	3
05440	95570	O	4-1/2	3-3/16	6	3
05450	95560	P	4-5/8	3-5/16	6	3
05460	95550	Q	4-3/4	3-7/16	6	3
05470	95540	R	4-3/4	3-7/16	6	3
05480	95530	S	4-7/8	3-1/2	6	3

Letter sizes continued on page 11.

TiN

HSS Twist Drills - Heavy Duty HSS NAS 907B

HSS HEAVY-DUTY NAS 907B Type 190, Type 190-AN Titanium Nitride Coated 135° Split Point



Type 190

Black oxide surface finish increases wear resistance and adds lubricity to improve chip flow.



Type 190-AN

Titanium nitride (TiN) coating adds lubricity and hardness, enhancing chip flow, finish hole quality and drill life.

- Heavy-duty construction for drilling in tougher materials
 - Manufactured from premium high-speed steel
- 135° split point is self-centering for reducing thrust and easier penetration
 - Manufactured to NAS 907B aerospace specification

LETTER

Type 190 Black Oxide Part Number	Type 190-AN TiN Coated Part Number	Letter Sizes	Overall Length Inches	Flute Length Inches	Type 190 Black Oxide Qty. per/pack	Type 190-AN Titanium Nitride Qty. per/pack
05490	95520	T	4-7/8	3-1/2	6	3
05500	95510	U	5	3-5/8	6	3
05510	95500	V	5	3-5/8	6	3
05520	95490	W	5-1/8	3-3/4	6	3
05530	95480	X	5-1/8	3-3/4	6	3
05540	95470	Y	5-1/4	3-7/8	6	3
05550	95460	Z	5-1/4	3-7/8	6	3

WIRE

Type 190 Black Oxide Part Number	Type 190-AN TiN Coated Part Number	Letter Sizes	Overall Length Inches	Flute Length Inches	Type 190 Black Oxide Qty. per/pack	Type 190-AN TiN Coated Qty. per/pack
04780	98520	1	3-7/8	2-5/8	12	6
04790	98510	2	3-7/8	2-5/8	12	6
04800	98500	3	3-3/4	2-1/2	12	6
04810	98490	4	3-3/4	2-1/2	12	6
04820	98480	5	3-3/4	2-1/2	12	6
04830	98470	6	3-3/4	2-1/2	12	6
04840	98460	7	3-5/8	2-7/16	12	6
04850	98450	8	3-5/8	2-7/16	12	6
04860	98440	9	3-5/8	2-7/16	12	6
04870	98430	10	3-5/8	2-7/16	12	6
04880	98420	11	3-1/2	2-5/16	12	6
04890	98410	12	3-1/2	2-5/16	12	6
04900	98400	13	3-1/2	2-5/16	12	6
04910	98390	14	3-3/8	2-3/16	12	6
04920	98380	15	3-3/8	2-3/16	12	6
04930	98370	16	3-3/8	2-3/16	12	6
04940	98360	17	3-3/8	2-3/16	12	6
04950	98350	18	3-1/4	2-1/8	12	6
04960	98340	19	3-1/4	2-1/8	12	6
04970	98330	20	3-1/4	2-1/8	12	6
04980	98320	21	3-1/4	2-1/8	12	6
04990	98310	22	3-1/8	2	12	6
05000	98300	23	3-1/8	2	12	6
05010	98290	24	3-1/8	2	12	6
05020	98280	25	3	1-7/8	12	6
05030	98270	26	3	1-7/8	12	6
05040	98260	27	3	1-7/8	12	6
05050	98250	28	2-7/8	1-3/4	12	6
05060	98240	29	2-7/8	1-3/4	12	6
05070	98230	30	2-3/4	1-5/8	12	6
05080	98220	31	2-3/4	1-5/8	12	6
05090	98210	32	2-3/4	1-5/8	12	6
05100	98200	33	2-5/8	1-1/2	12	6
05110	98190	34	2-5/8	1-1/2	12	6
05120	98180	35	2-5/8	1-1/2	12	6
05130	98170	36	2-1/2	1-7/16	12	6
05140	98160	37	2-1/2	1-7/16	12	6
05150	98150	38	2-1/2	1-7/16	12	6
05160	98140	39	2-3/8	1-3/8	12	6
05170	98130	40	2-3/8	1-3/8	12	6
05180	98120	41	2-3/8	1-3/8	12	6
05190	98110	42	2-1/4	1-1/4	12	6
05200	98100	43	2-1/4	1-1/4	12	6
05210	98090	44	2-1/8	1-1/8	12	6
05220	98080	45	2-1/8	1-1/8	12	6
05230	98070	46	2-1/8	1-1/8	12	6
05240	98060	47	2	1	12	6
05250	98050	48	2	1	12	6
05260	98040	49	2	1	12	6
05270	98030	50	2	1	12	6
05280	98020	51	2	1	12	6
05290	98010	52	1-7/8	7/8	12	6

Jobber Length

HSS HEAVY-DUTY NAS 907B

Type 190-ACN Titanium Carbon Nitride

Type 190-ALN Titanium Aluminum Nitride

- Heavy-duty construction for drilling in tougher materials
- Manufactured from premium high-speed steel
- 135° split point is self-centering for reducing thrust and easier penetration
- Provides exceptional oxidation resistance and extreme hardness
- TiCN is harder and has a lower coefficient of friction than TiN coating.
- Recommended where moderate temperatures are generated.
- Manufactured to **NAS 907B** aerospace specification



TiCN Coating

Titanium carbon nitride (TiCN) coating raises cutting surface hardness greatly increasing resistance to wear.



TiAlN Coating

Titanium aluminum nitride (TiAlN) designed for use in high temperature operations and difficult to machine material

FRACTIONAL

Type 190-ACN TiCN Coated Part Number	Type 190-ALN TiAlN Coated Part Number	Diameter Inches	Overall Length Inches	Flute Length Inches	Qty. per/Pack
80002	80000	1/16	1-7/8	7/8	6
80012	80010	5/64	2	1	6
80022	80020	3/32	2-1/4	1-1/4	6
80032	80030	7/64	2-5/8	1-1/2	6
80042	80040	1/8	2-3/4	1-5/8	6
80052	80050	9/64	2-7/8	1-3/4	6
80062	80060	5/32	3-1/8	2	6
80072	80070	11/64	3-1/4	2-1/8	6
80082	80080	3/16	3-1/2	2-5/16	6
80092	80090	13/64	3-5/8	2-7/16	6
80102	80100	7/32	3-3/4	2-1/2	6
80112	80110	15/64	3-7/8	2-5/8	6
80122	80120	1/4	4	2-3/4	6
80132	80130	17/64	4-1/8	2-7/8	6
80142	80140	9/32	4-1/4	2-15/16	6
80152	80150	19/64	4-3/8	3-1/16	3
80162	80160	5/16	4-1/2	3-3/16	3
80172	80170	21/64	4-5/8	3-5/16	3
80182	80180	11/32	4-3/4	3-7/16	3
80192	80190	23/64	4-7/8	3-1/2	3
80202	80200	3/8	5	3-5/8	3
80212	80210	25/64	5-1/8	3-3/4	3
80222	80220	13/32	5-1/4	3-7/8	3
80232	80230	27/64	5-3/8	3-15/16	3
80242	80240	7/16	5-1/2	4-1/16	3
80252	80250	29/64	5-5/8	4-3/16	3
80262	80260	15/32	5-3/4	4-5/16	3
80272	80270	31/64	5-7/8	4-3/8	3
80282	80280	1/2	6	4-1/2	3

LETTER

Type 190- ACN TiCN Coated Part Number	Type 190-ALN TiAlN Coated Part Number	Diameter Inches	Overall Length Inches	Flute Length Inches	Qty. per/Pack
80292	80290	A	3-7/8	2-5/8	6
80302	80300	B	4	2-3/4	6
80312	80310	C	4	2-3/4	6
80322	80320	D	4	2-3/4	6
80332	80330	E	4	2-3/4	6
80342	80340	F	4-1/8	2-7/8	6
80352	80350	G	4-1/8	2-7/8	6
80362	80360	H	4-1/8	2-7/8	6
80372	80370	I	4-1/8	2-7/8	6
80382	80380	J	4-1/8	2-7/8	6
80392	80390	K	4-1/4	2-15/16	6
80402	80400	L	4-1/4	2-15/16	6
80412	80410	M	4-3/8	3-1/16	3
80422	80420	N	4-3/8	3-1/16	3
80432	80430	O	4-1/2	3-3/16	3

Letter sizes continued on page 13

TiCN / TiAlN

Twist Drills - HSS Heavy-Duty NAS 907B

HSS HEAVY-DUTY NAS 907B

Type 190-ACN Titanium Carbon Nitride
Type 190-ALN Titanium Aluminum Nitride



TiCN Coating

Titanium carbon nitride (TiCN) coating raises cutting surface hardness greatly increasing resistance to wear.



TiAlN Coating

Titanium aluminum nitride (TiAlN) designed for use in high temperature operations and difficult to machine material

- Heavy-duty construction for drilling in tougher materials
 - Manufactured from premium high-speed steel
- 135° split point is self-centering for reducing thrust and easier penetration
- Provides exceptional oxidation resistance and extreme hardness
- TiCN is harder and has a lower coefficient of friction than TiN coating.
 - Recommended where moderate temperatures are generated.
- Manufactured to **NAS 907B** aerospace specification

LETTER

Type 190- ACN TiCN Coated Part Number	Type 190-ALN TiAlN Coated Part Number	Diameter Inches	Overall Length Inches	Flute Length Inches	Qty. per/Pack
80442	80440	P	4-5/8	3-5/16	3
80452	80450	Q	4-3/4	3-7/16	3
80462	80460	R	4-3/4	3-7/16	3
80472	80470	S	4-7/8	3-1/2	3
80482	80480	T	4-7/8	3-1/2	3
80492	80490	U	5	3-5/8	3
80502	80500	V	5	3-5/8	3
80512	80510	W	5-1/8	3-3/4	3
80522	80520	X	5-1/8	3-3/4	3
80532	80530	Y	5-1/4	3-7/8	3
80542	80540	Z	5-1/4	3-7/8	3

WIRE

Type 190- ACN TiCN Coated Part Number	Type 190-ALN TiAlN Coated Part Number	Diameter Inches	Overall Length Inches	Flute Length Inches	Qty. per/Pack
80552	80550	1	3-7/8	2-5/8	6
80562	80560	2	3-7/8	2-5/8	6
80572	80570	3	3-3/4	2-1/2	6
80582	80580	4	3-3/4	2-1/2	6
80592	80590	5	3-3/4	2-1/2	6
80602	80600	6	3-3/4	2-1/2	6
80612	80610	7	3-5/8	2-7/16	6
80622	80620	8	3-5/8	2-7/16	6
80632	80630	9	3-5/8	2-7/16	6
80642	80640	10	3-5/8	2-7/16	6
80652	80650	11	3-1/2	2-5/16	6
80662	80660	12	3-1/2	2-5/16	6
80672	80670	13	3-1/2	2-5/16	6
80682	80680	14	3-3/8	2-3/16	6
80692	80690	15	3-3/8	2-3/16	6
80702	80700	16	3-3/8	2-3/16	6
80712	80710	17	3-3/8	2-3/16	6
80722	80720	18	3-1/4	2-1/8	6
80732	80730	19	3-1/4	2-1/8	6
80742	80740	20	3-1/4	2-1/8	6
80752	80750	21	3-1/4	2-1/8	6
80762	80760	22	3-1/8	2	6
80772	80770	23	3-1/8	2	6
80782	80780	24	3-1/8	2	6
80792	80790	25	3	1-7/8	6
80802	80800	26	3	1-7/8	6
80812	80810	27	3	1-7/8	6
80822	80820	28	2-7/8	1-3/4	6
80832	80830	29	2-7/8	1-3/4	6
80842	80840	30	2-3/4	1-5/8	6
80852	80850	31	2-3/4	1-5/8	6
80862	80860	32	2-3/4	1-5/8	6
80872	80870	33	2-5/8	1-1/2	6
80882	80880	34	2-5/8	1-1/2	6
80892	80890	35	2-5/8	1-1/2	6
80902	80900	36	2-1/2	1-7/16	6

Wire sizes continued on page 14

Jobber Length

HSS HEAVY-DUTY NAS 907B

Type 190-ACN Titanium Carbon Nitride

Type 190-ALN Titanium Aluminum Nitride

- Heavy-duty construction for drilling in tougher materials
- Manufactured from premium high-speed steel
- 135° split point is self-centering for reducing thrust and easier penetration
- Provides exceptional oxidation resistance and extreme hardness
- TiCN is harder and has a lower coefficient of friction than TiN coating.
- Recommended where moderate temperatures are generated.
- Manufactured to **NAS 907B** aerospace specification



TiCN Coating

Titanium carbon nitride (TiCN) coating raises cutting surface hardness greatly increasing resistance to wear.



TiAlN Coating

Titanium aluminum nitride (TiAlN) designed for use in high temperature operations and difficult to machine material

WIRE

Type 190- ACN TiCN Coated Part Number	Type 190-ALN TiAlN Coated Part Number	Diameter Inches	Overall Length Inches	Flute Length Inches	Qty. per/Pack
80912	80910	37	2-1/2	1-7/16	6
80922	80920	38	2-1/2	1-7/16	6
80932	80930	39	2-3/8	1-3/8	6
80942	80940	40	2-3/8	1-3/8	6
80952	80950	41	2-3/8	1-3/8	6
80962	80960	42	2-1/4	1-1/4	6
80972	80970	43	2-1/4	1-1/4	6
80982	80980	44	2-1/8	1-1/8	6
80992	80990	45	2-1/8	1-1/8	6
81002	81000	46	2-1/8	1-1/8	6
81012	81010	47	2	1	6
81022	81020	48	2	1	6
81032	81030	49	2	1	6
81042	81040	50	2	1	6
81052	81050	51	2	1	6
81062	81060	52	1-7/8	7/8	6

TiCN / TiAlN

Twist Drills - HSS Heavy-Duty NAS 907B

GOLDSTRIKE™ & V-LINE HEAVY DUTY

Type 190-GF

GOLDSTRIKE™

Premium - 135° Split Point

Gold Surface Treated 3-Flats on Shank, 3/16" and Larger

- Heavy-duty 135° split point drills perform well in very demanding applications.
- Ideal for use with hand held drills with key-less chucks.



Type 190-GF

Heavy-duty construction makes it ideal for difficult to drill materials.

Type 198

V-Line - Heavy-Duty Black Oxide 135° Split Point

- American made value line drill.
- 135° split point drills are self centering and perform well in harder metals.
- Heavy-duty construction makes this series of drills ideal for the medium to light tensile strength metal drilling applications.



Type 198

Designed for the user whose applications are well served without the need for the tighter tolerances of our standard Type 190.

FRACTIONAL

Part #	Diameter Inches	Overall Length Inches	Flute Length Inches	Qty. per/pack
40490	1/16	1-7/8	7/8	12
40500	5/64	2	1	12
40510	3/32	2-1/4	1-1/4	12
40520	7/64	2-5/8	1-1/2	12
40530	1/8	2-3/4	1-5/8	12
40540	9/64	2-7/8	1-3/4	12
40550	5/32	3-1/8	2	12
40560	11/64	3-1/4	2-1/8	12
40561	3/16	3-1/2	2-5/16	12
40562	13/64	3-5/8	2-7/16	12
40563	7/32	3-3/4	2-1/2	12
40564	15/64	3-7/8	2-5/8	12
40569	1/4	4	2-3/4	12
40571	17/64	4-1/8	2-7/8	12
40572	9/32	4-1/4	2-15/16	12
40573	19/64	4-3/8	3-1/16	6
40574	5/16	4-1/2	3-3/16	6
40579	21/64	4-5/8	3-5/16	6
40581	11/32	4-3/4	3-7/16	6
40582	23/64	4-7/8	3-1/2	6
40583	3/8	5	3-5/8	6
40584	25/64	5-1/8	3-3/4	6
40589	13/32	5-1/4	3-7/8	6
40591	27/64	5-3/8	3-15/16	6
40592	7/16	5-1/2	4-1/16	6
40593	29/64	5-5/8	4-3/16	6
40594	15/32	5-3/4	4-5/16	6
40601	31/64	5-7/8	4-3/8	6
40602	1/2	6	4-1/2	6

FRACTIONAL

Part #	Diameter Inches	Overall Length Inches	Flute Length Inches	Qty. per/pack
02782	1/16	1-7/8	7/8	12
02792	5/64	2	1	12
02802	3/32	2-1/4	1-1/4	12
02812	7/64	2-5/8	1-1/2	12
02822	1/8	2-3/4	1-5/8	12
02832	9/64	2-7/8	1-3/4	12
02842	5/32	3-1/8	2	12
02852	11/64	3-1/4	2-1/8	12
02862	3/16	3-1/2	2-5/16	12
02872	13/64	3-5/8	2-7/16	12
02882	7/32	3-3/4	2-1/2	12
02892	15/64	3-7/8	2-5/8	12
02902	1/4	4	2-3/4	12
02912	17/64	4-1/8	2-7/8	12
02922	9/32	4-1/4	2-15/16	12
02932	19/64	4-3/8	3-1/16	6
02942	5/16	4-1/2	3-3/16	6
02952	21/64	4-5/8	3-5/16	6
02962	11/32	4-3/4	3-7/16	6
02972	23/64	4-7/8	3-1/2	6
02982	3/8	5	3-5/8	6
02992	25/64	5-1/8	3-3/4	6
03002	13/32	5-1/4	3-7/8	6
03012	27/64	5-3/8	3-15/16	6
03022	7/16	5-1/2	4-1/16	6
03032	29/64	5-5/8	4-3/16	6
03042	15/32	5-3/4	4-5/16	6
03052	31/64	5-7/8	4-3/8	6
03062	1/2	6	4-1/2	6

Type 190-GFR

GOLDSTRIKE™ Reduced Shank -

135° Split Point with 3/8" Reduced Shank with Flats



3/8" WITH FLATS ON SHANK

Part #	Description of Sizes	Per Pack	Part #	Description of Sizes	Per Pack
40633	25/64	6	40622	29/64	6
40634	13/32	6	40623	15/32	6
40639	27/64	6	40624	31/64	6
40621	7/16	6	40629	1/2	6

Jobber Length

HSS BLACK OXIDE 118° SPLIT POINT NAS 907A

Type 340-A

- 118° split point is self-centering for reduced thrust and easier penetration
- Black oxide finish for increased wear resistance and added lubricity
- Manufactured to **NAS 907A** aerospace specification



Type 340-A

General-purpose geometry with 118° split point for drilling in a wide range of drilling operations and materials.

FRACTIONAL

Part #	Diameter Inches	Overall Length Inches	Flute Length Inches	Qty. per/pack
35730	1/16	1-7/8	7/8	12
35740	5/64	2	1	12
35750	3/32	2-1/4	1-1/4	12
35760	7/64	2-5/8	1-1/2	12
35770	1/8	2-3/4	1-5/8	12
35780	9/64	2-7/8	1-3/4	12
35790	5/32	3-1/8	2	12
35800	11/64	3-1/4	2-1/8	12
35810	3/16	3-1/2	2-5/16	12
35820	13/64	3-5/8	2-7/16	12
35830	7/32	3-3/4	2-1/2	12
35840	15/64	3-7/8	2-5/8	12
35850	1/4	4	2-3/4	12
35860	17/64	4-1/8	2-7/8	12
35870	9/32	4-1/4	2-15/16	12
35880	19/64	4-3/8	3-1/16	6
35890	5/16	4-1/2	3-3/16	6
35900	21/64	4-5/8	3-5/16	6
35910	11/32	4-3/4	3-7/16	6
35920	23/64	4-7/8	3-1/2	6
35930	3/8	5	3-5/8	6
35940	25/64	5-1/8	3-3/4	6
35950	13/32	5-1/4	3-7/8	6
35960	27/64	5-3/8	3-15/16	6
35970	7/16	5-1/2	4-1/16	6
35980	29/64	5-5/8	4-3/16	6
35990	15/32	5-3/4	4-5/16	6
36000	31/64	5-7/8	4-3/8	6
36010	1/2	6	4-1/2	6

LETTER

Part #	Letter Sizes	Overall Length Inches	Flute Length Inches	Qty. per/pack
82750	A	3-7/8	2-5/8	12
82760	B	4	2-3/4	12
82770	C	4	2-3/4	12
82780	D	4	2-3/4	12
82790	E	4	2-3/4	12
82800	F	4-1/8	2-7/8	12
82810	G	4-1/8	2-7/8	12
82820	H	4-1/8	2-7/8	12
82830	I	4-1/8	2-7/8	12
82840	J	4-1/8	2-7/8	12
82850	K	4-1/4	2-15/16	12
82860	L	4-1/4	2-15/16	12
82870	M	4-3/8	3-1/16	6
82880	N	4-3/8	3-1/16	6
82890	O	4-1/2	3-3/16	6
82900	P	4-5/8	3-5/16	6
82910	Q	4-3/4	3-7/16	6
82920	R	4-3/4	3-7/16	6
82930	S	4-7/8	3-1/2	6
82940	T	4-7/8	3-1/2	6
82950	U	5	3-5/8	6
82960	V	5	3-5/8	6
82970	W	5-1/8	3-3/4	6
82980	X	5-1/8	3-3/4	6
82990	Y	5-1/4	3-7/8	6
83000	Z	5-1/4	3-7/8	6

WIRE

Part #	Wire Sizes	Overall Length Inches	Flute Length Inches	Qty. per/pack
66710	1	3-7/8	2-5/8	12
57280	2	3-7/8	2-5/8	12
66700	3	3-3/4	2-1/2	12
57370	4	3-3/4	2-1/2	12
95430	5	3-3/4	2-1/2	12
66690	6	3-3/4	2-1/2	12
66680	7	3-5/8	2-7/16	12
66770	8	3-5/8	2-7/16	12
66760	9	3-5/8	2-7/16	12
92630	10	3-5/8	2-7/16	12
66670	11	3-1/2	2-5/16	12
66220	12	3-1/2	2-5/16	12
92640	13	3-1/2	2-5/16	12
66660	14	3-3/8	2-3/16	12
66650	15	3-3/8	2-3/16	12
66640	16	3-3/8	2-3/16	12
57290	17	3-3/8	2-3/16	12
66810	18	3-1/4	2-1/8	12
57550	19	3-1/4	2-1/8	12
66630	20	3-1/4	2-1/8	12
66620	21	3-1/4	2-1/8	12
57630	22	3-1/8	2	12
66610	23	3-1/8	2	12
66720	24	3-1/8	2	12
57360	25	3	1-7/8	12
66600	26	3	1-7/8	12
66750	27	3	1-7/8	12
57700	28	2-7/8	1-3/4	12
66590	29	2-7/8	1-3/4	12
95420	30	2-3/4	1-5/8	12
66800	31	2-3/4	1-5/8	12
66350	32	2-3/4	1-5/8	12
66580	33	2-5/8	1-1/2	12
66740	34	2-5/8	1-1/2	12
57350	35	2-5/8	1-1/2	12
66570	36	2-1/2	1-7/16	12
66560	37	2-1/2	1-7/16	12
66550	38	2-1/2	1-7/16	12
57560	39	2-3/8	1-3/8	12
66540	40	2-3/8	1-3/8	12

Twist Drills - HSS Black Oxide 118° NAS 907A

GENERAL PURPOSE & TITANIUM NITRIDE COATED



Type 115

Black Oxide surface finish increases wear resistance and adds lubricity to improve chip flow.



Type 100

Recommended for non-ferrous metals, wood and plastic.



Type 100-BN

Performs well in mild drilling applications with abrasive wear characteristics.

Type 115, 100, 100-BN Titanium Nitride 118° Point

- Widely used in general purpose applications
- Designed for a wide range of operating conditions and materials

FRACTIONAL

Type 115 Black Oxide Part Number	Type 100 Bright Part Number	Type 100-BN TiN Coated Part Number	Diameter Inches	Overall Length Inches	Flute Length Inches	Type 115 / Type 100 Black Oxide/Bright Qty. per/Pack	Type 100-BN TiN Coated Qty. per/Pack
01000	02750	97920	1/64	3/4	3/16	12	6
01010	02760	97910	1/32	1-3/8	1/2	12	6
01020	02770	97900	3/64	1-3/4	3/4	12	6
01030	02780	22570	1/16	1-7/8	7/8	12	6
01040	02790	22580	5/64	2	1	12	6
01050	02800	22590	3/32	2-1/4	1-1/4	12	6
01060	02810	22600	7/64	2-5/8	1-1/2	12	6
01070	02820	22610	1/8	2-3/4	1-5/8	12	6
01080	02830	22620	9/64	2-7/8	1-3/4	12	6
01090	02840	22630	5/32	3-1/8	2	12	6
01100	02850	22640	11/64	3-1/4	2-1/8	12	6
01110	02860	22650	3/16	3-1/2	2-5/16	12	6
01120	02870	22660	13/64	3-5/8	2-7/16	12	6
01130	02880	22670	7/32	3-3/4	2-1/2	12	6
01140	02890	22680	15/64	3-7/8	2-5/8	12	6
01150	02900	22690	1/4	4	2-3/4	12	6
01160	02910	22700	17/64	4-1/8	2-7/8	12	6
01170	02920	22710	9/32	4-1/4	2-15/16	12	6
01180	02930	22720	19/64	4-3/8	3-1/16	6	3
01190	02940	22730	5/16	4-1/2	3-3/16	6	3
01200	02950	22740	21/64	4-5/8	3-5/16	6	3
01210	02960	22750	11/32	4-3/4	3-7/16	6	3
01220	02970	22760	23/64	4-7/8	3-1/2	6	3
01230	02980	22770	3/8	5	3-5/8	6	3
01240	02990	22780	25/64	5-1/8	3-3/4	6	3
01250	03000	22790	13/32	5-1/4	3-7/8	6	3
01260	03010	22800	27/64	5-3/8	3-15/16	6	3
01270	03020	22810	7/16	5-1/2	4-1/16	6	3
01280	03030	22820	29/64	5-5/8	4-3/16	6	3
01290	03040	22830	15/32	5-3/4	4-5/16	6	3
01300	03050	22840	31/64	5-7/8	4-3/8	6	3
01310	03060	22850	1/2	6	4-1/2	6	3
01320	48370	32500	33/64	6-5/8	4-13/16	1	1
01330	48380	32510	17/32	6-5/8	4-13/16	1	1
01340	48390	32520	35/64	6-5/8	4-13/16	1	1
01350	48400	32530	9/16	6-5/8	4-13/16	1	1
01360	48410	32540	37/64	6-5/8	4-13/16	1	1
01370	48420	32550	19/32	7-1/8	5-3/16	1	1
01380	48430	32560	39/64	7-1/8	5-3/16	1	1
01390	48440	32570	5/8	7-1/8	5-3/16	1	1
01400	48450	32580	41/64	7-1/8	5-3/16	1	1
01410	48460	32590	21/32	7-1/8	5-3/16	1	1
01420	48470	32600	43/64	7-5/8	5-5/8	1	1
01430	48480	32610	11/16	7-5/8	5-5/8	1	1
12370	48730	32650	3/4	7-5/8	5-5/8	1	1

Letter sizes continued on page 18

Jobber Length

GENERAL PURPOSE & TITANIUM NITRIDE COATED

Type 115, 100, 100-BN Titanium Nitride 118° Point

- Widely used in general purpose applications
- Designed for a wide range of operating conditions and materials



Type 115

Black Oxide surface finish increases wear resistance and adds lubricity to improve chip flow.



Type 100

It is recommended for non-ferrous metals, wood and plastic.



Type 100-BN

Performs well in mild drilling applications with abrasive wear characteristics.

TiN

Twist Drills - General Purpose & TiN Coated

LETTER							
Type 115 Black Oxide Part Number	Type 100 Bright Part Number	Type 100-BN TiN Coated Part Number	Letter Sizes	Overall Length Inches	Flute Length Inches	Type 115 / Type 100 Black Oxide/Bright Qty. per/pack	Type 100-BN TiN Coated Qty. per/pack
02410	04160	22890	A	3-7/8	2-5/8	12	6
02420	04170	22900	B	4	2-3/4	12	6
02430	04180	22910	C	4	2-3/4	12	6
02440	04190	22920	D	4	2-3/4	12	6
02450	04200	22930	E	4	2-3/4	12	6
02460	04210	22940	F	4-1/8	2-7/8	12	6
02470	04220	22950	G	4-1/8	2-7/8	12	6
02480	04230	22960	H	4-1/8	2-7/8	12	6
02490	04240	22970	I	4-1/8	2-7/8	12	6
02500	04250	22980	J	4-1/8	2-7/8	12	6
02510	04260	22990	K	4-1/4	2-15/16	12	6
02520	04270	23000	L	4-1/4	2-15/16	12	6
02530	04280	23010	M	4-3/8	3-1/16	6	3
02540	04290	23020	N	4-3/8	3-1/16	6	3
02550	04300	23030	O	4-1/2	3-3/16	6	3
02560	04310	23040	P	4-5/8	3-5/16	6	3
02570	04320	23050	Q	4-3/4	3-7/16	6	3
02580	04330	23060	R	4-3/4	3-7/16	6	3
02590	04340	23070	S	4-7/8	3-1/2	6	3
02600	04350	23080	T	4-7/8	3-1/2	6	3
02610	04360	22790	U	5	3-5/8	6	3
02620	04370	23100	V	5	3-5/8	6	3
02630	04380	23110	W	5-1/8	3-3/4	6	3
02640	04390	23120	X	5-1/8	3-3/4	6	3
02650	04400	23130	Y	5-1/4	3-7/8	6	3
02660	04410	23140	Z	5-1/4	3-7/8	6	3

WIRE							
Type 115 Black Oxide Part Number	Type 100 Bright Part Number	Type 100-BN TiN Coated Part Number	Wire Sizes	Overall Length Inches	Flute Length Inches	Type 115 / Type 100 Black Oxide/Bright Qty. per/Pack	Type 100-BN TiN Coated Qty. per/Pack
01440	03190	47790	1	3-7/8	2-5/8	12	6
01450	03200	47800	2	3-7/8	2-5/8	12	6
01460	03210	47810	3	3-3/4	2-1/2	12	6
01470	03220	47820	4	3-3/4	2-1/2	12	6
01480	03230	47830	5	3-3/4	2-1/2	12	6
01490	03240	47840	6	3-3/4	2-1/2	12	6
01500	03250	47850	7	3-5/8	2-7/16	12	6

Wire sizes continued on page 19

GENERAL PURPOSE & TITANIUM NITRIDE COATED



Type 115

Black Oxide surface finish increases wear resistance and adds lubricity to improve chip flow.



Type 100

It is recommended for non-ferrous metals, wood and plastic.



Type 100-BN

Performs well in mild drilling applications with abrasive wear characteristics.

Type 115, 100, 100-BN Titanium Nitride 118° Point

- Widely used in general purpose applications
- Designed for a wide range of operating conditions and materials

WIRE

Type 115 Black Oxide Part Number	Type 100 Bright Part Number	Type 100-BN TiN Coated Part Number	Wire Sizes	Overall Length Inches	Flute Length Inches	Type 115 / Type 100 Black Oxide/Bright Qty. per/Pack	Type 100-BN TiN Coated Qty. per/Pack
01510	03260	47860	8	3-5/8	2-7/16	12	6
01520	03270	47870	9	3-5/8	2-7/16	12	6
01530	03280	47880	10	3-5/8	2-7/16	12	6
01540	03290	47890	11	3-1/2	2-5/16	12	6
01550	03300	47900	12	3-1/2	2-5/16	12	6
01560	03310	47910	13	3-1/2	2-5/16	12	6
01570	03320	47920	14	3-3/8	2-3/16	12	6
01580	03330	47930	15	3-3/8	2-3/16	12	6
01590	03340	47940	16	3-3/8	2-3/16	12	6
01600	03350	47950	17	3-3/8	2-3/16	12	6
01610	03360	47960	18	3-1/4	2-1/8	12	6
01620	03370	47970	19	3-1/4	2-1/8	12	6
01630	03380	47980	20	3-1/4	2-1/8	12	6
01640	03390	47990	21	3-1/4	2-1/8	12	6
01650	03400	48000	22	3-1/8	2	12	6
01660	03410	48010	23	3-1/8	2	12	6
01670	03420	48020	24	3-1/8	2	12	6
01680	03430	48030	25	3	1-7/8	12	6
01690	03440	48040	26	3	1-7/8	12	6
01700	03450	48050	27	3	1-7/8	12	6
01710	03460	48060	28	2-7/8	1-3/4	12	6
01720	03470	48070	29	2-7/8	1-3/4	12	6
01730	03480	48080	30	2-3/4	1-5/8	12	6
01740	03490	48090	31	2-3/4	1-5/8	12	6
01750	03500	48100	32	2-3/4	1-5/8	12	6
01760	03510	48110	33	2-5/8	1-1/2	12	6
01770	03520	48120	34	2-5/8	1-1/2	12	6
01780	03530	48130	35	2-5/8	1-1/2	12	6
01790	03540	48140	36	2-1/2	1-7/16	12	6
01800	03550	48150	37	2-1/2	1-7/16	12	6
01810	03560	48160	38	2-1/2	1-7/16	12	6
01820	03570	48170	39	2-3/8	1-3/8	12	6
01830	03580	48180	40	2-3/8	1-3/8	12	6
01840	03590	48190	41	2-3/8	1-3/8	12	6
01850	03600	48200	42	2-1/4	1-1/4	12	6
01860	03610	48210	43	2-1/4	1-1/4	12	6
01870	03620	48220	44	2-1/8	1-1/8	12	6
01880	03630	48230	45	2-1/8	1-1/8	12	6
01890	03640	48240	46	2-1/8	1-1/8	12	6
01900	03650	48250	47	2	1	12	6
01910	03660	48260	48	2	1	12	6
01920	03670	48270	49	2	1	12	6
01930	03680	48280	50	2	1	12	6
01940	03690	48290	51	2	1	12	6

Wire sizes continued on page 20

Jobber Length

GENERAL PURPOSE & TITANIUM NITRIDE COATED

Type 115, 100, 100-BN Titanium Nitride

118° Point

- Widely used in general purpose applications
- Designed for a wide range of operating conditions and materials



Type 115

Black Oxide surface finish increases wear resistance and adds lubricity to improve chip flow.



Type 100

It is recommended for non-ferrous metals, wood and plastic.



Type 100-BN

Performs well in mild drilling applications with abrasive wear characteristics.

WIRE

Type 115 Black Oxide Part Number	Type 100 Bright Part Number	Type 100-BN TiN Coated Part Number	Wire Sizes	Overall Length Inches	Flute Length Inches	Type 115 / Type 100 Black Oxide/Bright Qty. per/Pack	Type 100-BN TiN Coated Qty. per/Pack
01950	03700	48300	52	1-7/8	7/8	12	6
01960	03710	98000	53	1-7/8	7/8	12	6
01970	03720	97990	54	1-7/8	7/8	12	6
01980	03730	97980	55	1-7/8	7/8	12	6
01990	03740	97970	56	1-3/4	3/4	12	6
02000	03750	97960	57	1-3/4	3/4	12	6
02010	03760	97950	58	1-5/8	11/16	12	6
02020	03770	97940	59	1-5/8	11/16	12	6
02030	03780	97930	60	1-5/8	11/16	12	6
02040	03790	81200	61	1-5/8	11/16	12	----
02050	03800	81210	62	1-1/2	5/8	12	----
02060	03810	81220	63	1-1/2	5/8	12	----
02070	03820	81230	64	1-1/2	5/8	12	----
02080	03830	81240	65	1-1/2	5/8	12	----
02090	03840	81250	66	1-3/8	1/2	12	----
02100	03850	81260	67	1-3/8	1/2	12	----
02110	03860	81270	68	1-3/8	1/2	12	----
02120	03870	81280	69	1-3/8	1/2	12	----
02130	03880	81290	70	1-1/4	3/8	12	----
02140	03890	81300	71	1-1/4	3/8	12	----
02150	03900	81310	72	1-1/8	5/16	12	----
02160	03910	81320	73	1-1/8	5/16	12	----
02170	03920	81330	74	1	1/4	12	----
02180	03930	81340	75	1	1/4	12	----
02190	03940	81350	76	7/8	3/16	12	----
02200	03950	81360	77	7/8	3/16	12	----
02210	03960	81370	78	7/8	3/16	12	----
02220	03970	81380	79	3/4	1/8	12	----
02230	03980	81390	80	3/4	1/8	12	----
----	03990	----	81	3/4	1/8	12	----
----	04000	----	82	3/4	1/8	12	----
----	04010	----	83	3/4	1/8	12	----
----	04020	----	84	3/4	3/32	12	----
----	04030	----	85	3/4	3/32	12	----

Wire sizes continued on page 21

GENERAL PURPOSE & TITANIUM NITRIDE COATED



Type 115

Black Oxide surface finish increases wear resistance and adds lubricity to improve chip flow.



Type 100

It is recommended for non-ferrous metals, wood and plastic.



Type 100-BN

Performs well in mild drilling applications with strong abrasive wear characteristics.

Type 115, 100, 100-BN Titanium Nitride 118° Point

- Widely used in general purpose applications.
- Designed for a wide range of operating conditions and materials.

WIRE

Type 115 Black Oxide Part Number	Type 100 Bright Part Number	Type 100-BN TiN Coated Part Number	Wire Sizes	Overall Length Inches	Flute Length Inches	Type 115 / Type 100 Black Oxide/Bright Qty. per/Pack	Type 100-BN TiN Coated Qty. per/Pack
----	04040	----	86	3/4	3/32	12	----
----	04050	----	87	3/4	3/32	12	----
----	04060	----	88	3/4	5/64	12	----
----	04070	----	89	3/4	5/64	12	----
----	04080	----	90	3/4	5/64	12	----
----	04090	----	91	3/4	5/64	12	----
----	04100	----	92	3/4	1/16	12	----
----	04110	----	93	3/4	1/16	12	----
----	04120	----	94	3/4	1/16	12	----
----	04130	----	95	3/4	1/16	12	----
----	04140	----	96	3/4	1/16	12	----
----	04150	----	97	3/4	1/16	12	----

Type 118

V-line - General Purpose Black Oxide, 118° point

- American made value line drill
- These general purpose 118° point HSS drills are ideal for a wide variety of light tensile strength metal drilling applications.



- This series is designed for the user whose applications are well served without the need for the tighter tolerances of our standard Type 115.

Part #	Diameter Inches	Overall Length Inches	Flute Length Inches	Qty. per/pack
02783	1/16	1-7/8	7/8	12
02793	5/64	2	1	12
02803	3/32	2-1/4	1-1/4	12
02813	7/64	2-5/8	1-1/2	12
02823	1/8	2-3/4	1-5/8	12
02833	9/64	2-7/8	1-3/4	12
02843	5/32	3-1/8	2	12
02853	11/64	3-1/4	2-1/8	12
02863	3/16	3-1/2	2-5/16	12
02873	13/64	3-5/8	2-7/16	12
02883	7/32	3-3/4	2-1/2	12
02893	15/64	3-7/8	2-5/8	12
02903	1/4	4	2-3/4	12
02913	17/64	4-1/8	2-7/8	12

Part #	Diameter Inches	Overall Length Inches	Flute Length Inches	Qty. per/pack
02923	9/32	4-1/4	2-15/16	12
02933	19/64	4-3/8	3-1/16	6
02943	5/16	4-1/2	3-3/16	6
02953	21/64	4-5/8	3-5/16	6
02963	11/32	4-3/4	3-7/16	6
02973	23/64	4-7/8	3-1/2	6
02983	3/8	5	3-5/8	6
02993	25/64	5-1/8	3-3/4	6
03003	13/32	5-1/4	3-7/8	6
03013	27/64	5-3/8	3-15/16	6
03023	7/16	5-1/2	4-1/16	6
03033	29/64	5-5/8	4-3/16	6
03043	15/32	5-3/4	4-5/16	6
03053	31/64	5-7/8	4-3/8	6
03063	1/2	6	4-1/2	6

Jobber Length

GENERAL PURPOSE - BLACK OXIDE AND BRIGHT FINISH

Type 170 - METRIC

118° Point General Purpose - Black Oxide

- Widely used in general purpose applications
- Designed for a wide range of operating conditions and materials



Type 170-W - METRIC

118° Point General Purpose - Bright Finish

- This 118° point, high-speed steel drill performs well in a wide variety of drilling applications.
- It is recommended for non-ferrous metals, wood and plastics.



METRIC

Type 170 Part Number	Type 170-W Part Number	Dia. MM	Overall Length MM	Overall Length Inches	Flute Length MM	Flute Length Inches	Qty. per/pack
20630	17160	.75	35	1-3/8	13	1/2	10
20640	17070	.80	35	1-3/8	13	1/2	10
20650	17080	.85	38	1-1/2	16	5/8	10
20660	29020	.90	38	1-1/2	16	5/8	10
20670	29030	.95	38	1-1/2	16	5/8	10
20680	29040	1.00	41	1-5/8	17	11/16	10
20690	29050	1.05	41	1-5/8	17	11/16	10
20700	29060	1.10	44	1-3/4	19	3/4	10
20710	17100	1.15	44	1-3/4	19	3/4	10
20720	29070	1.20	48	1-7/8	22	7/8	10
20730	17150	1.25	48	1-7/8	22	7/8	10
20740	29080	1.30	48	1-7/8	22	7/8	10
20750	29090	1.35	48	1-7/8	22	7/8	10
20760	29100	1.40	48	1-7/8	22	7/8	10
20780	17110	1.50	48	1-7/8	22	7/8	10
20800	29110	1.60	48	1-7/8	22	7/8	10
20820	29010	1.70	51	2"	25	1	10
20830	17120	1.75	51	2"	25	1	10
20840	17130	1.80	51	2"	25	1	10
20860	29120	1.90	51	2"	25	1	10
20880	20881	2.00	51	2"	25	1	10
20980	20981	2.50	60	2-23/64	35	1-3/8	10
21040	21041	3.00	70	2-3/4	41	1-5/8	10
21110	21111	3.50	73	2-7/8	45	1-3/4	10
21170	21171	4.00	83	3-1/4	54	2-1/8	10
21230	21231	4.50	86	3-3/8	56	2-13/64	10
21290	21291	5.00	92	3-5/8	62	2-7/16	10
21350	21351	5.50	95	3-3/4	64	2-1/2	10
21410	21411	6.00	102	4"	70	2-3/4	10
21470	21471	6.50	105	4-1/8	73	2-7/8	10
21530	21531	7.00	105	4-1/8	73	2-7/8	10
21590	21591	7.50	111	4-3/8	78	3	5
21650	21651	8.00	114	4-1/2	81	3-3/16	5
21710	21711	8.50	121	4-3/4	87	3-27/64	5
21770	21771	9.00	124	4-7/8	89	3-1/2	5
21830	21831	9.50	127	5"	92	3-5/8	5
21890	21891	10.00	130	5-1/8	95	3-3/4	5
21900	21901	10.50	133	5-15/64	98	3-7/8	5
21910	21911	11.00	140	5-1/2	103	4-1/16	5
21920	21921	11.50	143	5-5/8	106	4-7/32	5
21930	21931	12.00	149	5-7/8	111	4-3/8	5
21940	21941	12.50	152	6"	114	4-1/2	5
21950	21951	13.00	152	6"	114	4-1/2	5

METRIC

Twist Drills - General Purpose Black Oxide & Bright Finish

1/4" & 3/8" REDUCED SHANK

Type 120

General Purpose 118° point - Bright Finish
1/4" Reduced Shank - Shorter than Jobber Length

- Shorter than Jobber length increases rigidity and improves drilling performance.
- Designed for use in portable air and electric drilling equipment with 1/4" chucks.



FRACTIONAL

Part #	Diameter Inches	Overall Length Inches	Flute Length Inches	Qty. per/pack
28800	17/64	3-1/2	1-7/8	12
28810	9/32	3-19/32	1-31/32	12
28820	19/64	3-23/32	2-1/16	6
28830	5/16	3-27/32	2-3/16	6
28840	21/64	4	2-9/32	6
28850	11/32	4-1/32	2-11/32	6
28860	23/64	4-5/32	2-15/32	6
28870	3/8	4-1/4	2-9/16	6
28880	25/64	4-11/32	2-5/8	6
28890	13/32	4-15/32	2-3/4	6
28900	27/64	4-9/16	2-27/32	6
28910	7/16	4-11/16	2-15/16	6
28920	29/64	4-25/32	3-1/32	6
28930	15/32	4-7/8	3-1/8	6
28940	31/64	5	3-7/32	6
28950	1/2	5	3-7/32	6

These items are also available carded.
See Price List Catalog for details.

Type 128

General Purpose 118° point - Bright Finish
3/8" Reduced Shank - Jobber Length

- General purpose 118° point HSS drill is designed for use in portable air or electric drilling equipment with 3/8" chucks.
- **NOTE:** Surface treated flutes on sizes larger than 1/2".



FRACTIONAL

Part #	Diameter Inches	Overall Length Inches	Flute Length Inches	Qty. per/pack
59570	25/64	5-1/8	3-3/4	6
59580	13/32	5-1/4	3-7/8	6
59590	27/64	5-3/8	3-15/16	6
59500	7/16	5-1/2	4-1/16	6
59600	29/64	5-5/8	4-3/16	6
59510	15/32	5-3/4	4-5/16	6
59610	31/64	5-7/8	4-3/8	6
59520	1/2	6	4-1/2	6
59530	17/32	6	4-1/4	1
59540	9/16	6	4-1/4	1
59550	19/32	6	4-1/4	1
59560	5/8	6	4-1/4	1

These items are also available carded.
See Price List Catalog for details.

Jobber Length

FAST SPIRAL HIGH HELIX

Type 240-F

Fast Spiral High Helix - 118° Point Bright Finish



- HSS drill performs well in deep hole drilling of low tensile strength material such as aluminum, zinc, copper, wood, refrigeration die castings, auto hardware & epoxy based plastics.
- Use to drill free machining steels, brass & bronze.

FRACTIONAL

Part #	Diameter Inches	Overall Length Inches	Flute Length Inches	Qty. per/pack
06550	1/32	1-3/8	1/2	12
06560	3/64	1-3/4	3/4	12
06570	1/16	1-7/8	7/8	12
06580	5/64	2	1	12
06590	3/32	2-1/4	1-1/4	12
06600	7/64	2-5/8	1-1/2	12
06610	1/8	2-3/4	1-5/8	12
06620	9/64	2-7/8	1-3/4	12
06630	5/32	3-1/8	2	12
06640	11/64	3-1/4	2-1/8	12
06650	3/16	3-1/2	2-5/16	12
06660	13/64	3-5/8	2-7/16	12
06670	7/32	3-3/4	2-1/2	12
06680	15/64	3-7/8	2-5/8	12
06690	1/4	4	2-3/4	12
06700	17/64	4-1/8	2-7/8	12
06710	9/32	4-1/4	2-15/16	12
06720	19/64	4-3/8	3-1/16	6
06730	5/16	4-1/2	3-3/16	6
06740	21/64	4-5/8	3-5/16	6
06750	11/32	4-3/4	3-7/16	6
06760	23/64	4-7/8	3-1/2	6
06770	3/8	5	3-5/8	6
06780	25/64	5-1/8	3-3/4	6
06790	13/32	5-1/4	3-7/8	6
06800	27/64	5-3/8	3-15/16	6
06810	7/16	5-1/2	4-1/16	6
06820	29/64	5-5/8	4-3/16	6
06830	15/32	5-3/4	4-5/16	6
06840	31/64	5-7/8	4-3/8	6
06850	1/2	6	4-1/2	6

WIRE

Part #	Wire Sizes	Overall Length Inches	Flute Length Inches	Qty. per/pack
06860	1	3-7/8	2-5/8	12
06870	2	3-7/8	2-5/8	12
06880	3	3-3/4	2-1/2	12
06890	4	3-3/4	2-1/2	12
06900	5	3-3/4	2-1/2	12
06910	6	3-3/4	2-1/2	12
06920	7	3-5/8	2-7/16	12
06930	8	3-5/8	2-7/16	12
06940	9	3-5/8	2-7/16	12
06950	10	3-5/8	2-7/16	12
06960	11	3-1/2	2-5/16	12
06970	12	3-1/2	2-5/16	12
06980	13	3-1/2	2-5/16	12
06990	14	3-3/8	2-3/16	12
07000	15	3-3/8	2-3/16	12
07010	16	3-3/8	2-3/16	12
07020	17	3-3/8	2-3/16	12
07030	18	3-1/4	2-1/8	12
07040	19	3-1/4	2-1/8	12
07050	20	3-1/4	2-1/8	12
07060	21	3-1/4	2-1/8	12
07070	22	3-1/8	2	12
07080	23	3-1/8	2	12
07090	24	3-1/8	2	12
07100	25	3	1-7/8	12
07110	26	3	1-7/8	12
07120	27	3	1-7/8	12
07130	28	2-7/8	1-3/4	12
07140	29	2-7/8	1-3/4	12
07150	30	2-3/4	1-5/8	12
07160	31	2-3/4	1-5/8	12
07170	32	2-3/4	1-5/8	12
07180	33	2-5/8	1-1/2	12
07190	34	2-5/8	1-1/2	12
07200	35	2-5/8	1-1/2	12
07210	36	2-1/2	1-7/16	12
07220	37	2-1/2	1-7/16	12
07230	38	2-1/2	1-7/16	12
07240	39	2-3/8	1-3/8	12
07250	40	2-3/8	1-3/8	12
07260	41	2-3/8	1-3/8	12
07270	42	2-1/4	1-1/4	12
07280	43	2-1/4	1-1/4	12
07290	44	2-1/8	1-1/8	12
07300	45	2-1/8	1-1/8	12
07310	46	2-1/8	1-1/8	12
07320	47	2	1	12
07330	48	2	1	12
07340	49	2	1	12
07350	50	2	1	12
07360	51	2	1	12
07370	52	1-7/8	7/8	12
07380	53	1-7/8	7/8	12
07390	54	1-7/8	7/8	12
07400	55	1-7/8	7/8	12
07410	56	1-3/4	3/4	12
07420	57	1-3/4	3/4	12
07430	58	1-5/8	5/8	12
07440	59	1-5/8	5/8	12
07450	60	1-5/8	5/8	12

LETTER

Part #	Letter Sizes	Overall Length Inches	Flute Length Inches	Qty. per/pack
07660	A	3-7/8	2-5/8	12
07670	B	4	2-3/4	12
07680	C	4	2-3/4	12
07690	D	4	2-3/4	12
07700	E	4	2-3/4	12
07710	F	4-1/8	2-7/8	12
07720	G	4-1/8	2-7/8	12
07730	H	4-1/8	2-7/8	12
07740	I	4-1/8	2-7/8	12
07750	J	4-1/8	2-7/8	12
07760	K	4-1/4	2-15/16	12
07770	L	4-1/4	2-15/16	12
07780	M	4-3/8	3-1/16	6
07790	N	4-3/8	3-1/16	6
07800	O	4-1/2	3-3/16	6
07810	P	4-5/8	3-5/16	6
07820	Q	4-3/4	3-7/16	6
07830	R	4-3/4	3-7/16	6
07840	S	4-7/8	3-1/2	6
07850	T	4-7/8	3-1/2	6
07860	U	5	3-5/8	6
07870	V	5	3-5/8	6
07880	W	5-1/8	3-3/4	6
07890	X	5-1/8	3-3/4	6
07900	Y	5-1/4	3-7/8	6
07910	Z	5-1/4	3-7/8	6

HEAVY-DUTY & TITANIUM NITRIDE PARABOLIC FLUTE

Type 190-P

135° Split Point - Black Oxide

- Parabolic flute drills are designed to allow deep hole drilling without frequent drill removal to clear chips.
- Parabolic flute drills perform best in low to medium tensile strength materials.



Type 190-PT

135° Split Point - Titanium Nitride Coated

- Parabolic flute drills are designed to allow deep hole drilling without frequent drill removal to clear chips.
- Exceptional high performance drill with the super hard TiN coating extends tool life 500% or more in very abrasive drilling applications.



Type 190-P Black Oxide	Type 190-PT Titanium Nitride	FRACTIONAL			Type 190-P Black Oxide	Type 190-PT Titanium Nitride
Part Number	Part Number	Diameter Inches	Overall Length Inches	Flute Length Inches	Qty. per/Pack	Qty. per/Pack
36800	37870	1/16	1-7/8	7/8	12	6
36810	37880	5/64	2	1	12	6
36820	37890	3/32	2-1/4	1-1/4	12	6
36830	37900	7/64	2-5/8	1-1/2	12	6
36840	37910	1/8	2-3/4	1-5/8	12	6
36850	37920	9/64	2-7/8	1-3/4	12	6
36860	37930	5/32	3-1/8	2	12	6
36870	37940	11/64	3-1/4	2-1/8	12	6
36880	37950	3/16	3-1/2	2-5/16	12	6
36890	37960	13/64	3-5/8	2-7/16	12	6
36900	37970	7/32	3-3/4	2-1/2	12	6
36910	37980	15/64	3-7/8	2-5/8	12	6
36920	37990	1/4	4	2-3/4	12	6
36930	38000	17/64	4-1/8	2-7/8	12	6
36940	38010	9/32	4-1/4	2-15/16	12	6
36950	38020	19/64	4-3/8	3-1/16	6	3
36960	38030	5/16	4-1/2	3-3/16	6	3
36970	38040	21/64	4-5/8	3-5/16	6	3
36980	38050	11/32	4-3/4	3-7/16	6	3
36990	38060	23/64	4-7/8	3-1/2	6	3
37000	38070	3/8	5	3-5/8	6	3
37010	38080	25/64	5-1/8	3-3/4	6	3
37020	38090	13/32	5-1/4	3-7/8	6	3
37030	38100	27/64	5-3/8	3-15/16	6	3
37040	38110	7/16	5-1/2	4-1/16	6	3
37050	38120	29/64	5-5/8	4-3/16	6	3
37060	38130	15/32	5-3/4	4-5/16	6	3
37070	38140	31/64	5-7/8	4-3/8	6	3
37080	38150	1/2	6	4-1/2	6	3
Type 190-P Black Oxide	Type 190-PT Titanium Nitride	WIRE			Type 190-P Black Oxide	Type 190-PT Titanium Nitride
Part Number	Part Number	Wire Sizes	Overall Length Inches	Flute Length Inches	Qty. per/Pack	Qty. per/Pack
68161	68162	1	3-7/8	2-5/8	12	6
68171	68172	2	3-7/8	2-5/8	12	6
38171	38172	3	3-3/4	2-1/2	12	6
68181	68182	4	3-3/4	2-1/2	12	6
68191	68192	5	3-3/4	2-1/2	12	6
68201	68202	6	3-3/4	2-1/2	12	6
58421	58422	7	3-5/8	2-7/16	12	6
68211	68212	8	3-5/8	2-7/16	12	6
68221	68222	9	3-5/8	2-7/16	12	6
68231	68232	10	3-5/8	2-7/16	12	6
68241	68242	11	3-1/2	2-5/16	12	6
68251	68252	12	3-1/2	2-5/16	12	6
68261	68262	13	3-1/2	2-5/16	12	6
68271	68272	14	3-3/8	2-3/16	12	6
68281	68282	15	3-3/8	2-3/16	12	6
68291	68292	16	3-3/8	2-3/16	12	6

Wire sizes continued on page 26

Jobber Length

HEAVY-DUTY & TITANIUM NITRIDE PARABOLIC FLUTE

Type 190-P

135° Split Point - Black Oxide



Type 190-PT

135° Split Point - Titanium Nitride Coated



TiN

Twist Drills - Parabolic & TiN Coated Parabolic Flutes

Type 190-P Black Oxide	Type 190-PT Titanium Nitride	WIRE			Type 190-P Black Oxide	Type 190-PT Titanium Nitride
Part Number	Part Number	Wire Sizes	Overall Length Inches	Flute Length Inches	Qty. per/Pack	Qty. per/Pack
68301	68302	17	3-3/8	2-3/16	12	6
58591	58592	18	3-1/4	2-1/8	12	6
68311	68312	19	3-1/4	2-1/8	12	6
58381	58382	20	3-1/4	2-1/8	12	6
58721	58722	21	3-1/4	2-1/8	12	6
68321	68322	22	3-1/8	2	12	6
68331	68332	23	3-1/8	2	12	6
68341	68342	24	3-1/8	2	12	6
58901	58902	25	3	1-7/8	12	6
68351	68352	26	3	1-7/8	12	6
68361	68362	27	3	1-7/8	12	6
68371	68372	28	2-7/8	1-3/4	12	6
37321	37322	29	2-7/8	1-3/4	12	6
68381	68382	30	2-3/4	1-5/8	12	6
68391	68392	31	2-3/4	1-5/8	12	6
68401	68402	32	2-3/4	1-5/8	12	6
58441	58442	33	2-5/8	1-1/2	12	6
68411	68412	34	2-5/8	1-1/2	12	6
68421	68422	35	2-5/8	1-1/2	12	6
58581	58582	36	2-1/2	1-7/16	12	6
37721	37722	37	2-1/2	1-7/16	12	6
68431	68432	38	2-1/2	1-7/16	12	6
58451	58452	39	2-3/8	1-3/8	12	6
38321	38322	40	2-3/8	1-3/8	12	6
Type 190-P Black Oxide	Type 190-PT Titanium Nitride	LETTER			Type 190-P Black Oxide	Type 190-PT Titanium Nitride
Part Number	Part Number	Letter Sizes	Overall Length Inches	Flute Length Inches	Qty. per/Pack	Qty. per/Pack
70880	58372	A	3-7/8	2-5/8	12	6
70890	58402	B	4	2-3/4	12	6
70900	58412	C	4	2-3/4	12	6
70910	58462	D	4	2-3/4	12	6
71950	58472	E	4	2-3/4	12	6
58481	58482	F	4-1/8	2-7/8	12	6
70920	58492	G	4-1/8	2-7/8	12	6
70930	58512	H	4-1/8	2-7/8	12	6
70940	58532	I	4-1/8	2-7/8	12	6
70950	58542	J	4-1/8	2-7/8	12	6
71960	58552	K	4-1/4	2-15/16	12	6
70960	58562	L	4-1/4	2-15/16	12	6
70970	58572	M	4-3/8	3-1/16	6	3
70980	58602	N	4-3/8	3-1/16	6	3
70990	58612	O	4-1/2	3-3/16	6	3
71000	58622	P	4-5/8	3-5/16	6	3
71010	58632	Q	4-3/4	3-7/16	6	3
71020	58642	R	4-3/4	3-7/16	6	3
71030	58652	S	4-7/8	3-1/2	6	3
71040	58662	T	4-7/8	3-1/2	6	3
71050	58672	U	5	3-5/8	6	3
71060	58732	V	5	3-5/8	6	3
71070	58682	W	5-1/8	3-3/4	6	3
72000	58692	X	5-1/8	3-3/4	6	3
71080	58702	Y	5-1/4	3-7/8	6	3
71090	58712	Z	5-1/4	3-7/8	6	3

AUTOMOTIVE SERIES TANGED DRIVE

Type 230

Automotive Series Tanged Drive
118° Point General Purpose - Black Oxide

• Tang drive used with A.S.A. split sleeve drill drivers



FRACTIONAL

Part #	Diameter Inches	Overall Length Inches	Flute Length Inches	Qty. per/pack
13300	1/8	2-3/4	1-5/8	12
13360	9/64	2-7/8	1-3/4	12
13400	5/32	3-1/8	2	12
13440	11/64	3-1/4	2-1/8	12
13490	3/16	3-1/2	2-5/16	12
13540	13/64	3-5/8	2-7/16	12
13570	7/32	3-3/4	2-1/2	12
13600	15/64	3-7/8	2-5/8	12
13630	1/4	4	2-3/4	12
13670	17/64	4-1/8	2-7/8	12
13700	9/32	4-1/4	2-15/16	12
13730	19/64	4-3/8	3-1/16	6
13760	5/16	4-1/2	3-3/16	6
13790	21/64	4-5/8	3-5/16	6
13820	11/32	4-3/4	3-7/16	6
13850	23/64	4-7/8	3-1/2	6
13870	3/8	5	3-5/8	6
13890	25/64	5-1/8	3-3/4	6
13910	13/32	5-1/4	3-7/8	6
13920	27/64	5-3/8	3-15/16	6
13930	7/16	5-1/2	4-1/16	6
13940	29/64	5-5/8	4-3/16	6
13950	15/32	5-3/4	4-5/16	6
13960	31/64	5-7/8	4-3/8	6
13970	1/2	6	4-1/2	6
13980	33/64	6-5/8	4-13/16	1
13990	17/32	6-5/8	4-13/16	1
14000	35/64	6-5/8	4-13/16	1
14010	9/16	6-5/8	4-13/16	1
14020	37/64	6-5/8	4-13/16	1
14030	19/32	7-1/8	5-3/16	1
14040	39/64	7-1/8	5-3/16	1
14050	5/8	7-1/8	5-3/16	1
14060	41/64	7-1/8	5-3/16	1
14070	21/32	7-1/8	5-3/16	1
14080	43/64	7-5/8	5-5/8	1
14090	11/16	7-5/8	5-5/8	1

Twist Drills - Automotive Series Tanged Drive

Mechanic Length

HSS MAGNUM

Type 175-AG

Magnum Super Premium 3-Flats on Shank - 135° Split Point

- Special Hi-Molybdenum tool steel.
- 135° split point for fast penetration and accurate starting without center punch.
- Precision ground point, flutes, body, clearance and drill diameter for the ultimate in accuracy and performance.
- Body and clearance are gold surface treated for maximum lubricity.
- Flats on shank give positive chuck-grip (3/16" and Larger).



3 - FLATS ON SHANK

Part #	Diameter Inches	Overall Length Inches	Flute Length Inches	Qty. per/pack
22860	1/16	1-7/8	7/8	12
22870	5/64	2	1	12
22880	3/32	2-1/4	1-1/4	12
86950	7/64	2-3/8	1-5/16	12
86960	1/8	2-1/2	1-7/16	12
86970	9/64	2-5/8	1-9/16	12
86980	5/32	2-3/4	1-11/16	12
86990	11/64	2-7/8	1-13/16	12
87000	3/16	3	1-7/8	12
87010	13/64	3-1/8	1-15/16	12
87020	7/32	3-1/4	2	12
87030	15/64	3-3/8	2-1/16	12
87040	1/4	3-1/2	2	12
87050	17/64	3-5/8	2-1/8	12
87060	9/32	3-3/4	2-1/4	12
87070	19/64	3-7/8	2-3/8	6
87080	5/16	4	2-1/2	6
87090	21/64	4-1/16	2-9/16	6
87100	11/32	4-1/8	2-5/8	6
87110	23/64	4-3/16	2-11/16	6
87120	3/8	4-1/4	2-11/16	6
87130	25/64	4-5/16	2-3/4	6
87140	13/32	4-3/8	2-13/16	6
87150	27/64	4-7/16	2-7/8	6
87160	7/16	4-1/2	2-15/16	6
87170	29/64	4-5/8	3	6
87180	15/32	4-3/4	3-1/8	6
87190	31/64	4-7/8	3-1/4	6
87200	1/2	5	3-3/8	6

These items are also available carded.
See Price List Catalog for details.

Type 178-AG

Magnum Super Premium - 135° Split Point 3-Flats on Shank - 3/8" Reduced Shank

- Reduced shank with flats for positive chuck grip.



3 - FLATS ON SHANK - 3/8" SHANK

Part #	Diameter Inches	Overall Length Inches	Flute Length Inches	Qty. per/pack
81560	13/32	4-3/8	2-13/16	6
81570	27/64	4-7/16	2-7/8	6
81580	7/16	4-1/2	2-15/16	6
81590	29/64	4-5/8	3	6
81600	15/32	4-3/4	3-1/8	6
81610	31/64	4-7/8	3-1/4	6
81620	1/2	5	3-3/8	6

25/64" 175-AG drills with flats will fit a 3/8" chuck without reducing the shank diameter

These items are also available carded. See Price List Catalog for details.

Type 191

V-line, CAD-HD Series - Black Oxide 135° Split Point

- American made value line drill
- New advances in drill making technology have allowed us to make an excellent drill for the very price sensitive portions of the business.
- The black surface treatment prevents chip welding and increases abrasion resistance.



Part #	Diameter Inches	Overall Length Inches	Flute Length Inches	Qty. per/pack
04492	1/16	1-7/8	7/8	12
04502	5/64	2	1	12
04512	3/32	2-1/4	1-1/4	12
04522	7/64	2-3/8	1-1/4	12
04532	1/8	2-1/2	1-5/16	12
04542	9/64	2-5/8	1-3/8	12
04552	5/32	2-3/4	1-7/16	12
04562	11/64	2-7/8	1-1/2	12
04572	3/16	2	1-9/16	12
04582	13/64	3-1/8	1-5/8	12
04592	7/32	3-1/4	1-11/16	12
04602	15/64	3-3/8	1-3/4	12
04612	1/4	3-1/2	1-13/16	12
04622	17/64	3-5/8	1-7/8	12
04632	9/32	3-3/4	1-15/16	12
04642	19/64	3-7/8	2"	6
04652	5/16	4	2-1/16	6
04662	21/64	4-1/16	2-1/8	6
04672	11/32	4-1/8	2-3/16	6
04682	23/64	4-3/16	2-3/16	6
04692	3/8	4-1/4	2-3/16	6
04702	25/64	4-5/16	2-1/4	6
04712	13/32	4-3/8	2-1/4	6
04722	27/64	4-7/16	2-5/16	6
04732	7/16	4-1/2	2-5/16	6
04742	29/64	4-5/8	2-3/8	6
04752	15/32	4-3/4	2-7/16	6
04762	31/64	4-7/8	2-1/2	6
04772	1/2	5	2-9/16	6

HEX SHANK - 1/4" QUICK RELEASE

Type QR-AG Magnum Super Premium Quick Release Drills - 135° Split Point



- A mechanic length with a quick release shank
 - Special Hi-Molybdenum tool steel.
- 135° split point for fast penetration and accurate starting without center punch.
- Body and clearance are gold treated for maximum lubricity.
- Specially designed for hand held drill and impact tools.
 - Recommended use in work hardening grades of stain-less steel and other hard metal drill applications.

QR-AG 1/4" HEX SHANK

Part #	Diameter Inches	Overall Length Inches	Flute Length Inches	Qty. per/pack
34501	1/16	2-5/8	7/8	6
34521	3/32	3	1-1/4	6
34541	1/8	3-1/4	1-7/16	6
34561	5/32	3-1/2	1-11/16	6
34581	3/16	3-3/4	1-7/8	6
34611	7/32	4"	2"	6
34631	1/4	4-1/4	2"	6
34651	9/32	3-13/16	2-1/4	6
34671	5/16	4"	2-1/2	3
34691	11/32	4-7/32	2-5/8	3
34711	3/8	4-1/4	2-11/16	3
34731	13/32	4-1/2	2-13/16	3
34751	7/16	4-1/2	2-15/16	3
34771	15/32	4-7/8	3-1/8	3
34791	1/2	5"	3-3/8	3
34801	Quick Release Adapter			

CARDED QR-AG 1/4" HEX SHANK

Part #	Diameter Inches	Overall Length Inches	Flute Length Inches	Qty. per/pack
34507	1/16	2-5/8	7/8	2
34527	3/32	3	1-1/4	2
34547	1/8	3-1/4	1-7/16	2
34567	5/32	3-1/2	1-11/16	2
34587	3/16	3-3/4	1-7/8	2
34617	7/32	4"	2"	1
34637	1/4	4-1/4	2"	1
34657	9/32	3-13/16	2-1/4	1
34677	5/16	4"	2-1/2	1
34697	11/32	4-7/32	2-5/8	1
34717	3/8	4-1/4	2-11/16	1
34737	13/32	4-1/2	2-13/16	1
34757	7/16	4-1/2	2-15/16	1
34777	15/32	4-7/8	3-1/8	1
34797	1/2	5"	3-3/8	1
34807	Quick Release Adapter (CARDED)			

TYPE QR-AG EXTENSIONS

- One handed operation – Simply push your PTA into the extension and it will automatically load and lock the accessory.
- Patented All Hex connection system will hold any 1/4" hex shape including, Power Groove and Notched product.
- Patented All Hex connection system holds the accessory without any wobble or play. Tight fit for a professional feel.
- Made in the USA.
- **Not** intended for Impact Tools.



Part No.	Size	Qty. per/pack
34821	3" Quick release Extension	1
34831	6" Quick release Extension	1
34841	12" Quick release Extension	1

SETS HEX SHANK - 1/4" QUICK RELEASE



QR-12 SET HARD CASE - INDEX

Part #	Description of Sizes	Qty of each
34811	1/16, 3/32, 1/8, 5/32, 3/16, 7/32, 1/4, 5/16, 3/8, 7/16, 1/2" & Quick Release Adapter	1



QR-16 SET SOFT POUCH - INDEX

Part #	Description of Sizes	Qty of each
34812	1/16, 3/32, 1/8, 5/32, 3/16, 7/32, 1/4, 9/32, 5/16, 11/32, 3/8" 13/32, 7/16, 15/32, 1/2" & Quick Release Adapter	1

QR-7A - SOFT POUCH INDEX

Part #	Description of Sizes	Qty of each
34803	1/16, 3/32, 1/8, 5/32, 3/16, 7/32, 1/4"	1

QR-7B SET SOFT POUCH - INDEX

Part #	Description of Sizes	Qty of each
34804	1/8, 3/16, 1/4, 5/16, 3/8, 7/16, 1/2"	1

Jobber Length

M42 COBALT-TITANIUM NITRIDE & TITANIUM ALUMINUM NITRIDE NAS 907J

Type 150 - M42 Cobalt, Type 150-N - TiN Coated
Type 150-ALN - Titanium Aluminum Nitride

135° Split Point - M42 Cobalt NAS 907J

- Manufactured from M42 HSS containing 8% cobalt which increases high red hardness.
- Cobalt drills require rigidly held positive feed drilling equipment.
- Titanium Aluminum Nitride can be used in machining stainless steel, nickel based and titanium alloys, not recommended for aluminum.
- Manufactured to NAS 907J specifications.



Type 150

Use to drill hard, tough metals, free machining stainless steel, titanium alloys and certain abrasive plastics.



Type 150-N

Titanium nitride coating for lubricity, and extended tool life.



Type 150-ALN

Titanium aluminum nitride designed for use where extreme temperatures are found, allows for increased machining speeds up to 200%.

FRACTIONAL

150 Part#	150-N Part#	150-ALN Part#	Overall Diameter Inches	Flute Length Inches	Length Inches	150 Qty. per/Pk	150-N/150-ALN Qty. per/Pk
08000	-----	-----	3/64	1-3/4	3/4	12	6
08010	79600	80003	1/16	1-7/8	7/8	12	6
08020	79610	80013	5/64"	2"	1"	12	6
08030	79620	80023	3/32	2-1/4	1-1/4	12	6
08040	79630	80033	7/64	2-5/8	1-1/2	12	6
08050	79640	80043	1/8"	2-3/4"	1-5/8"	12	6
08060	79650	80053	9/64	2-7/8	1-3/4	12	6
08070	79660	80063	5/32"	3-1/8"	2"	12	6
08080	79670	80073	11/64	3-1/4	2-1/8	12	6
08090	79680	80083	3/16	3-1/2	2-5/16	12	6
08100	79690	80093	13/64	3-5/8	2-7/16	12	6
08110	79700	80103	7/32	3-3/4	2-1/2	12	6
08120	79710	80113	15/64	3-7/8	2-5/8	12	6
08130	79720	80123	1/4"	4"	2-3/4"	12	6
08140	79730	80133	17/64	4-1/8	2-7/8	12	6
08150	79740	80143	9/32	4-1/4	2-15/16	12	6
08160	79750	80153	19/64	4-3/8	3-1/16	6	3
08170	79760	80163	5/16	4-1/2	3-3/16	6	3
08180	79770	80173	21/64	4-5/8	3-5/16	6	3
08190	79780	80183	11/32	4-3/4	3-7/16	6	3
08200	79790	80193	23/64	4-7/8	3-1/2	6	3
08210	79800	80203	3/8"	5"	3-5/8"	6	3
08220	79810	80213	25/64	5-1/8	3-3/4	6	3
08230	79820	80223	13/32	5-1/4	3-7/8	6	3
08240	79830	80233	27/64	5-3/8	3-15/16	6	3
08250	79840	80243	7/16	5-1/2	4-1/16	6	3
08260	79850	80253	29/64	5-5/8	4-3/16	6	3
08270	79860	80263	15/32	5-3/4	4-5/16	6	3
08280	79870	80273	31/64	5-7/8	4-3/8	6	3
08290	79880	80283	1/2"	6"	4-1/2"	6	3

150 Part#	150-N Part#	150-ALN Part#	Wire Sizes	Overall Diameter Inches	Flute Length Inches	150 Qty. per/Pk	150-N/150-ALN Qty. per/Pk
08370	77071	80623	8	3-5/8	2-7/16	12	6
08380	77081	80633	9	3-5/8	2-7/16	12	6
08390	77091	80643	10	3-5/8	2-7/16	12	6
08400	77101	80653	11	3-1/2	2-5/16	12	6
08410	77111	80663	12	3-1/2	2-5/16	12	6
08420	77121	80673	13	3-1/2	2-5/16	12	6
08430	77131	80683	14	3-3/8	2-3/16	12	6
08440	77141	80693	15	3-3/8	2-3/16	12	6
08450	77151	80703	16	3-3/8	2-3/16	12	6
08460	77161	80713	17	3-3/8	2-3/16	12	6
08470	77171	80723	18	3-1/4	2-1/8	12	6
08480	77181	80733	19	3-1/4	2-1/8	12	6
08490	77191	80743	20	3-1/4	2-1/8	12	6
08500	77201	80753	21	3-1/4	2-1/8	12	6
08510	77211	80763	22	3-1/8	2"	12	6
08520	77221	80773	23	3-1/8	2"	12	6
08530	77231	80783	24	3-1/8	2"	12	6
08540	77241	80793	25	3"	1-7/8	12	6
08550	77251	80803	26	3"	1-7/8	12	6
08560	77261	80813	27	3"	1-7/8	12	6
08570	77271	80823	28	2-7/8	1-3/4	12	6
08580	77281	80833	29	2-7/8	1-3/4	12	6
08590	77291	80843	30	2-3/4	1-5/8	12	6
08600	77301	80853	31	2-3/4	1-5/8	12	6
08610	77311	80863	32	2-3/4	1-5/8	12	6
08620	77321	80873	33	2-5/8	1-1/2	12	6
08630	77331	80883	34	2-5/8	1-1/2	12	6
08640	77341	80893	35	2-5/8	1-1/2	12	6
08650	77351	80903	36	2-1/2	1-7/16	12	6
08660	77361	80913	37	2-1/2	1-7/16	12	6
08670	77371	80923	38	2-1/2	1-7/16	12	6
08680	77381	80933	39	2-3/8	1-3/8	12	6
08690	77491	80943	40	2-3/8	1-3/8	12	6
08700	77401	80953	41	2-3/8	1-3/8	12	6
08710	77411	80963	42	2-1/4	1-1/4	12	6
08720	77421	80973	43	2-1/4	1-1/4	12	6
08730	77431	80983	44	2-1/8	1-1/8	12	6
08740	77441	80993	45	2-1/8	1-1/8	12	6
08750	77451	81003	46	2-1/8	1-1/8	12	6
08760	77461	81013	47	2"	1"	12	6
08770	77471	81023	48	2"	1"	12	6
08780	77481	81033	49	2"	1"	12	6
08790	77491	81043	50	2"	1"	12	6
08800	77501	81053	51	2"	1"	12	6
08810	77511	81063	52	1-7/8	7/8	12	6
08820	77521	81073	53	1-7/8	7/8	12	6
08830	77531	81083	54	1-7/8	7/8	12	6
08840	77541	81093	55	1-7/8	7/8	12	6
08850	77551	81103	56	1-3/4	3/4	12	6
08860	77561	81113	57	1-3/4	3/4	12	6
08870	77571	81123	58	1-5/8	11/16	12	6
08880	77581	81133	59	1-5/8	11/16	12	6
08890	77591	81143	60	1-5/8	11/16	12	6
08900	-----	-----	61	1-5/8	11/16	12	6
08910	-----	-----	62	1-1/2	5/8	12	6
08921	-----	-----	63	1-1/2	5/8	12	6
08931	-----	-----	64	1-1/2	5/8	12	6
08941	-----	-----	65	1-1/2	5/8	12	6
08951	-----	-----	66	1-3/8	1/2	12	6
08961	-----	-----	67	1-3/8	1/2	12	6
08971	-----	-----	68	1-3/8	1/2	12	6
08981	-----	-----	69	1-3/8	1/2	12	6
08991	-----	-----	70	1-1/4	3/8	12	6
09001	-----	-----	71	1-1/4	3/8	12	6
09011	-----	-----	72	1-1/8	5/16	12	6
09021	-----	-----	73	1-1/8	5/16	12	6
09031	-----	-----	74	1"	1/4	12	6
09041	-----	-----	75	1"	1/4	12	6
09051	-----	-----	76	7/8	3/16	12	6
09061	-----	-----	77	7/8	3/16	12	6
09071	-----	-----	78	7/8	3/16	12	6
09081	-----	-----	79	3/4	3/16	12	6
09091	-----	-----	80	3/4	3/16	12	6

LETTER

150 Part#	150-N Part#	150-ALN Part#	Letter Sizes	Overall Length Inches	Flute Length Inches	150 Qty. per/Pk	150-N/150-ALN Qty. per/Pk
08940	79320	80293	A	3-7/8	2-5/8	12	6
08950	79330	80303	B	4"	2-3/4	12	6
08960	79340	80313	C	4"	2-3/4	12	6
08970	79350	80323	D	4"	2-3/4	12	6
08980	79360	80333	E	4"	2-3/4	12	6
08990	79370	80343	F	4-1/8	2-7/8	12	6
09000	79380	80353	G	4-1/8	2-7/8	12	6
09010	79390	80363	H	4-1/8	2-7/8	12	6
09020	79400	80373	I	4-1/8	2-7/8	12	6
09030	79410	80383	J	4-1/8	2-7/8	12	6
09040	79420	80393	K	4-1/4	2-15/16	12	6
09050	79430	80403	L	4-1/4	2-15/16	12	6
09060	79440	80413	M	4-3/8	3-3/16	6	3
09070	79450	80423	N	4-3/8	3-1/16	6	3
09080	79460	80433	O	4-1/2	3-3/16	6	3
09090	79470	80443	P	4-5/8	3-5/16	6	3
09100	79480	80453	Q	4-3/4	3-7/16	6	3
09110	79490	80463	R	4-3/4	3-7/16	6	3
09120	79500	80473	S	4-7/8	3-1/2	6	3
09130	79510	80483	T	4-7/8	3-1/2	6	3
09140	79520	80493	U	5"	3-5/8	6	3
09150	79530	80503	V	5"	3-5/8	6	3
09160	79540	80513	W	5-1/8	3-3/4	6	3
09170	79550	80523	X	5-1/8	3-3/4	6	3
09180	79560	80533	Y	5-1/4	3-7/8	6	3
09190	79570	80543	Z	5-1/4	3-7/8	6	3

WIRE

150 Part#	150-N Part#	150-ALN Part#	Wire Sizes	Overall Diameter Inches	Flute Length Inches	150 Qty. per/Pk	150N/150ALN Qty. per/Pk
08300	77001	80553	1	3-7/8	2-5/8	12	6
08310	77011	80563	2	3-7/8	2-5/5	12	6
08320	77021	80573	3	3-3/4	2-1/2	12	6
08330	77031	80583	4	3-3/4	2-1/2	12	6
08340	77041	80593	5	3-3/4	2-1/2	12	6
08350	77051	80603	6	3-3/4	2-1/2	12	6
08360	77061	80613	7	3-5/8	2-7/16	12	6

Wire sizes continued next Column

TiAIN

TiN

Twist Drills - M42 Cobalt Titanium Nitride/Titanium Aluminum Nitride NAS 907-J

Jobber Length

M42 COBALT NAS 907J

Type 150-M

METRIC - Jobber Length 135° Split Point
M42 Cobalt - NAS 907J



- Manufactured from M42 HSS containing 8% cobalt which increases high hot hardness.
- Cobalt drills require rigidly held positive feed drilling equipment.
- Manufactured to **NAS 907J** specifications.

METRIC

Part #	Diameter		Overall Length		Flute Length		Qty. per/pack	Part #	Diameter		Overall Length		Flute Length		Qty. per/pack
	MM	Inches	MM	Inches	MM	Inches			MM	Inches	MM	Inches	MM	Inches	
27050	0.90	38	1-1/2	16	5/8	10	34130	6.80	105	4-1/8	73	2-7/8	10		
27060	0.95	38	1-1/2	16	5/8	10	34140	6.90	105	4-1/8	73	2-7/8	10		
27070	1.00	41	1-5/8	17	11/16	10	34150	7.00	105	4-1/8	73	2-7/8	10		
27080	1.05	41	1-5/8	17	11/16	10	34160	7.10	108	4-1/4	75	2-61/64	10		
27090	1.10	44	1-3/4	19	3/4	10	34170	7.20	108	4-1/4	75	2-61/64	10		
27100	1.20	48	1-7/8	22	7/8	10	34180	7.30	108	4-1/4	75	2-61/64	10		
27110	1.30	48	1-7/8	22	7/8	10	34190	7.40	111	4-3/8	78	3	10		
08831	1.40	48	1-7/8	22	7/8	10	34200	7.50	111	4-3/8	78	3	5		
27130	1.50	48	1-7/8	22	7/8	10	34210	7.60	111	4-3/8	78	3	5		
27140	1.60	48	1-7/8	22	7/8	10	34220	7.70	114	4-1/2	81	3-3/16	5		
27150	1.70	51	2"	25	1	10	34230	7.80	114	4-1/2	81	3-3/16	5		
27160	1.80	51	2"	25	1	10	34240	7.90	114	4-1/2	81	3-3/16	5		
27170	1.90	51	2"	25	1	10	34250	8.00	114	4-1/2	81	3-3/16	5		
26460	2.00	51	2"	25	1	10	34260	8.10	117	4-9/16	84	3-5/16	5		
26940	2.05	54	2-1/8	25	1-5/32	10	34270	8.20	117	4-9/16	84	3-5/16	5		
26470	2.10	54	2-1/8	29	1-5/32	10	34280	8.30	117	4-9/16	84	3-5/16	5		
26480	2.20	57	2-1/4	32	1-1/4	10	34290	8.40	121	4-3/4	87	3-27/64	5		
26490	2.30	57	2-1/4	32	1-1/4	10	34300	8.50	121	4-3/4	87	3-27/64	5		
26500	2.40	60	2-23/64	35	1-3/8	10	34310	8.60	121	4-3/4	87	3-27/64	5		
26510	2.50	60	2-23/64	35	1-3/8	10	34320	8.70	121	4-3/4	87	3-27/64	5		
26520	2.60	64	2-1/2	37	1-29/64	10	34330	8.80	124	4-7/8	89	3-1/2	5		
26530	2.70	64	2-1/2	37	1-15/32	10	34340	8.90	124	4-7/8	89	3-1/2	5		
26540	2.80	67	2-5/8	38	1-1/2	10	34350	9.00	124	4-7/8	89	3-1/2	5		
26550	2.90	70	2-3/4	41	1-5/8	10	34360	9.10	124	4-7/8	89	3-1/2	5		
26560	3.00	70	2-3/4	41	1-5/8	10	34370	9.20	127	5"	92	3-5/8	5		
26570	3.10	70	2-3/4	41	1-5/8	10	34380	9.30	127	5"	92	3-5/8	5		
26580	3.20	70	2-3/4	41	1-5/8	10	34390	9.40	127	5"	92	3-5/8	5		
26590	3.30	73	2-7/8	45	1-3/4	10	34400	9.50	127	5"	92	3-5/8	5		
26600	3.40	73	2-7/8	45	1-3/4	10	34410	9.60	130	5-1/8	95	3-3/4	5		
26610	3.50	73	2-7/8	45	1-3/4	10	34420	9.70	130	5-1/8	95	3-3/4	5		
26620	3.60	76	3"	48	1-7/8	10	34430	9.80	130	5-1/8	95	3-3/4	5		
26630	3.70	76	3"	48	1-7/8	10	34440	9.90	130	5-1/8	95	3-3/4	5		
26640	3.80	76	3"	48	1-7/8	10	34450	10.00	130	5-1/8	95	3-3/4	5		
26650	3.90	79	3-1/8	51	2	10	34452	10.10	133	5-15/64	98	3-7/8	5		
26660	4.00	83	3-1/4	54	2-1/8	10	34460	10.20	133	5-15/64	98	3-7/8	5		
26670	4.10	83	3-1/4	54	2-1/8	10	34461	10.30	133	5-15/64	98	3-7/8	5		
26680	4.20	83	3-1/4	54	2-1/8	10	34462	10.40	133	5-1/4	98	3-7/8	5		
26690	4.30	83	3-1/4	54	2-1/8	10	34470	10.50	133	5-15/64	98	3-7/8	5		
34570	4.40	86	3-3/8	56	2-13/64	10	34472	10.60	136	5-3/8	100	3-15/16	5		
26700	4.50	86	3-3/8	56	2-13/64	10	34512	10.70	136	5-3/8	100	3-15/16	5		
26710	4.60	86	3-3/8	56	2-13/64	10	34480	10.80	140	5-1/2	103	4-1/16	5		
26720	4.70	89	3-1/2	59	2-21/64	10	34482	10.90	140	5-1/2	103	4-1/16	5		
26730	4.80	89	3-1/2	59	2-21/64	10	34490	11.00	140	5-1/2	103	4-1/16	5		
26740	4.90	92	3-5/8	62	2-7/16	10	34492	11.10	140	5-1/2	103	4-1/16	5		
26750	5.00	92	3-5/8	62	2-7/16	10	34502	11.30	143	5-5/8	106	4-7/32	5		
33960	5.10	92	3-5/8	62	2-7/16	10	34500	11.20	143	5-5/8	106	4-7/32	5		
33970	5.20	95	3-3/4	64	2-1/2	10	34504	11.40	143	5-5/8	106	4-7/32	5		
33980	5.30	95	3-3/4	64	2-1/2	10	34510	11.50	143	5-5/8	106	4-7/32	5		
33990	5.40	95	3-3/4	64	2-1/2	10	34514	11.60	146	5-3/4	110	4-11/32	5		
34000	5.50	95	3-3/4	64	2-1/2	10	34519	11.70	146	5-3/4	110	4-11/32	5		
34010	5.60	98	3-7/8	67	2-5/8	10	34520	11.80	146	5-3/4	110	4-11/32	5		
34020	5.70	98	3-7/8	67	2-5/8	10	34522	11.90	146	5-3/4	109	4-5/16	5		
34030	5.80	98	3-7/8	67	2-5/8	10	34530	12.00	149	5-7/8	111	4-3/8	5		
34040	5.90	98	3-7/8	67	2-5/8	10	34532	12.10	149	5-7/8	111	4-3/8	5		
34050	6.00	102	4"	70	2-3/4	10	34540	12.20	149	5-7/8	111	4-3/8	5		
34060	6.10	102	4"	70	2-3/4	10	34542	12.30	149	5-7/8	111	4-3/8	5		
34070	6.20	102	4"	70	2-3/4	10	34544	12.40	152	6"	114	4-1/2	5		
34080	6.30	102	4"	70	2-3/4	10	34550	12.50	152	6"	114	4-1/2	5		
34090	6.40	105	4-1/8	73	2-7/8	10	34552	12.60	152	6"	114	4-1/2	5		
34100	6.50	105	4-1/8	73	2-7/8	10	34580	12.70	152	6"	114	4-1/2	5		
34110	6.60	105	4-1/8	73	2-7/8	10	34590	12.80	152	6"	114	4-1/2	5		
34120	6.70	105	4-1/8	73	2-7/8	10	34980	12.90	152	6"	114	4-1/2	5		
							34560	13.00	152	6"	114	4-1/2	5		

METRIC

Twist Drills - M42 Cobalt NAS 907J

DIN Length

HSS M42 COBALT DIN 338

Type XGT-J - METRIC

DIN 338 Length - 135° Split Point
M-42 Cobalt High Speed Steel

- Gyroidal Torsion flute and wide land construction yields exceptional performance in deep hole drilling.
- Recommended for a wide range of steels, castings and other hard metal drilling applications.
- Cobalt steel is abrasion and heat resistant.
- Allows deep hole drilling without drill retraction.



Type XGT-J
Heavy duty wide land parabolic.

METRIC

Part #	Dia. MM	Frac/ Wire/ Letter	Overall Length		Flute Length		Qty. per/pack
			MM	Inches	MM	Inches	
00200	1.00		41	1 5/8	17	11/16	10
00201	1.02	60	41	1 5/8	17	11/16	10
00202	1.04	59	41	1 5/8	17	11/16	10
00203	1.05		41	1 5/8	17	11/16	10
00204	1.07	58	41	1 5/8	17	11/16	10
00210	1.09	57	44	1 3/4	19	3/4	10
00211	1.10		44	1 3/4	19	3/4	10
00212	1.15		44	1 3/4	19	3/4	10
00213	1.18	56	44	1 3/4	19	3/4	10
00214	1.19	3/64	44	1 3/4	19	3/4	10
00220	1.20		48	1 7/8	22	7/8	10
00221	1.25		48	1 7/8	22	7/8	10
00222	1.30		48	1 7/8	22	7/8	10
00223	1.32	55	48	1 7/8	22	7/8	10
00224	1.35		48	1 7/8	22	7/8	10
00230	1.40	54	48	1 7/8	22	7/8	10
00232	1.45		48	1 7/8	22	7/8	10
00233	1.50		48	1 7/8	22	7/8	10
00234	1.51	53	48	1 7/8	22	7/8	10
00240	1.55		48	1 7/8	22	7/8	10
00241	1.59	1/16	48	1 7/8	22	7/8	10
00242	1.60		48	1 7/8	22	7/8	10
00243	1.61	52	48	1 7/8	22	7/8	10
00244	1.65		51	2	25	1	10
00250	1.70	51	51	2	25	1	10
00252	1.75		51	2	25	1	10
00253	1.78	50	51	2	25	1	10
00254	1.80		51	2	25	1	10
00260	1.85	49	51	2	25	1	10
00262	1.90		51	2	25	1	10
00263	1.93	48	51	2	25	1	10
00264	1.95		51	2	25	1	10
00270	1.98	5/64	51	2	25	1	10
00271	1.99	47	51	2	25	1	10
00272	2.00		51	2	25	1	10
00273	2.05		54	2 1/8	29	1 5/32	10
00274	2.06	46	54	2 1/8	29	1 5/32	10
00280	2.08	45	54	2 1/8	29	1 5/32	10
00281	2.10		54	2 1/8	29	1 5/32	10
00282	2.15		54	2 1/8	29	1 5/32	10
00283	2.18	44	54	2 1/8	29	1 5/32	10
00284	2.20		57	2 1/4	32	1 1/4	10
00290	2.25		57	2 1/4	32	1 1/4	10
00291	2.26	43	57	2 1/4	32	1 1/4	10
00292	2.30		57	2 1/4	32	1 1/4	10
00293	2.35		57	2 1/4	32	1 1/4	10
00294	2.37	42	57	2 1/4	30	1 3/16	10
00300	2.38	3/32	57	2 1/4	30	1 3/16	10
00301	2.40		57	2 1/4	30	1 3/16	10
00302	2.44	41	57	2 1/4	30	1 3/16	10
00303	2.45		57	2 1/4	30	1 3/16	10
00304	2.49	40	57	2 1/4	30	1 3/16	10
00310	2.50		57	2 1/4	30	1 3/16	10
00311	2.53	39	57	2 1/4	30	1 3/16	10
00231	2.55		57	2 1/4	30	1 3/16	10
00312	2.58	38	57	2 1/4	30	1 3/16	10
00313	2.60		57	2 1/4	30	1 3/16	10
00314	2.64	37	57	2 1/4	30	1 3/16	10
00251	2.65		57	2 1/4	30	1 3/16	10
00320	2.70		61	2 13/32	33	1 19/64	10
00321	2.71	36	61	2 13/32	33	1 19/64	10
00261	2.75		61	2 13/32	33	1 19/64	10

Part #	Dia. MM	Frac/ Wire/ Letter	Overall Length		Flute Length		Qty. per/pack
			MM	Inches	MM	Inches	
00322	2.78	7/64	61	2 13/32	33	1 19/64	10
00323	2.79	35	61	2 13/32	33	1 19/64	10
00324	2.80		61	2 13/32	33	1 19/64	10
00330	2.82	34	61	2 13/32	33	1 19/64	10
00360	2.85		61	2 13/32	33	1 19/64	10
00331	2.87	33	61	2 13/32	33	1 19/64	10
00332	2.90		61	2 13/32	33	1 19/64	10
00333	2.95	32	61	2 13/32	33	1 19/64	10
00334	3.00		61	2 13/32	33	1 19/64	10
00340	3.05	31	65	2 9/16	36	1 7/16	10
00341	3.10		65	2 9/16	36	1 7/16	10
00342	3.17	1/8	65	2 9/16	36	1 7/16	10
00343	3.20		65	2 9/16	36	1 7/16	10
00371	3.25		65	2 9/16	36	1 7/16	10
00344	3.26	30	65	2 9/16	36	1 7/16	10
00350	3.30		65	2 9/16	36	1 7/16	10
00351	3.40		70	2 3/4	39	1 17/32	10
00352	3.45	29	70	2 3/4	39	1 17/32	10
00353	3.50		70	2 3/4	39	1 17/32	10
00354	3.57	9/64-28	70	2 3/4	39	1 17/32	10
00361	3.60		70	2 3/4	39	1 17/32	10
00362	3.66	27	70	2 3/4	39	1 17/32	10
00363	3.70		70	2 3/4	39	1 17/32	10
00364	3.73	26	70	2 3/4	39	1 17/32	10
00370	3.80	25	75	2 15/16	43	1 11/16	10
00372	3.86	24	75	2 15/16	43	1 11/16	10
00373	3.90		75	2 15/16	43	1 11/16	10
00374	3.91	23	75	2 15/16	43	1 11/16	10
00380	3.97	5/32	75	2 15/16	43	1 11/16	10
00381	3.99	22	75	2 15/16	43	1 11/16	10
00382	4.00		75	2 15/16	43	1 11/16	10
00383	4.04	21	75	2 15/16	43	1 11/16	10
00384	4.09	20	75	2 15/16	43	1 11/16	10
00390	4.10		75	2 15/16	43	1 11/16	10
00391	4.15		75	2 15/16	43	1 11/16	10
00392	4.20		75	2 15/16	43	1 11/16	10
00393	4.22	19	75	2 15/16	43	1 11/16	10
00480	4.25		75	2 15/16	43	1 11/16	10
00394	4.30		80	3 5/32	47	1 27/32	10
00680	4.31	18	80	3 5/32	47	1 27/32	10
00400	4.37	11/64	80	3 5/32	47	1 27/32	10
00401	4.39	17	80	3 5/32	47	1 27/32	10
00402	4.40		80	3 5/32	47	1 27/32	10
00403	4.50	16	80	3 5/32	47	1 27/32	10
00404	4.55		80	3 5/32	47	1 27/32	10
00410	4.57	15	80	3 5/32	47	1 27/32	10
00411	4.60		80	3 5/32	47	1 27/32	10
00412	4.62	14	80	3 5/32	47	1 27/32	10
00413	4.70	13	80	3 5/32	47	1 27/32	10
00414	4.75		80	3 5/32	47	1 27/32	10
00420	4.76	3/16	86	3 3/8	52	2 1/16	10
00421	4.80	12	86	3 3/8	52	2 1/16	10
00423	4.85	11	86	3 3/8	52	2 1/16	10
00424	4.90		86	3 3/8	52	2 1/16	10
00430	4.91	10	86	3 3/8	52	2 1/16	10
00431	4.98	9	86	3 3/8	52	2 1/16	10
00432	5.00		86	3 3/8	52	2 1/16	10
00433	5.05	8	86	3 3/8	52	2 1/16	10
00434	5.10		86	3 3/8	52	2 1/16	10
00440	5.11	7	86	3 3/8	52	2 1/16	10
00441	5.16	13/64	86	3 3/8	52	2 1/16	10
00442	5.18	6	86	3 3/8	52	2 1/16	10
00443	5.20		86	3 3/8	52	2 1/16	10
00444	5.22	5	86	3 3/8	52	2 1/16	10
00481	5.25		86	3 3/8	52	2 7/32	10
00450	5.30		93	3 21/32	57	2 7/32	10
00451	5.31	4	93	3 21/32	57	2 7/32	10
00452	5.40		93	3 21/32	57	2 7/32	10
00453	5.41	3	93	3 21/32	57	2 7/32	10

METRIC sizes continued on page 33

DIN Length

METRIC

Part #	Dia. MM	Frac/ Wire/ Letter	Overall Length		Flute Length		Qty. per/pack
			MM	Inches	MM	Inches	
00454	5.50		93	3 21/32	57	2 7/32	10
00460	5.56	7/32	93	3 21/32	57	2 7/32	10
00461	5.60		93	3 21/32	57	2 7/32	10
00462	5.61	2	93	3 21/32	57	2 7/32	10
00463	5.70		93	3 21/32	57	2 7/32	10
00482	5.75		93	3 21/32	57	2 7/32	10
00464	5.79	1	93	3 21/32	57	2 7/32	10
00470	5.80		93	3 21/32	57	2 7/32	10
00471	5.90		93	3 21/32	57	2 7/32	10
00472	5.94	A	93	3 21/32	57	2 7/32	10
00473	5.95	15/64	93	3 21/32	57	2 7/32	10
00474	6.00		93	3 21/32	57	2 7/32	10
00483	6.05	B	101	3 31/32	63	2 15/32	10
00484	6.10		101	3 31/32	63	2 15/32	10
00490	6.15	C	101	3 31/32	63	2 15/32	10
00491	6.20		101	3 31/32	63	2 15/32	10
00492	6.25	D	101	3 31/32	63	2 15/32	10
00493	6.30		101	3 31/32	63	2 15/32	10
00494	6.35	1/4-E	101	3 31/32	63	2 15/32	10
00500	6.40		101	3 31/32	63	2 15/32	10
00501	6.50		101	3 31/32	63	2 15/32	10
00502	6.53	F	101	3 31/32	63	2 15/32	10
00503	6.60		101	3 31/32	63	2 15/32	10
00504	6.63	G	101	3 31/32	63	2 15/32	10
00510	6.70		101	3 31/32	63	2 15/32	10
00511	6.75	17/64-H	109	4 9/32	69	2 23/32	10
00513	6.80		109	4 9/32	69	2 23/32	10
00514	6.90	I	109	4 9/32	69	2 23/32	10
00520	7.00		109	4 9/32	69	2 23/32	10
00521	7.04	J	109	4 9/32	69	2 23/32	10
00522	7.10		109	4 9/32	69	2 23/32	10
00524	7.14	9/32-K	109	4 9/32	69	2 23/32	10
00530	7.20		109	4 9/32	69	2 23/32	10
00531	7.30		109	4 9/32	69	2 23/32	10
00532	7.37	L	109	4 9/32	69	2 23/32	10
00533	7.40		109	4 9/32	69	2 23/32	10
00540	7.50	M	109	4 9/32	69	2 23/32	5
00541	7.54	19/64	117	4 19/32	75	2 15/16	5
00542	7.60		117	4 19/32	75	2 15/16	5
00543	7.67	N	117	4 19/32	75	2 15/16	5
00544	7.70		117	4 19/32	75	2 15/16	5
00550	7.80		117	4 19/32	75	2 15/16	5
00551	7.90		117	4 19/32	75	2 15/16	5
00552	7.94	5/16	117	4 19/32	75	2 15/16	5
00553	8.00	O	117	4 19/32	75	2 15/16	5
00554	8.03		117	4 19/32	75	2 15/16	5
00560	8.10	P	117	4 19/32	75	2 15/16	5
00561	8.20		117	4 19/32	75	2 15/16	5
00562	8.30		117	4 19/32	75	2 15/16	5
00563	8.33	21/64	117	4 19/32	75	2 15/16	5
00564	8.40		117	4 19/32	75	2 15/16	5
00570	8.43	Q	117	4 19/32	75	2 15/16	5
00571	8.50		117	4 19/32	75	2 15/16	5
00572	8.60	R	125	4 29/32	81	3 3/16	5
00573	8.70		125	4 29/32	81	3 3/16	5
00574	8.73	11/32	125	4 29/32	81	3 3/16	5
00580	8.80		125	4 29/32	81	3 3/16	5
00581	8.84	S	125	4 29/32	81	3 3/16	5
00582	8.90		125	4 29/32	81	3 3/16	5
00583	9.00		125	4 29/32	81	3 3/16	5
00584	9.10	T	125	4 29/32	81	3 3/16	5
00590	9.13	23/64	125	4 29/32	81	3 3/16	5
00591	9.20		125	4 29/32	81	3 3/16	5
00592	9.30		125	4 29/32	81	3 3/16	5
00593	9.35	U	125	4 29/32	81	3 3/16	5
00594	9.40		125	4 29/32	81	3 3/16	5
00600	9.50		125	4 29/32	81	3 3/16	5
00601	9.52	3/8	125	4 29/32	87	3 7/16	5
00602	9.58	V	125	4 29/32	87	3 7/16	5
00603	9.60		133	5 1/4	87	3 7/16	5
00604	9.70		133	5 1/4	87	3 7/16	5
00610	9.80	W	133	5 1/4	87	3 7/16	5
00611	9.90		133	5 1/4	87	3 7/16	5
00612	9.92	25/64	133	5 1/4	87	3 7/16	5

HSS M42 COBALT DIN 338

Type XGT-J METRIC

DIN 338 Length - 135° Split Point
M-42 Cobalt High-Speed Steel

Part #	Dia. MM	Frac/ Wire/ Letter	Overall Length		Flute Length		Qty. per/pack
			MM	Inches	MM	Inches	
00613	10.00		133	5 1/4	87	3 7/16	5
00614	10.08	X	133	5 1/4	87	3 7/16	5
00620	10.10		133	5 1/4	87	3 7/16	5
00621	10.20		133	5 1/4	87	3 7/16	5
00622	10.26	Y	133	5 1/4	87	3 7/16	5
00623	10.30		133	5 1/4	87	3 7/16	5
00624	10.32	13/32	133	5 1/4	87	3 7/16	5
00630	10.40		133	5 1/4	87	3 7/16	5
00631	10.50	Z	133	5 1/4	87	3 7/16	5
00632	10.60		133	5 1/4	87	3 7/16	5
00633	10.70		142	5 19/32	94	3 11/16	5
00634	10.72	27/64	142	5 19/32	94	3 11/16	5
00640	10.80		142	5 19/32	94	3 11/16	5
00641	10.90		142	5 19/32	94	3 11/16	5
00642	11.00		142	5 19/32	94	3 11/16	5
00643	11.10		142	5 19/32	94	3 11/16	5
00644	11.11	7/16	142	5 19/32	94	3 11/16	5
00650	11.20		142	5 19/32	94	3 11/16	5
00651	11.30		142	5 19/32	94	3 11/16	5
00652	11.40		142	5 19/32	94	3 11/16	5
00653	11.50		142	5 19/32	94	3 11/16	5
00654	11.51	29/64	142	5 19/32	94	3 11/16	5
00660	11.60		142	5 19/32	94	3 11/16	5
00661	11.70		142	5 19/32	94	3 11/16	5
00662	11.75		142	5 19/32	94	3 11/16	5
00663	11.80		142	5 19/32	94	3 11/16	5
00664	11.91	15/32	151	5 15/16	101	3 31/32	5
00670	12.00		151	5 15/16	101	3 31/32	5
00671	12.30	31/64	151	5 15/16	101	3 31/32	5
00672	12.50		151	5 15/16	101	3 31/32	5
00673	12.70	1/2	151	5 15/16	101	3 31/32	5
00674	13.00		151	5 15/16	101	3 31/32	5

HSS M42 COBALT DIN 338

Type XGT-JN TiN Titanium Nitride
DIN 338 Length - 135° Split Point M-42 Cobalt



Part No.	Diameter Inches	Overall Length Inches	Flute Length Inches	Qty. per/pack
38613	5/64	2	1	10
38623	3/32	2-1/4	1-3/16	10
38633	7/64	2-13/32	1-19/64	10
38643	1/8	2-9/16	1-7/16	10
38653	9/64	2-3/4	1-17/32	10
38663	5/32	2-15/16	1-11/16	10
38673	11/64	3-5/32	1-27/32	10
38683	3/16	3-3/8	2-1/16	10
38693	13/64	3-1/8	2-1/16	10
38703	7/32	3-21/32	2-7/32	10
38713	15/64	3-21/32	2-7/32	10
38723	1/4	3-31/32	2-15/32	10
38733	17/64	4-9/32	2-23/32	10
38743	9/32	4-9/32	2-23/32	10
38753	19/64	4-19/32	2-15/16	5
38763	5/16	4-19/32	2-15/16	5
38773	21/64	4-19/32	2-15/16	5
38783	11/32	4-29/32	3-3/16	5
38793	23/64	4-29/32	3-3/16	5
38803	3/8	4-29/32	3-7/16	5
38813	25/64	5-1/4	3-7/16	5
38823	13/32	5-1/4	3-7/16	5
38833	27/64	5-19/32	3-11/16	5
38843	7/16	5-19/32	3-11/16	5
38853	29/64	5-19/32	3-11/16	5
38863	15/32	5-15/16	3-31/32	5
38873	31/64	5-15/16	3-31/32	5
38883	1/2	5-15/16	3-31/32	5

Screw Machine Length

NAS 907C - SCREW MACHINE

Type 135-AG - NAS 907C

Magnum Super Premium, 135° Split Point

- Special Hi-Moybdenum tool steel.
- Gold surface treated body and clearance for maximum lubricity.
- Heavy-duty construction, 135° split point, no center punch needed - will not walk.
- Recommended for work hardening grades of stainless steel and other hard metal drilling applications.



FRACTIONAL

Part #	Diameter Inches	Overall Length Inches	Flute Length Inches	Qty. per/pack
87710	1/16	1-5/8	5/8	12
87720	5/64	1-11/16	11/16	12
87730	3/32	1-3/4	3/4	12
87740	7/64	1-13/16	13/16	12
87750	1/8	1-7/8	7/8	12
87760	9/64	1-15/16	15/16	12
87770	5/32	2-1/16	1	12
87780	11/64	2-1/8	1-1/16	12
87790	3/16	2-3/16	1-1/8	12
87800	13/64	2-1/4	1-3/16	12
87810	7/32	2-3/8	1-1/4	12
87820	15/64	2-7/16	1-5/16	12
87830	1/4	2-1/2	1-3/8	12
87840	17/64	2-5/8	1-7/16	12
87850	9/32	2-11/16	1-1/2	12
87860	19/64	2-3/4	1-9/16	6
87870	5/16	2-13/16	1-5/8	6
87880	21/64	2-15/16	1-11/16	6
87890	11/32	3"	1-11/16	6
87900	23/64	3-1/16	1-3/4	6
87910	3/8	3-1/8	1-13/16	6
87920	25/64	3-1/4	1-7/8	6
87930	13/32	3-5/16	1-15/16	6
87940	27/64	3-3/8	2	6
87950	7/16	3-7/16	2-1/16	6
87960	29/64	3-9/16	2-1/8	6
87970	15/32	3-5/8	2-1/8	6
87980	31/64	3-11/16	2-3/16	6
87990	1/2	3-3/4	2-1/4	6
88000	33/64	3-7/8	2-3/8	1
88010	17/32	3-7/8	2-3/8	1
88020	35/64	4"	2-1/2	1
88030	9/16	4"	2-1/2	1
88040	37/64	4-1/8	2-5/8	1
88050	19/32	4-1/8	2-5/8	1
88060	39/64	4-1/4	2-3/4	1
88070	5/8	4-1/4	2-3/4	1
88080	41/64	4-1/2	2-7/8	1
88090	21/32	4-1/2	2-7/8	1
89210	43/64	4-1/2	2-7/8	1
89220	11/16	4-1/2	2-7/8	1
89230	45/64	4-3/4	3	1
89240	23/32	4-3/4	3	1
89250	47/64	5"	3-1/8	1
89260	3/4	5"	3-1/8	1

WIRE

Part #	Wire Sizes	Overall Length Inches	Flute Length Inches	Qty. per/pack
87600	1	2-7/16	1-5/16	12
87590	2	2-7/16	1-5/16	12
87580	3	2-3/8	1-1/4	12
87570	4	2-3/8	1-1/4	12
87560	5	2-3/8	1-1/4	12
87550	6	2-3/8	1-1/4	12
87540	7	2-1/4	1-3/16	12
87530	8	2-1/4	1-3/16	12
87520	9	2-1/4	1-3/16	12
87510	10	2-1/4	1-3/16	12
87500	11	2-1/4	1-3/16	12
87490	12	2-1/4	1-3/16	12
87480	13	2-3/16	1-1/8	12
87470	14	2-3/16	1-1/8	12
87460	15	2-3/16	1-1/8	12
87450	16	2-3/16	1-1/8	12
87440	17	2-3/16	1-1/8	12
87430	18	2-1/8	1-1/16	12
87420	19	2-1/8	1-1/16	12
87410	20	2-1/8	1-1/16	12
87400	21	2-1/8	1-1/16	12
87390	22	2-1/8	1-1/16	12
87380	23	2-1/16	1	12
87370	24	2-1/16	1	12
87360	25	2-1/16	1	12
87350	26	2-1/16	1	12
87340	27	2-1/16	1	12
87330	28	1-15/16	15/16	12
87320	29	1-15/16	15/16	12
87310	30	1-15/16	15/16	12
87300	31	1-7/8	7-8	12
87290	32	1-7/8	7-8	12
87280	33	1-7/8	7-8	12
87270	34	1-7/8	7-8	12
87260	35	1-7/8	7-8	12
87250	36	1-13/16	13/16	12
87240	37	1-13/16	13/16	12
87230	38	1-13/16	13/16	12
87220	39	1-13/16	13/16	12
87210	40	1-13/16	13/16	12
23360	41	1-13/16	13/16	12
23370	42	1-3/4	3/4	12
23380	43	1-3/4	3/4	12
23390	44	1-3/4	3/4	12
23400	45	1-3/4	3/4	12
23410	46	1-3/4	3/4	12
23420	47	1-3/4	3/4	12
23430	48	1-11/16	11/16	12
23440	49	1-11/16	11/16	12
23450	50	1-11/16	11/16	12
23460	51	1-11/16	11/16	12
23470	52	1-11/16	11/16	12
23480	53	1-5/8	5/8	12
23490	54	1-5/8	5/8	12
23500	55	1-5/8	5/8	12
23510	56	1-3/8	1/2	12
23520	57	1-3/8	1/2	12
23530	58	1-3/8	1/2	12
23540	59	1-3/8	1/2	12
23550	60	1-3/8	1/2	12

Letter sizes continued on page 35

Screw Machine Length

NAS 907C - SCREW MACHINE

Type 135-AG - NAS 907C

Magnum Super Premium, 135° Split Point

- Special Hi-Moybdenum tool steel.
- Gold surface treated body and clearance for maximum lubricity.
- Heavy-duty construction, 135° split point, no center punch needed - will not walk.
- Recommended for work hardening grades of stainless steel and other hard metal drilling applications.



LETTER

Part #	Letter Sizes	Overall Length Inches	Flute Length Inches	Qty. per/pack
23601	A	2-7/16	1-5/16	12
23611	B	2-1/2	1-3/8	12
23621	C	2-1/2	1-3/8	12
23631	D	2-1/2	1-3/8	12
23641	E	2-1/2	1-3/8	12
23651	F	2-5/8	1-7/16	12
23661	G	2-5/8	1-7/16	12
23671	H	2-11/16	1-1/2	12
23681	I	2-11/16	1-1/2	12
23691	J	2-11/16	1-1/2	12
23701	K	2-11/16	1-1/2	12
23711	L	2-3/4	1-9/16	12
23721	M	2-3/4	1-9/16	6
23731	N	2-13/16	1-5/8	6
23741	O	2-15/16	1-11/16	6
23751	P	2-15/16	1-11/16	6
23761	Q	3"	1-11/16	6
23771	R	3"	1-11/16	6
23781	S	3-1/16	1-3/4	6
23791	T	3-1/16	1-3/4	6
23801	U	3-1/8	1-13/16	6
23811	V	3-1/4	1-7/8	6
23821	W	3-1/4	1-7/8	6
23831	X	3-5/16	1-15/16	6
23841	Y	3-5/16	1-15/16	6
23851	Z	3-3/8	2"	6

M42 COBALT - TiN & TITANIUM ALUMINUM NITRIDE SCREW MACHINE

Type 260-D - M42 Cobalt, Type 260-DN - Titanium

Nitride, Type 260-AND - Titanium Aluminum Nitride 135° Split Point - M42 Cobalt Steel

- Manufactured from M42 HSS contains 8% Cobalt increasing hot hardness.
- High hot hardness of cobalt permits speeds 30% over regular high-speed steel drills.
- Titanium Aluminum Nitride can be used in machining stainless steel, nickel based and titanium alloys, not recommended for aluminum.



Type 260-D

Use to drill hard, tough metals, free machining stainless steel, titanium alloys and certain abrasive plastics.



Type 260-DN

TiN coating for lubricity, abrasion resistance extended tool life.



Type 260-AND

Titanium aluminum nitride designed for use where extreme temperatures are found, allows for increased machining speeds up to 200%.

260-D Part #	260-DN TiN Part #	260-AND TiAlN Part #	Dia. Inches	Overall Length Inches	Flute Length Inches	260-D Qty. per/Pk	260-DN/260-AND Qty. per/Pk
39800	81800	37103	1/16	1-5/8	5/8	12	6
39810	81810	37113	5/64	1-11/16	11/16	12	6
39820	81820	37123	3/32	1-3/4	3/4	12	6
39830	81830	37133	7/64	1-13/16	13/16	12	6
39840	81840	37143	1/8"	1-7/8	7/8	12	6
39850	81850	37153	9/64	1-15/16	15/16	12	6
39860	81860	37163	5/32	2-1/16	1	12	6
39870	81870	37173	11/64	2-1/8	1-1/16	12	6
39880	81880	37183	3/16	2-3/16	1-1/8	12	6
39890	81890	37193	13/64	2-1/4	1-3/16	12	6
39900	81900	37203	7/32	2-3/8	1-1/4	12	6
39910	81910	37213	15/64	2-7/16	1-5/16	12	6
39920	81920	37223	1/4"	2-1/2	1-3/8	12	6
39930	81930	37233	17/64	2-5/8	1-7/16	12	6
39940	81940	37243	9/32	2-11/16	1-1/2	12	6
39950	81950	37253	19/64	2-3/4	1-9/16	6	3
39960	81960	37263	5/16	2-13/16	1-5/8	6	3
39970	81970	37273	21/64	2-15/16	1-11/16	6	3
39980	81980	37283	11/32	3	1-11/16	6	3
39990	81990	37293	23/64	3-1/16	1-3/4	6	3
40000	82000	37303	3/8"	3-1/8	1-13/16	6	3
40010	82010	37313	25/64	3-1/4	1-7/8	6	3
40020	82020	37323	13/32	3-5/16	1-15/16	6	3
40030	82030	37333	27/64	3-3/8	2	6	3
40040	82040	37343	7/16"	3-7/16	2-1/16	6	3
40050	82050	37353	29/64	3-9/16	2-1/8	6	3
40060	82060	37363	15/32	3-5/8	2-1/8	6	3
40070	82070	37373	31/64	3-11/16	2-3/16	6	3
40080	82080	37383	1/2"	3-3/4	2-1/4	6	3
51630	----	----	33/64	3-7/8	2-3/8	1	--
51640	----	----	17/32	3-7/8	2-3/8	1	--
51650	----	----	35/64	4	2-1/2	1	--
51660	----	----	9/16	4	2-1/2	1	--
51670	----	----	37/64	4-1/8	2-5/8	1	--
51680	----	----	19/32	4-1/8	2-5/8	1	--
51690	----	----	39/64	4-1/4	2-3/4	1	--
51700	----	----	5/8"	4-1/4	2-3/4	1	--
51710	----	----	41/64	4-1/2	2-7/8	1	--
51720	----	----	21/32	4-1/2	2-7/8	1	--
51730	----	----	43/64	4-1/2	2-7/8	1	--
51740	----	----	11/16	4-1/2	2-7/8	1	--
51750	----	----	45/64	4-3/4	3	1	--
51760	----	----	23/32	4-3/4	3	1	--
51770	----	----	47/64	5	3-1/8	1	--
51780	----	----	3/4"	5	3-1/8	1	--

Screw Machine Length

Black & Gold

M42 COBALT - TiN & TITANIUM ALUMINUM NITRIDE SCREW MACHINE

Type 260-D - M42 Cobalt, Type 260-DN - Titanium Nitride, Type 260-AND - Titanium Aluminum Nitride 135° Split Point - M42 Cobalt Steel

- Manufactured from M42 HSS contains 8% Cobalt increasing hot hardness.
- High hot hardness of cobalt permits speeds 30% over regular high-speed steel drills.
- Titanium Aluminum Nitride can be used in machining stainless steel, nickel based and titanium alloys, not recommended for aluminum.

WIRE

260-D Part #	Wire Sizes	Overall Length Inches	Flute Length Inches	Qty. per/pack
40090	1	2-7/16	1-5/16	12
40100	2	2-7/16	1-5/16	12
40110	3	2-3/8	1-1/4	12
40120	4	2-3/8	1-1/4	12
40130	5	2-3/8	1-1/4	12
40140	6	2-3/8	1-1/4	12
40150	7	2-1/4	1-3/16	12
40160	8	2-1/4	1-3/16	12
40170	9	2-1/4	1-3/16	12
40180	10	2-1/4	1-3/16	12
40190	11	2-1/4	1-3/16	12
40200	12	2-1/4	1-3/16	12
40210	13	2-3/16	1-1/8	12
40220	14	2-3/16	1-1/8	12
40230	15	2-3/16	1-1/8	12
40240	16	2-3/16	1-1/8	12
40250	17	2-3/16	1-1/8	12
40260	18	2-1/8	1-1/16	12
40270	19	2-1/8	1-1/16	12
40280	20	2-1/8	1-1/16	12
40290	21	2-1/8	1-1/16	12
40300	22	2-1/8	1-1/16	12
40310	23	2-1/16	1	12
40320	24	2-1/16	1	12
40330	25	2-1/16	1	12
40340	26	2-1/16	1	12
40350	27	2-1/16	1	12
40360	28	1-15/16	15/16	12
40370	29	1-15/16	15/16	12
40380	30	1-15/16	15/16	12
40390	31	1-7/8	7/8	12
40400	32	1-7/8	7/8	12
40410	33	1-7/8	7/8	12
40420	34	1-7/8	7/8	12
40430	35	1-7/8	7/8	12
40440	36	1-13/16	13/16	12
40450	37	1-13/16	13/16	12
40460	38	1-13/16	13/16	12
40470	39	1-13/16	13/16	12
40480	40	1-13/16	13/16	12
42410	41	1-13/16	13/16	12
42420	42	1-3/4	3/4	12
42430	43	1-3/4	3/4	12
42440	44	1-3/4	3/4	12
42450	45	1-3/4	3/4	12
42460	46	1-3/4	3/4	12
42470	47	1-3/4	3/4	12
42480	48	1-11/16	11/16	12
42490	49	1-11/16	11/16	12
42500	50	1-11/16	11/16	12
42510	51	1-11/16	11/16	12
42520	52	1-11/16	11/16	12
42530	53	1-5/8	5/8	12
42540	54	1-5/8	5/8	12
42550	55	1-5/8	5/8	12
42560	56	1-3/8	1/2	12
42570	57	1-3/8	1/2	12
42580	58	1-3/8	1/2	12
42590	59	1-3/8	1/2	12
42600	60	1-3/8	1/2	12

HEAVY-DUTY 1/4" REDUCED SHANK

Type 125

1/4" Reduced Shank - Heavy-Duty Surfaced Treated, 135° Split Point

- This HSS drill is recommended for "punch" drilling in hard, tough sheet metal applications where quick and accurately located holes are required.



TYPE 125 1/4" REDUCED SHANK

Part #	Diameter Inches	Overall Length Inches	Flute Length Inches	Qty. per/pack
22410	17/64	2-5/8	1-7/16	12
22420	9/32	2-11/16	1-1/2	12
22430	19/64	2-3/4	1-9/16	6
22440	5/16	2-13/16	1-5/8	6
22450	21/64	2-15/16	1-11/16	6
22460	11/32	3"	1-11/16	6
22470	23/64	3-1/16	1-3/4	6
22480	3/8	3-1/8	1-13/16	6
22490	25/64	3-1/4	1-7/8	6
22500	13/32	3-5/16	1-15/16	6
22510	27/64	3-3/8	2"	6
22520	7/16	3-7/16	2-1/16	6
22530	29/64	3-9/16	2-1/8	6
22540	15/32	3-5/8	2-1/8	6
22550	31/64	3-11/16	2-3/16	6
22560	1/2	3-3/4	2-1/4	6

Screw Machine - M42 Cobalt Heavy-Duty 1/4" Reduced Shank

Screw Machine Length

TiN COATED, BRIGHT FINISHED NAS 907C HEAVY-DUTY



Type 135
Sturdy drill for use in portable power drilling.



Type 260-TW
Bright finish accurate centering, fast penetration.

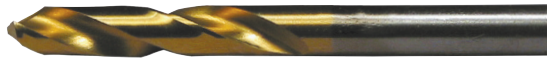

Type 135-TN
Titanium nitride coating provides a super hard surface with high lubricity.

Type 135, Type 135-TN, Type 260-TW NAS 907C Heavy-Duty 135° Split Point

- A sturdy drill for use in portable power drilling.
- Accurate centering, fast penetration. Ideal for thin metal work.
- Sizes smaller than #52 are not split pointed.

NOTE: For letter sizes, see 135-AG page 36

NOTE: * **TiN Coated Package Quantity**
(6 qty. - 1/16 thru 9/32 A-L #1 - 60) (3 qty. - 19/64 - 1/2")

NOTE: * **TiN Coated Package Quantity**
(6 qty. - 1/16 thru 9/32 A-L #1 - 60) (3 qty. - 19/64 - 1/2")

FRACTIONAL

Type 135 Part #	Type *135-TN Part #	Type 260-TW Part #	Diameter Inches	Overall Length Inches	Flute Length Inches	Qty. per/pack
25560	97600	52240	1/16"	1-5/8	5/8	12
25570	97590	52250	5/64	1-11/16	11/16	12
25580	97580	52260	3/32	1-3/4	3/4	12
25590	97570	52270	7/64	1-13/16	13/16	12
25600	97560	52280	1/8"	1-7/8	7/8	12
25610	97550	52290	9/64	1-15/16	15/16	12
25620	97540	52300	5/32	2-1/16	1	12
25630	97530	52310	11/64	2-1/8	1-1/16	12
25640	97520	52320	3/16	2-3/16	1-1/8	12
25650	97510	52330	13/64	2-1/4	1-3/16	12
25660	97500	52340	7/32	2-3/8	1-1/4	12
25670	97490	52350	15/64	2-7/16	1-5/16	12
25680	97480	52360	1/4"	2-1/2	1-3/8	12
25690	97470	52370	17/64	2-5/8	1-7/16	12
25700	97460	52380	9/32	2-11/16	1-1/2	12
25710	97450	52390	19/64	2-3/4	1-9/16	6
25720	97440	52400	5/16"	2-13/16	1-5/8	6
25730	97430	52410	21/64	2-15/16	1-11/16	6
25740	97420	52420	11/32	3	1-11/16	6
25750	97410	52430	23/64	3-1/16	1-3/4	6
25760	97400	52440	3/8"	3-1/8	1-13/16	6
25770	97390	52450	25/64	3-1/4	1-7/8	6
25780	97380	52460	13/32	3-5/16	1-15/16	6
25790	97370	52470	27/64	3-3/8	2	6
25800	97360	52480	7/16"	3-7/16	2-1/16	6
25810	97350	52490	29/64	3-9/16	2-1/8	6
25820	97340	52500	15/32	3-5/8	2-1/8	6
25830	97330	52510	31/64	3-11/16	2-3/16	6
25840	97320	52520	1/2"	3-3/4	2-1/4	6

For Letter Sizes use Type 135-AG page 35

NOTE: * **TiN Coated Package Quantity**
(6 qty. - 1/16 thru 9/32 A-L #1 - 60) (3 qty. - 19/64 - 1/2")

WIRE

Type 135 Part #	Type *135-TN Part #	Type 260-TW Part #	Wire Sizes	Overall Length Inches	Flute Length Inches	Qty. per/pack
25850	96670	52530	1	2-7/16	1-5/16	12
25860	96660	52540	2	2-7/16	1-5/16	12
25870	96650	52550	3	2-3/8	1-1/4	12
25880	96640	52560	4	2-3/8	1-1/4	12
25890	96630	52570	5	2-3/8	1-1/4	12
25900	96620	52580	6	2-3/8	1-1/4	12
25910	96610	52590	7	2-1/4	1-3/16	12
25920	96600	52600	8	2-1/4	1-3/16	12

WIRE - CONTINUED

Type 135 Part #	Type *135-TN Part #	Type 260-TW Part #	Wire Sizes	Overall Length Inches	Flute Length Inches	Qty. per/pack
25930	96590	52610	9	2-1/4	1-3/16	12
25940	96580	52620	10	2-1/4	1-3/16	12
25960	96570	52630	11	2-1/4	1-3/16	12
25970	96560	52640	12	2-1/4	1-3/16	12
25980	96550	52650	13	2-3/16	1-1/8	12
25990	96540	52660	14	2-3/16	1-1/8	12
26000	96530	52670	15	2-3/16	1-1/8	12
26010	96520	52680	16	2-3/16	1-1/8	12
26020	96510	52690	17	2-3/16	1-1/8	12
26030	96500	52700	18	2-1/8	1-1/16	12
26040	96490	52710	19	2-1/8	1-1/16	12
26050	96480	52720	20	2-1/8	1-1/16	12
26060	96470	52730	21	2-1/8	1-1/16	12
26070	96460	52740	22	2-1/8	1-1/16	12
26080	96450	52750	23	2-1/16	1	12
26090	96440	52760	24	2-1/16	1	12
26100	96430	52770	25	2-1/16	1	12
26110	96420	52780	26	2-1/16	1	12
26120	96410	52790	27	2-1/16	1	12
26130	96400	52800	28	1-15/16	15/16	12
26140	96390	52810	29	1-15/16	15/16	12
26150	96380	52820	30	1-15/16	15/16	12
26160	96370	52830	31	1-7/8	7/8	12
26170	96360	52840	32	1-7/8	7/8	12
26180	96350	52850	33	1-7/8	7/8	12
26190	96340	52860	34	1-7/8	7/8	12
26200	96330	52870	35	1-7/8	7/8	12
26210	96320	52880	36	1-13/16	13/16	12
26220	96310	52890	37	1-13/16	13/16	12
26230	96300	52900	38	1-13/16	13/16	12
26240	96290	52910	39	1-13/16	13/16	12
26250	96280	52920	40	1-13/16	13/16	12
26260	96270	52930	41	1-13/16	13/16	12
26270	96260	52940	42	1-3/4	3/4	12
26280	96250	52950	43	1-3/4	3/4	12
26290	96240	52960	44	1-3/4	3/4	12
26300	96230	52970	45	1-3/4	3/4	12
26310	96220	52980	46	1-3/4	3/4	12
26320	96210	52990	47	1-3/4	3/4	12
26330	96200	53000	48	1-11/16	11/16	12
26340	96190	53010	49	1-11/16	11/16	12
26350	96180	53020	50	1-11/16	11/16	12
26360	96170	53030	51	1-11/16	11/16	12
26370	96160	53040	52	1-11/16	11/16	12
26380	96150	53050	53	1-5/8	5/8	12
26390	96140	53060	54	1-5/8	5/8	12
26400	96130	53070	55	1-5/8	5/8	12
26410	96120	53080	56	1-3/8	1/2	12
26420	96110	53090	57	1-3/8	1/2	12
26430	96100	53100	58	1-3/8	1/2	12
26440	96090	53110	59	1-3/8	1/2	12
26450	96080	53120	60	1-3/8	1/2	12

Screw Machine Length

HSS SCREW MACHINE & TITANIUM NITRIDE COATED

Type 260 & Type 260-BN Titanium Nitride Coated 118° point - High-Speed Steel - General Purpose

Bright-Flute thru 3/4" diameter.

Surface treated flutes over 1" diameter.

- Can be used for all screw machine qualified to run in all applications.
- This drill is designed for ease of penetration and to facilitate chip removal in tough, hard materials.
- May also be used in portable drilling equipment.
Drill sizes over 1-1/16" have a reduced shank.



Type 260

The short length of drill and flute makes this an especially rigid drill for greater drilling accuracy.



Type 260-BN

Performs well in mild drilling applications with abrasive wear characteristics.

FRACTIONAL

260 Part #	260-BN TiN Coated Part #	Diameter Inches	Overall Length Inches	Flute Length Inches	260 Qty. per/pack	260-BN Qty. per/pack
23860	-----	3/64	1-3/8	1/2	12	-----
23870	01501	1/16	1-5/8	5/8	12	6
23880	01511	5/64	1-11/16	11/16	12	6
23890	01521	3/32	1-3/4	3/4	12	6
23900	01531	7/64	1-13/16	13/16	12	6
23910	01541	1/8	1-7/8	7/8	12	6
23920	01551	9/64	1-15/16	15/16	12	6
23930	01561	5/32	2-1/16	1	12	6
23940	01571	11/64	2-1/8	1-1/16	12	6
23950	01581	3/16	2-3/16	1-1/8	12	6
23960	01591	13/64	2-1/4	1-3/16	12	6
23970	01601	7/32	2-3/8	1-1/4	12	6
23980	01611	15/64	2-7/16	1-5/16	12	6
23990	01621	1/4	2-1/2	1-3/8	12	6
24000	01631	17/64	2-5/8	1-7/16	12	6
24010	01641	9/32	2-11/16	1-1/2	12	6
24020	01651	19/64	2-3/4	1-9/16	6	3
24030	01661	5/16	2-13/16	1-5/8	6	3
24040	01671	21/64	2-15/16	1-11/16	6	3
24050	01681	11/32	3	1-11/16	6	3
24060	01691	23/64	3-1/16	1-3/4	6	3
24070	01701	3/8	3-1/8	1-13/16	6	3
24080	01711	25/64	3-1/4	1-7/8	6	3
24090	01721	13/32	3-5/16	1-15/16	6	3
24100	01731	27/64	3-3/8	2	6	3
24110	01741	7/16	3-7/16	2-1/16	6	3
24120	01751	29/64	3-9/16	2-1/8	6	3
24130	01761	15/32	3-5/8	2-1/8	6	3
24140	01771	31/64	3-11/16	2-3/16	6	3
24150	01781	1/2	3-3/4	2-1/4	6	3
24160	-----	33/64	3-7/8	2-3/8	1	-----
24170	-----	17/32	3-7/8	2-3/8	1	-----
24180	-----	35/64	4	2-1/2	1	-----
24190	-----	9/16	4	2-1/2	1	-----
24200	-----	37/64	4-1/8	2-5/8	1	-----
24210	-----	19/32	4-1/8	2-5/8	1	-----
24220	-----	39/64	4-1/4	2-3/4	1	-----
24230	-----	5/8	4-1/4	2-3/4	1	-----
24240	-----	41/64	4-1/2	2-7/8	1	-----
24250	-----	21/32	4-1/2	2-7/8	1	-----
24260	-----	43/64	4-1/2	2-7/8	1	-----
24270	-----	11/16	4-1/2	2-7/8	1	-----
24280	-----	45/64	4-3/4	3	1	-----
24290	-----	23/32	4-3/4	3	1	-----
24300	-----	47/64	5	3-1/8	1	-----
24310	-----	3/4	5	3-1/8	1	-----
24320	-----	49/64	5-1/8	3-1/4	1	-----
24330	-----	25/32	5-1/8	3-1/4	1	-----

FRACTIONAL

260 Part #	260-BN TiN Coated	Diameter Inches	Overall Length Inches	Flute Length Inches	260 Qty. per/pack	260-BN Qty. per/pack
24340	-----	51/64	5-1/4	3-3/8	1	-----
24350	-----	13/16	5-1/4	3-3/8	1	-----
24360	-----	53/64	5-3/8	3-1/2	1	-----
24370	-----	27/32	5-3/8	3-1/2	1	-----
24380	-----	55/64	5-3/8	3-1/2	1	-----
24390	-----	7/8	5-3/8	3-1/2	1	-----
24400	-----	57/64	5-5/8	3-5/8	1	-----
24410	-----	29/32	5-5/8	3-5/8	1	-----
24420	-----	59/64	5-3/4	3-3/4	1	-----
24430	-----	15/16	5-3/4	3-3/4	1	-----
24440	-----	61/64	5-7/8	3-7/8	1	-----
24450	-----	31/32	5-7/8	3-7/8	1	-----
24460	-----	63/64	6	4	1	-----
24470	-----	1"	6	4	1	-----
24480	-----	1-1/16	6-1/4	4	1	-----
24490	-----	1-1/8	6-3/8	4	1	-----
24500	-----	1-3/16	6-5/8	4-1/4	1	-----
24510	-----	1-1/4	6-3/4	4-3/8	1	-----
24520	-----	1-5/16	7	4-3/8	1	-----
24530	-----	1-3/8	7-1/8	4-1/2	1	-----
24540	-----	1-7/16	7-3/8	4-3/4	1	-----
24550	-----	1-1/2	7-1/2	4-7/8	1	-----
24560	-----	1-9/16	7-3/4	4-7/8	1	-----
24570	-----	1-5/8	7-3/4	4-7/8	1	-----
24580	-----	1-11/16	8	5-1/8	1	-----
24590	-----	1-3/4	8	5-1/8	1	-----
24600	-----	1-13/16	8-1/4	5-3/8	1	-----
24610	-----	1-7/8	8-1/4	5-3/8	1	-----
24620	-----	1-15/16	8-1/2	5-5/8	1	-----
24630	-----	2"	8-1/2	5-5/8	1	-----

Wire, Letter sizes continued on page 39

Drill Size	Shank Diameter
1-1/16" to 1-1/4"	1"
1-5/16" to 1-1/2"	1-1/4"
1-9/16" to 2"	1-1/2"

Screw Machine Length

HSS SCREW MACHINE & TITANIUM NITRIDE COATED



Type 260

The short length of drill and flute makes this an especially rigid drill for greater drilling accuracy.



Type 260-BN

Performs well in mild drilling applications with abrasive wear characteristics.

Type 260, Type 260-BN Titanium Nitride Coated High-Speed Steel - General Purpose - 118° Point

Bright-Flute thru 3/4" diameter.
Surface treated flutes over 1" diameter.

- The short length of drill and flute makes this an especially rigid drill for greater drilling accuracy.
- May also be used in portable drilling equipment.

WIRE

260-BN 260 TiN Coated		Wire Sizes	Overall Length Inches	Flute Length Inches	260 Qty. per/pack	260-BN Qty. per/pack
Part #	Part #					
24640	24643	1	2-7/16	1-5/16	12	6
24650	24653	2	2-7/16	1-5/16	12	6
24660	24663	3	2-3/8	1-1/4	12	6
24670	24673	4	2-3/8	1-1/4	12	6
24680	24683	5	2-3/8	1-1/4	12	6
24690	24693	6	2-3/8	1-1/4	12	6
24700	24703	7	2-1/4	1-3/16	12	6
24710	24713	8	2-1/4	1-3/16	12	6
24720	24723	9	2-1/4	1-3/16	12	6
24730	24733	10	2-1/4	1-3/16	12	6
24740	24743	11	2-1/4	1-3/16	12	6
24750	24753	12	2-1/4	1-3/16	12	6
24760	24763	13	2-3/16	1-1/8	12	6
24770	24773	14	2-3/16	1-1/8	12	6
24780	24783	15	2-3/16	1-1/8	12	6
24790	24793	16	2-3/16	1-1/8	12	6
24800	24803	17	2-3/16	1-1/8	12	6
24810	24813	18	2-1/8	1-1/16	12	6
24820	24823	19	2-1/8	1-1/16	12	6
24830	24833	20	2-1/8	1-1/16	12	6
24840	24843	21	2-1/8	1-1/16	12	6
24850	24853	22	2-1/8	1-1/16	12	6
24860	24863	23	2-1/16	1	12	6
24870	24873	24	2-1/16	1	12	6
24880	24883	25	2-1/16	1	12	6
24890	24893	26	2-1/16	1	12	6
24900	24903	27	2-1/16	1	12	6
24910	24913	28	1-15/16	15/16	12	6
24920	24923	29	1-15/16	15/16	12	6
24930	24933	30	1-15/16	15/16	12	6
24940	24943	31	1-7/8	7/8	12	6
24950	24953	32	1-7/8	7/8	12	6
24960	24963	33	1-7/8	7/8	12	6
24970	24973	34	1-7/8	7/8	12	6
24980	24983	35	1-7/8	7/8	12	6
24990	24993	36	1-13/16	13/16	12	6
25000	25003	37	1-13/16	13/16	12	6
25010	25013	38	1-13/16	13/16	12	6
25020	25023	39	1-13/16	13/16	12	6
25030	25033	40	1-13/16	13/16	12	6
25040	25043	41	1-13/16	13/16	12	6
25050	25053	42	1-3/4	3/4	12	6
25060	25063	43	1-3/4	3/4	12	6
25070	25073	44	1-3/4	3/4	12	6
25080	25083	45	1-3/4	3/4	12	6
25090	25093	46	1-3/4	3/4	12	6
25100	25103	47	1-3/4	3/4	12	6
25110	25113	48	1-11/16	11/16	12	6
25120	25123	49	1-11/16	11/16	12	6
25130	25133	50	1-11/16	11/16	12	6
25140	25143	51	1-11/16	11/16	12	6
25150	25153	52	1-11/16	11/16	12	6
25160	25163	53	1-5/8	5/8	12	6
25170	25173	54	1-5/8	5/8	12	6
25180	25183	55	1-5/8	5/8	12	6
25190	25193	56	1-3/8	1/2	12	6
25200	25203	57	1-3/8	1/2	12	6
25210	25213	58	1-3/8	1/2	12	6
25220	25223	59	1-3/8	1/2	12	6
25230	25233	60	1-3/8	1/2	12	6

LETTER

260-BN 260 TiN Coated		Letter Sizes	Overall Length Inches	Flute Length Inches	260 Qty. per/pack	260-BN Qty. per/pack
Part #	Part #					
23600	-----	A	2-7/16	1-5/16	12	-----
23610	-----	B	2-1/2	1-3/8	12	-----
23620	-----	C	2-1/2	1-3/8	12	-----
23630	-----	D	2-1/2	1-3/8	12	-----
23640	-----	E	2-1/2	1-3/8	12	-----
23650	-----	F	2-5/8	1-7/16	12	-----
23660	-----	G	2-5/8	1-7/16	12	-----
23670	-----	H	2-11/16	1-1/2	12	-----
23680	-----	I	2-11/16	1-1/2	12	-----
23690	-----	J	2-11/16	1-1/2	12	-----
23700	-----	K	2-11/16	1-1/2	12	-----
23710	-----	L	2-3/4	1-9/16	12	-----
23720	-----	M	2-3/4	1-9/16	6	-----
23730	-----	N	2-13/16	1-5/8	6	-----
23740	-----	O	2-15/16	1-11/16	6	-----
23750	-----	P	2-15/16	1-11/16	6	-----
23760	-----	Q	3	1-11/16	6	-----
23770	-----	R	3	1-11/16	6	-----
23780	-----	S	3-1/16	1-3/4	6	-----
23790	-----	T	3-1/16	1-3/4	6	-----
23800	-----	U	3-1/8	1-13/16	6	-----
23810	-----	V	3-1/4	1-7/8	6	-----
23820	-----	W	3-1/4	1-7/8	6	-----
23830	-----	X	3-5/16	1-15/16	6	-----
23840	-----	Y	3-5/16	1-15/16	6	-----
23850	-----	Z	3-3/8	2	6	-----

Taper Length

HSS TAPER LENGTH

Type 210

High-Speed Steel 118° Point

- Bright finish thru 1" diameter.
- Surface treated flutes over 1" diameter.
- General purpose 118° point, recommended for mild drilling applications where longer than jobber length drills are required.



FRACTIONAL

Part #	Diameter Inches	Overall Length Inches	Flute Length Inches	Qty. per/pack
10490	3/64	2-1/4	1-1/8	12
10500	1/16	3	1-3/4	12
10510	5/64	3-3/4	2	12
10520	3/32	4-1/4	2-1/4	12
10530	7/64	4-5/8	2-1/2	12
10540	1/8	5-1/8	2-3/4	12
10550	9/64	5-3/8	3	12
10560	5/32	5-3/8	3	12
10570	11/64	5-3/4	3-3/8	12
10580	3/16	5-3/4	3-3/8	12
10590	13/64	6	3-5/8	12
10600	7/32	6	3-5/8	12
10610	15/64	6-1/8	3-3/4	12
10620	1/4	6-1/8	3-3/4	12
10630	17/64	6-1/4	3-7/8	12
10640	9/32	6-1/4	3-7/8	12
10650	19/64	6-3/8	4	6
10660	5/16	6-3/8	4	6
10670	21/64	6-1/2	4-1/8	6
10680	11/32	6-1/2	4-1/8	6
10690	23/64	6-3/4	4-1/4	6
10700	3/8	6-3/4	4-1/4	6
10710	25/64	7	4-3/8	1
10720	13/32	7	4-3/8	1
10730	27/64	7-1/4	4-5/8	1
10740	7/16	7-1/4	4-5/8	1
10750	29/64	7-1/2	4-3/4	1
10760	15/32	7-1/2	4-3/4	1
10770	31/64	7-3/4	4-3/4	1
10780	1/2	7-3/4	4-3/4	1
10790	33/64	8	4-3/4	1
10800	17/32	8	4-3/4	1
10810	35/64	8-1/4	4-7/8	1
10820	9/16	8-1/4	4-7/8	1
10830	37/64	8-3/4	4-7/8	1
10840	19/32	8-3/4	4-7/8	1
10850	39/64	8-3/4	4-7/8	1
10860	5/8	8-3/4	4-7/8	1
10870	41/64	9	5-1/8	1
10880	21/32	9	5-1/8	1
10890	43/64	9-1/4	5-3/8	1
10900	11/16	9-1/4	5-3/8	1
10910	45/64	9-1/2	5-5/8	1
10920	23/32	9-1/2	5-5/8	1
10930	47/64	9-3/4	5-7/8	1
10940	3/4	9-3/4	5-7/8	1
10950	49/64	9-7/8	6	1
10960	25/32	9-7/8	6	1
10970	51/64	10	6-1/8	1
10980	13/16	10	6-1/8	1
10990	53/64	10	6-1/8	1
11000	27/32	10	6-1/8	1
11010	55/64	10	6-1/8	1
11020	7/8	10	6-1/8	1
11030	57/64	10	6-1/8	1
11040	29/32	10	6-1/8	1
11050	59/64	10-3/4	6-1/8	1

FRACTIONAL

Part #	Diameter Inches	Overall Length Inches	Flute Length Inches	Qty. per/pack
11060	15/16	10-3/4	6-1/8	1
11070	61/64	11	6-3/8	1
11080	31/32	11	6-3/8	1
11090	63/64	11	6-3/8	1
11100	1"	11	6-3/8	1
11110	1-1/64	11-1/8	6-1/2	1
11120	1-1/32	11-1/8	6-1/2	1
11130	1-3/64	11-1/4	6-5/8	1
11140	1-1/16	11-1/4	6-5/8	1
11150	1-5/64	11-1/2	6-7/8	1
11160	1-3/32	11-1/2	6-7/8	1
11170	1-7/64	11-3/4	7-1/8	1
11180	1-1/8	11-3/4	7-1/8	1
11190	1-9/64	11-7/8	7-1/4	1
11200	1-5/32	11-7/8	7-1/4	1
11210	1-11/64	12	7-3/8	1
11220	1-3/16	12	7-3/8	1
11230	1-13/64	12-1/8	7-1/2	1
11240	1-7/32	12-1/8	7-1/2	1
11250	1-15/64	12-1/2	7-7/8	1
11260	1-1/4	12-1/2	7-7/8	1
11270	1-9/32	14-1/8	8-1/2	1
11280	1-5/16	14-1/4	8-5/8	1
11290	1-11/32	14-3/8	8-3/4	1
11300	1-3/8	14-1/2	8-7/8	1
11310	1-13/32	14-5/8	9	1
11320	1-7/16	14-3/4	9-1/8	1
11330	1-15/32	14-7/8	9-1/4	1
11340	1-1/2	15	9-3/8	1
11350	1-9/16	15-1/4	9-5/8	1
11360	1-5/8	15-5/8	9-7/8	1
11370	1-3/4	16-1/4	10-1/2	1

WIRE

Part #	Wire Sizes	Overall Length Inches	Flute Length Inches	Qty. per/pack
11640	1	6-1/8	3-3/4	12
11650	2	6-1/8	3-3/4	12
11660	3	6	3-5/8	12
11670	4	6	3-5/8	12
11680	5	6	3-5/8	12
11690	6	6	3-5/8	12
11700	7	6	3-5/8	12
11710	8	6	3-5/8	12
11720	9	6	3-5/8	12
11730	10	6	3-5/8	12
11740	11	6	3-5/8	12
11750	12	6	3-5/8	12
11760	13	5-3/4	3-3/8	12
11770	14	5-3/4	3-3/8	12
11780	15	5-3/4	3-3/8	12
11790	16	5-3/4	3-3/8	12
11800	17	5-3/4	3-3/8	12
11810	18	5-3/4	3-3/8	12
11820	19	5-3/4	3-3/8	12

Wire & Letter sizes continued on page 41

HSS TAPER LENGTH & AUTOMOTIVE TANG DRIVE

Type 210 - (Continued)

WIRE				
Part #	Wire Sizes	Overall Length Inches	Flute Length Inches	Qty. per/pack
11830	20	5-3/4	3-3/8	12
11840	21	5-3/4	3-3/8	12
11850	22	5-3/4	3-3/8	12
11860	23	5-3/8	3	12
11870	24	5-3/8	3	12
11880	25	5-3/8	3	12
11890	26	5-3/8	3	12
11900	27	5-3/8	3	12
11910	28	5-3/8	3	12
11920	29	5-3/8	3	12
11930	30	5-3/8	3	12
11940	31	5-1/8	2-3/4	12
11950	32	5-1/8	2-3/4	12
11960	33	5-1/8	2-3/4	12
11970	34	5-1/8	2-3/4	12
11980	35	5-1/8	2-3/4	12
11990	36	4-5/8	2-1/2	12
12000	37	4-5/8	2-1/2	12
12010	38	4-5/8	2-1/2	12
12020	39	4-5/8	2-1/2	12
12030	40	4-5/8	2-1/2	12
12040	41	4-5/8	2-1/2	12
12050	42	4-1/4	2-1/4	12
12060	43	4-1/4	2-1/4	12
12070	44	4-1/4	2-1/4	12
12080	45	4-1/4	2-1/4	12
12090	46	4-1/4	2-1/4	12
12100	47	4-1/4	2-1/4	12
12110	48	3-3/4	2	12
12120	49	3-3/4	2	12
12130	50	3-3/4	2	12
12140	51	3-3/4	2	12
12150	52	3-3/4	2	12
12160	53	3	1-3/4	12
12170	54	3	1-3/4	12
12180	55	3	1-3/4	12
12190	56	2-1/4	1-1/8	12
12200	57	2-1/4	1-1/8	12
12210	58	2-1/4	1-1/8	12
12220	59	2-1/4	1-1/8	12
12230	60	2-1/4	1-1/8	12

LETTER				
Part #	Letter Sizes	Overall Length Inches	Flute Length Inches	Qty. per/pack
11380	A	6-1/8	3-3/4	12
11390	B	6-1/8	3-3/4	12
11400	C	6-1/8	3-3/4	12
11410	D	6-1/8	3-3/4	12
11420	E	6-1/8	3-3/4	12
11430	F	6-1/4	3-7/8	12
11440	G	6-1/4	3-7/8	12
11450	H	6-1/4	3-7/8	12
11460	I	6-1/4	3-7/8	12
11470	J	6-1/4	3-7/8	12
11480	K	6-1/4	3-7/8	12
11490	L	6-3/8	4	12
11500	M	6-3/8	4	6
11510	N	6-3/8	4	6
11520	O	6-1/2	4-1/8	6
11530	P	6-1/2	4-1/8	6
11540	Q	6-1/2	4-1/8	6
11550	R	6-1/2	4-1/8	6
11560	S	6-3/4	4-1/4	6
11570	T	6-3/4	4-1/4	6
11580	U	6-3/4	4-1/4	6
11590	V	7	4-3/8	1
11600	W	7	4-3/8	1
11610	X	7	4-3/8	1
11620	Y	7	4-3/8	1
11630	Z	7-1/4	4-5/8	1

Type 220

Automotive Series - Tang Drive

High-Speed Steel - General Purpose, 118° point

- Tanged and surface treated. When used with A.S.A. split sleeve drill drivers, these drills serve as economical substitutes for taper shank drills.



FRACTIONAL				
Part #	Diameter Inches	Overall Length Inches	Flute Length Inches	Qty. per/pack
12870	1/8"	5-1/8	2-3/4	12
12880	9/64	5-3/8	3	12
12890	5/32	5-3/8	3	12
12900	11/64	5-3/4	3-3/8	12
12910	3/16"	5-3/4	3-3/8	12
12920	13/64	6	3-5/8	12
12930	7/32	6	3-5/8	12
12940	15/64	6-1/8	3-3/4	12
12950	1/4"	6-1/8	3-3/4	12
12960	17/64	6-1/4	3-7/8	12
12970	9/32	6-1/4	3-7/8	12
12980	19/64	6-3/8	4	6
12990	5/16"	6-3/8	4	6
13000	21/64	6-1/2	4-1/8	6
13010	11/32	6-1/2	4-1/8	6
13020	23/64	6-3/4	4-1/4	6
13030	3/8"	6-3/4	4-1/4	6
13040	25/64	7	4-3/8	1
13050	13/32	7	4-3/8	1
13060	27/64	7-1/4	4-5/8	1
13070	7/16"	7-1/4	4-5/8	1
13080	29/64	7-1/2	4-3/4	1
13090	15/32	7-1/2	4-3/4	1
13100	31/64	7-3/4	4-3/4	1
13110	1/2"	7-3/4	4-3/4	1
13120	33/64	8	4-3/4	1
13130	17/32	8	4-3/4	1
13140	35/64	8-1/4	4-7/8	1
13150	9/16	8-1/4	4-7/8	1
13160	37/64	8-3/4	4-7/8	1
13170	19/32	8-3/4	4-7/8	1
13180	39/64	8-3/4	4-7/8	1
13190	5/8"	8-3/4	4-7/8	1
13200	41/64	9	5-1/8	1
13240	21/32	9	5-1/8	1
13220	43/64	9-1/4	5-3/8	1
13230	11/16	9-1/4	5-3/8	1
72530	47/64	9-3/4	5-7/8	1
72540	3/4"	9-3/4	5-7/8	1

Taper Length

HEAVY DUTY PARABOLIC

Type 221-PT

Heavy-Duty - Parabolic Flute - Taper Length
Titanium Nitride Coated - Tang Drive
135° Split Point

- This high performance drill combines the superior wear resistance of titanium nitride coating, and the deep hole drilling advantages of parabolic flutes.
- The exceptional qualities of these drills can provide high productivity and extended tool life when compared to uncoated high-speed steel.



FRACTIONAL

Part #	Diameter Inches	Overall Length Inches	Flute Length Inches	Qty. per/pack
34600	1/8"	5-1/8	3-3/8	6
34610	9/64	5-3/8	3-5/8	6
34620	5/32	5-3/8	3-3-4	6
34630	11/64	5-3/4	4-1/8	6
34640	3/16"	5-3/4	4-1/8	6
34650	13/64	6	4-3/8	6
34660	7/32	6	4-3/8	6
34670	15/64	6-1/8	4-13/16	6
34680	1/4"	6-1/8	4-13/16	6
34690	17/64	6-1/4	5	6
34700	9/32	6-1/4	5	6
34710	19/64	6-3/8	5-1/8	3
34720	5/16"	6-3/8	5-1/8	3
34730	21/64	6-1/2	5-1/4	3
34740	11/32	6-1/2	5-1/4	3
34750	23/64	6-3/4	5-3/8	3
34760	3/8"	6-3/4	5-3/8	3
34770	25/64	7	5-5/8	1
34780	13/32	7	5-5/8	1
34790	27/64	7-1/4	5-11/16	1
34800	7/16"	7-1/4	5-11/16	1
34810	29/64	7-1/2	5-3/4	1
34820	15/32	7-1/2	5-3/4	1
34830	31/64	7-3/4	5-3/4	1
34840	1/2"	7-3/4	5-3/4	1

Type 221-P

Heavy-Duty - Parabolic Flute Taper Length
Black Oxide - Tang Drive 135° Split Point

- Parabolic flute drills are designed to eliminate the need for frequent drill retraction when deep hole drilling in low to medium tensile strength materials.
- The split point and heavy-duty design provide superior performance by permitting higher feed rates and continuous drilling of deep holes.



FRACTIONAL

Part #	Diameter Inches	Overall Length Inches	Flute Length Inches	Qty. per/pack
35320	1/8"	5-1/8	3-3/8	12
35330	9/64	5-3/8	3-5/8	12
35340	5/32	5-3/8	3-3-4	12
35350	11/64	5-3/4	4-1/8	12
35360	3/16"	5-3/4	4-1/8	12
35370	13/64	6	4-3/8	12
35380	7/32	6	4-3/8	12
35390	15/64	6-1/8	4-13/16	12
35400	1/4"	6-1/8	4-13/16	12
35410	17/64	6-1/4	5	12
35420	9/32	6-1/4	5	12
35430	19/64	6-3/8	5-1/8	6
35440	5/16"	6-3/8	5-1/8	6
35450	21/64	6-1/2	5-1/4	6
35460	11/32	6-1/2	5-1/4	6
35470	23/64	6-3/4	5-3/8	6
35480	3/8"	6-3/4	5-3/8	6
35490	25/64	7	5-5/8	1
35500	13/32	7	5-5/8	1
35510	27/64	7-1/4	5-11/16	1
35520	7/16"	7-1/4	5-11/16	1
35530	29/64	7-1/2	5-3/4	1
35540	15/32	7-1/2	5-3/4	1
35550	31/64	7-3/4	5-3/4	1
35560	1/2"	7-3/4	5-3/4	1

TiN

Twist Drills - Heavy Duty Parabolic Taper Length

EXTRA LENGTH DRILLS & LONGBOY DRILLS

Type XGT-AG

Heavy Duty 135° Split Point - 6", 9", 12"

- Gyroidal Torsion flute and wide land construction yield exceptional performance in deep hole drilling applications.
- Recommended for work hardening grades of stainless steel and other hard metal drilling operations.
- Will drill 12 or more diameters deep without drill removal to clear chips. Feed rates may be twice that of standard drills.



FRACTIONAL

Part #	Size	Overall Length Inches	Flute Length Inches	Qty. per/pack
39240	1/8x6	6	4	3
39250	#29x6	6	4	3
39260	9/64x6	6	4	3
39270	5/32x6	6	4	3
39280	11/64x6	6	4	3
39300	3/16x6	6	4	3
39310	#10x6	6	4	3
39320	13/64x6	6	4	3
39330	7/32x6	6	4	3
39340	#1x6	6	4	3
39350	15/64x6	6	4	3
39360	1/4x6	6	4	3
39370	"F"x6	6	4	3
39380	9/32x6	6	4	3
39390	5/16x6	6	4	3
39400	11/32x6	6	4	3
39410	3/8x6	6	4	1
39420	13/32x6	6	4	1
39430	7/16x6	6	4	1
39440	1/2x6	6	4	1
40780	1/8x9	9	6	1
40890	9/64	9	6	1
40790	5/32x9	9	6	1
53140	11/64	9	6	1
40800	3/16x9	9	6	1
53160	13/64	9	6	1
40810	7/32x9	9	6	1
53180	15/64	9	6	1
40820	1/4x9	9	6	1
40830	9/32x9	9	6	1
40840	5/16x9	9	6	1
40850	11/32x9	9	6	1
40860	3/8x9	9	6	1
40870	7/16x9	9	6	1
40880	1/2x9	9	6	1
43050	1/8x12	12	9	1
53130	9/64	12	9	1
43060	5/32x12	12	9	1
53150	11/64	12	9	1
43070	3/16x12	12	9	1
53170	13/64	12	9	1
43080	7/32x12	12	9	1
53190	15/64	12	9	1
43090	1/4x12	12	9	1
43100	9/32x12	12	9	1
43110	5/16x12	12	9	1
43120	11/32x12	12	9	1
43130	3/8x12	12	9	1
43140	7/16x12	12	9	1
43150	1/2x12	12	9	1

Type 160 & 165

Longboy Drills Bright Finish - 12" & 18"

- General purpose 118° point high-speed steel drill recommended for a wide range of deep hole drilling applications.



TYPE 160 12" LONGBOY

Part #	Diameter Inches	Overall Length Inches	Flute Length Inches	Qty. per/pack
27200	1/8"	12	9	1
27210	9/64	12	9	1
27220	5/32	12	9	1
27230	11/64	12	9	1
27240	3/16	12	9	1
27250	13/64	12	9	1
27260	7/32	12	9	1
27270	15/64	12	9	1
27280	1/4"	12	9	1
27290	17/64	12	9	1
27300	9/32	12	9	1
27310	19/64	12	9	1
27320	5/16	12	9	1
27330	21/64	12	9	1
27340	11/32	12	9	1
27350	23/64	12	9	1
27360	3/8"	12	9	1
27370	25/64	12	9	1
27380	13/32	12	9	1
27390	27/64	12	9	1
27400	7/16	12	9	1
27410	29/64	12	9	1
27420	15/32	12	9	1
27430	31/64	12	9	1
27440	1/2"	12	9	1
27450	17/32	12	9	1
27460	9/16	12	9	1
27470	19/32	12	9	1
27480	5/8	12	9	1
27490	11/16	12	9	1
27500	3/4"	12	9	1

TYPE 165 18" LONGBOY

Part #	Diameter Inches	Overall Length Inches	Flute Length Inches	Qty. per/pack
27600	3/16	18	10	1
27610	7/32	18	10	1
27620	1/4	18	12	1
27630	9/32	18	12	1
27640	5/16	18	12	1
27650	11/32	18	12	1
27660	3/8	18	12	1
27670	13/32	18	12	1
27680	7/16	18	12	1
27690	15/32	18	12	1
27700	1/2	18	12	1
27710	17/32	18	12	1
27720	9/16	18	12	1
27730	19/32	18	12	1
27740	5/8	18	12	1

Aircraft Extension

6" & 12" AIRCRAFT NAS 907B & NAS 907J EXTENSION DRILLS

Heavy - duty 135° split point high-speed steel drills used for drilling holes in hard to reach places.

Type 166 - NAS 907B

Aircraft 6", 135° Split Point
Solid Construction Black Oxide

Type 167-D - NAS 907J

Aircraft 6", 135° Split Point
Solid Construction M42 Cobalt

Type 168 - NAS 907B

12" Extension Drill, Black Oxide

Type 169-D - NAS 907J

12" Extension Drill, M42 Cobalt



Type 166 - NAS 907B

The black surface treatment prevents chip welding and increases abrasion resistance

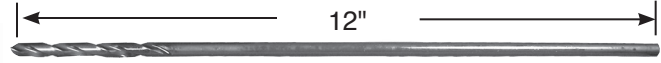

Type 168 - NAS 907B

The black oxide treatment prevents chip welding and increases abrasion resistance



Type 167-D - NAS 907J

M42 Cobalt steel increases heat and abrasion resistance.



Type 169-D - NAS 907J

M42 Cobalt steel increases heat and abrasion resistance.

FRACTIONAL

166 Black Oxide Part #	167-D Cobalt Part #	Diameter Inches	Overall Length Inches	Flute Length Inches	Qty. per/pack
68170	-----	1/16	6	7/8	6
68180	-----	5/64	6	1	6
68470	65090	3/32	6	1-1/4	6
68490	65100	7/64	6	1-1/2	6
68500	65110	1/8	6	1-5/8	6
68510	65120	9/64	6	1-3/4	6
68520	65130	5/32	6	2	6
68530	65140	11/64	6	2-1/8	6
68540	65150	3/16	6	2-5/16	6
68550	65160	13/64	6	2-7/16	6
68560	65170	7/32	6	2-1/2	6
68570	65180	15/64	6	2-5/8	6
68580	65190	1/4	6	2-3/4	6
68190	-----	9/32	6	2-15/16	6
68200	-----	11/32	6	3-7/16	6
68450	-----	21/64	6	3-5/16	6
68760	-----	5/16	6	3-3/16	6
68770	-----	3/8	6	3-5/8	6
68780	-----	7/16	6	4-1/16	6
68790	-----	1/2	6	4-1/2	6

WIRE

166 Black Oxide Part #	167-D Cobalt Part #	Wire Sizes	Overall Length Inches	Flute Length Inches	Qty. per/pack
68590	65200	1	6	2-5/8	6
37400	65210	2	6	2-5/8	6
68330	-----	5	6	2-1/2	6
68600	65220	10	6	2-7/16	6
68610	65230	11	6	2-5/16	6
68350	-----	19	6	2-1/8	6
68620	65240	20	6	2-1/8	6
68630	65250	21	6	2-1/8	6
68370	-----	25	6	1-7/8	6
68640	65260	29	6	1-3/4	6
68650	65270	30	6	1-5/8	6
37490	65280	40	6	1-3/8	6

FRACTIONAL

168 Black Oxide Part #	169-D Cobalt Part #	Diameter Inches	Overall Length Inches	Flute Length Inches	Qty. per/pack
02710	-----	1/16"	12	7/8	1
02720	-----	5/64	12	1	1
02730	-----	3/32	12	1-1/4	1
02740	61800	7/64	12	1-1/2	1
68800	61810	1/8	12	1-5/8	1
68810	61820	9/64	12	1-3/4	1
68820	61830	5/32	12	2	1
68830	61840	11/64	12	2-1/8	1
68840	61850	3/16	12	2-5/16	1
68850	61860	13/64	12	2-7/16	1
68860	61870	7/32	12	2-1/2	1
68870	61880	15/64	12	2-5/8	1
68880	61890	1/4"	12	2-3/4	1
68890	-----	17/64	12	2-7/8	1
68900	-----	9/32	12	2-15/16	1
68910	-----	19/64	12	3-1/16	1
68920	-----	5/16	12	3-3/16	1
68930	-----	21/64	12	3-5/16	1
68940	-----	11/32	12	3-7/16	1
68950	-----	23/64	12	3-1/2	1
68960	-----	3/8"	12	3-5/8	1
68970	-----	25/64	12	3-3/4	1
68980	-----	13/32	12	3-7/8	1
68990	-----	27/64	12	3-15/16	1
69000	-----	7/16"	12	4-1/16	1
69010	-----	29/64	12	4-3/16	1
69020	-----	15/32	12	4-5/16	1
69030	-----	31/64	12	4-3/8	1
69040	-----	1/2"	12	4-1/2	1

WIRE

168 Black Oxide Part #	169-D Cobalt Part #	Wire Sizes	Overall Length Inches	Flute Length Inches	Qty. per/pack
69050	61900	1	12	2-5/8	1
-----	61910	2	12	2-5/8	1
02400	-----	5	12	2-5/8	1
69060	61920	10	12	2-7/16	1
69070	61930	11	12	2-5/16	1
69080	61940	20	12	2-1/8	1
69090	61950	21	12	2-1/8	1
69100	61960	29	12	1-3/4	1
69110	61970	30	12	1-5/8	1
02370	61980	40	12	1-3/8	1

Twist Drills - 6" & 12" AIRCRAFT - TYPE NAS 907B / NAS 907J

PREMIUM & CN-TECH™ 1/2" REDUCED SHANK - SILVER & DEMING

Type 130-AG

1/2" Reduced Shank
Premium, 3-Flats on Shank
Heavy-Duty,
135° Split Point

- Special Hi-Molybdenum tool steel.
- One piece solid construction.
- Sizes greater than 1", 118° split pt.
- Use in work hardening grades of stainless steel and other hard metal drilling applications.

Type 130-AGX

1/2" Reduced Shank
Premium, Silver & Deming
3-Flats on Shank
118° Split Point

- M2 High speed steel.
- Precision ground point, flutes, body and clearance.
- 118° split point for superior general purpose drilling in metal, wood and plastic.



Type 130-CN

CN-TECH™ CRYO/NITRIDE

1/2" Reduced Shank 135° Split Point

- Nitride coating creates a case hardened surface that is resistant to rust, heat and extends tool life.
- Excellent for truck & trailer repair, and all MRO applications.



Type 130-CN

Nitride process case hardening resulting in superior tool life and exceptional corrosion resistance.

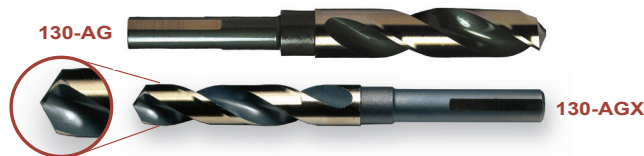

130-AG Part#	130-AGX Part#	Diameter Inches	Overall Length Inches	Qty. per/pack
29550	74001	33/64	6	1
29560	74011	17/32	6	1
29570	74021	35/64	6	1
29580	74031	9/16	6	1
29590	74041	37/64	6	1
29600	74051	19/32	6	1
29610	74061	39/64	6	1
29620	74071	5/8"	6	1
29630	74081	41/64	6	1
29640	74091	21/32	6	1
29650	74101	43/64	6	1
29660	74111	11/16	6	1
29670	74121	45/64	6	1
29680	74131	23/32	6	1
29690	74141	47/64	6	1
29700	74151	3/4"	6	1
29710	74161	49/64	6	1
29720	74171	25/32	6	1
29730	74181	51/64	6	1
29740	74191	13/16	6	1
29750	74201	53/64	6	1
29760	74211	27/32	6	1
29770	74221	55/64	6	1
29780	74231	7/8"	6	1
29790	74241	57/64	6	1
29800	74251	29/32	6	1
29810	74261	59/64	6	1
29820	74271	15/16	6	1
29830	74281	61/64	6	1
29840	74291	31/32	6	1
29850	74301	63/64	6	1
29860	74311	1"	6	1
29870	----	1-1/32	6	1
29880	74321	1-1/16	6	1
29890	----	1-3/32	6	1
29900	74331	1-1/8	6	1
29910	74341	1-5/32	6	1
29920	74351	1-3/16	6	1
29930	----	1-7/32	6	1
29940	74361	1-1/4	6	1
29950	----	1-5/16	6	1
29960	----	1-3/8	6	1
29970	----	1-7/16	6	1
29980	----	1-1/2	6	1

Sets

Part #	9/16, 5/8, 3/4, 1"	Qty of ea.
12250 S&D-4SP	1/2" Shank - Silver & Deming	1
74771 S&D-4AGX	1/2" Shank - Silver & Deming	1

8 Pc.

Part #	9/16" - 1" by 16ths	Qty of ea.
92400 S&D-8SP	1/2" Shank - Silver & Deming	1
74781 S&D-8AGX	1/2" Shank - Silver & Deming	1

FRACTIONAL

Part #	Diameter Inches	Overall Length Inches	Qty. per/pack
30003	33/64"	6	1
30013	17/32	6	1
30023	35/64	6	1
30033	9/16"	6	1
30043	37/64	6	1
30053	19/32	6	1
30063	39/64	6	1
30073	5/8"	6	1
30083	41/64	6	1
30093	21/32	6	1
30103	43/64	6	1
30113	11/16	6	1
30123	45/64	6	1
30133	23/32	6	1
30143	47/64	6	1
30153	3/4"	6	1
30163	49/64	6	1
30173	25/32	6	1
30183	51/64	6	1
30193	13/16	6	1
30203	53/64	6	1
30213	27/32	6	1
30223	55/64	6	1
30233	7/8"	6	1
30243	57/64	6	1
30253	29/32	6	1
30263	59/64	6	1
30273	15/16	6	1
30283	61/64	6	1
30293	31/32	6	1
30303	63/64	6	1
30313	1"	6	1

Sets

Part #	4 Pc. 9/16, 5/8, 3/4, 1"	Qty of ea.
30323 S&D-4CN	CN-TECH™ CRYO/NITRIDE 1/2" Shank - Silver & Deming	1

Part #	8 Pc. 9/16 - 1" by 16ths	Qty of ea.
30333 S&D-8CN	CN-TECH™ CRYO/NITRIDE 1/2" Shank - Silver & Deming	1

Part #	13 Pc. 3 ea.(9/16" & 5/8") 2 ea.(3/4") 11/16", 13/16", 7/8", 15/16", 1"	Qty of ea.
30343 S&D-13CN	CN-TECH™ CRYO/NITRIDE 1/2" Shank - Silver & Deming	1

Part #	33 Pc. 1/2 - 1" by 64ths	Qty of ea.
30353 S&D-33CN	CN-TECH™ CRYO/NITRIDE 1/2" Shank - Silver & Deming	1

Reduced Shank

VORTEX-POINT™, METRIC-1/2" & 3/4" REDUCED SHANK SILVER & DEMING

Type 130-AGM - METRIC

1/2" Reduced Shank Silver & Deming
135° Split Point, 3-Flats on Shank

- Special Hi-Molybdenum tool steel.
- One-piece solid construction
- Body and clearance are gold surface treated for maximum lubricity.
- **Recommended** for use in work hardening grades of stainless steel and other hard metal drilling applications.



METRIC

Part #	Dia. MM	OAL Inches	Part #	Dia. MM	OAL Inches
25500	14.0	6	25520	20.0	6
25501	14.5	6	25521	20.5	6
25502	15.0	6	25522	21.0	6
25541	15.5	6	25523	21.5	6
25504	16.0	6	25524	22.0	6
25542	16.5	6	25529	22.5	6
25510	17.0	6	25530	23.0	6
25511	17.5	6	25531	23.5	6
25512	18.0	6	25532	24.0	6
25543	18.5	6	25549	24.5	6
25514	19.0	6	25534	25.0	6
25544	19.5	6			

Qty. per package 1

Qty. per package 1

Type 130-VT

VORTEX-POINT™

NEW

1/2" Shank Silver & Deming
135° Split point - 3-Flats on Shank

- Unique tip geometry reduces heat generation & cutting tool wear increasing tool life.
- Easily enlarges existing holes without damaging the point.
- Stay sharp up to 4X longer compared to conventional and other specialty tip design.
- **Recommended** for Cast iron, Brass, Sheet metal, Plastic, Mild steel, Copper, Hardened steel.



Part #	Diameter Inches	Overall Length Inches	Qty. per/pack
26033	9/16"	6	1
26073	5/8"	6	1
26113	11/16	6	1
26153	3/4"	6	1
26193	13/16	6	1
26233	7/8"	6	1
26273	15/16	6	1
26313	1"	6	1

Sets

4 Pc.

Part #	Diameter	Overall Length	Qty. of ea.
26443 S&D-4VT	9/16, 5/8, 3/4, 1"	VORTEX-POINT™	1
	1/2" Shank - Silver & Deming		

8 Pc.

Part #	Diameter	Overall Length	Qty. of ea.
26473 S&D-8VT	9/16 - 1" by 16ths	VORTEX-POINT™	1
	1/2" Shank - Silver & Deming		

Type 130

1/2" Reduced Shank Silver & Deming
118° point - General Purpose

- This general purpose 118° point high-speed steel drill is recommended for use in drilling equipment with 1/2" chucks.
- Type 130 drills may be used in power applications such as drill presses where a short rigid drill is required.



Part #	Diameter Inches	Overall Length Inches	Qty. per/pack
29130	33/64"	6	1
29140	17/32	6	1
29150	35/64	6	1
29160	9/16"	6	1
29170	37/64	6	1
29180	19/32	6	1
29190	39/64	6	1
29200	5/8"	6	1
29210	41/64	6	1
29220	21/32	6	1
29230	43/64	6	1
29240	11/16	6	1
29250	45/64	6	1
29260	23/32	6	1
29270	47/64	6	1
29280	3/4"	6	1
29290	49/64	6	1
29300	25/32	6	1
29310	51/64	6	1
29320	13/16	6	1
29330	53/64	6	1
29340	27/32	6	1
29350	55/64	6	1
29360	7/8"	6	1
29370	57/64	6	1
29380	29/32	6	1
29390	59/64	6	1
29400	15/16	6	1
29410	61/64	6	1
29420	31/32	6	1
29430	63/64	6	1
29440	1"	6	1
29450	1-1/16	6	1
29460	1-1/8	6	1
29470	1-5/32	6	1
29480	1-3/16	6	1
29490	1-1/4	6	1
29540	1-47/64	6	1

Type 131-AG

3/4" Reduced Shank Silver & Deming
Magnum Super Premium - 135° Split Point

- These are high performance, close tolerance, tight run out spec.
- Tools designed for drilling with Bridgeport style or other production machines with 3/4" chucks.
- Recommended for use in work hardening grades of stainless steel and other hard metal drilling applications.



Part #	Diameter Inches	Flute Length Inches	Overall Length Inches	Qty. per/pack
29741	13/16	3-1/4	5-1/2	1
29781	7/8	3-1/4	5-1/2	1
29821	15/16	3-1/4	5-1/2	1
29861	1	3-1/4	5-1/2	1
29901	1-1/8	3-1/2	5-27/32	1
29941	1-1/4	3-1/2	5-7/8	1
29961	1-3/8	3-1/2	5-29/32	1
29981	1-1/2	3-1/2	5-15/16	1

SILVER & DEMING - 1/2" REDUCED SHANK

Type 130-MRO

Maintenance Length - 1/2" Reduced Shank
135° Split Point 3-Flats on Shank
Surface Treated Flutes

- The 130-MRO is a shorter (5") tougher version of our very popular 1/2" reduced shank product.
- Designed specifically for the needs of the **MRO market**, the 130-MRO has a 135° split point to insure fast hole starts without drill walking.
- The three flats on the shank insure positive chucking with out slippage.



FRACTIONAL

Part #	Size / Inches	Overall Length	Qty. per/pack
54291	33/64"	5	1
54300	17/32	5	1
54301	35/64	5	1
54310	9/16	5	1
54311	37/64	5	1
54320	19/32	5	1
54321	39/64	5	1
54330	5/8"	5	1
54331	41/64	5	1
54340	21/32	5	1
54341	43/64	5	1
54350	11/16	5	1
54351	45/64	5	1
54360	23/32	5	1
54361	47/64	5	1
54370	3/4"	5	1
54371	49/64	5	1
54380	25/32	5	1
54381	51/64	5	1
54390	13/16	5	1
54391	53/64	5	1
54400	27/32	5	1
54401	55/64	5	1
54410	7/8"	5	1
54411	57/64	5	1
54420	29/32	5	1
54421	59/64	5	1
54430	15/16	5	1
54431	61/64	5	1
54440	31/32	5	1
54441	63/64	5	1
54450	1"	5	1

SET - Type 130-MRO

4 Pc.
9/16, 5/8, 3/4, 1"

Part #	Qty of each
54520 S&D-4	1/2" Shank-Silver & Deming 1

Type 130-D

1/2" Reduced Shank Silver & Deming
Super High-Speed M42 Cobalt

- Heavy-duty 135° split point with gold finish for use in drilling hard tough metals, free machining stainless steel, high temperature alloys, titanium and certain plastics.
- High red hot hardness of cobalt steel permits speeds **30% higher than regular high speed steel drills.**
- Cobalt drills require rigidly held, positive feed drilling equipment.



Part #	Diameter Inches	Overall Length Inches	Qty. per/pack
29131	33/64	6	1
29141	17/32	6	1
29151	35/64	6	1
29161	9/16	6	1
29171	37/64	6	1
29181	19/32	6	1
29191	39/64	6	1
29201	5/8	6	1
29211	41/64	6	1
29221	21/32	6	1
29231	43/64	6	1
29241	11/16	6	1
29251	45/64	6	1
29261	23/32	6	1
29271	47/64	6	1
29281	3/4	6	1
29291	49/64	6	1
29331	25/32	6	1
29311	51/64	6	1
29321	13/16	6	1
29301	53/64	6	1
29341	27/32	6	1
29351	55/64	6	1
29361	7/8	6	1
29371	57/64	6	1
29381	29/32	6	1
29391	59/64	6	1
29401	15/16	6	1
29411	61/64	6	1
29421	31/32	6	1
29431	63/64	6	1
29441	1"	6	1

SETS Type 130-D

4 Pc.

Part #	9/16, 5/8, 3/4, 1"	Qty of each
29551 S&D-4D	M42 Cobalt 135° Split point	1

8 Pc.

Part #	9/16 - 1" by 16ths	Qty of each
29571 S&D-8D	M42 Cobalt 135° Split point	1

Type EXT

Silver and Deming - Extension

Includes an "Allen Wrench"



Part #	Bore/Shank Diameter	Overall Length	Extension Length	Qty. per/pack
62730	1/2" 7/8"	7-1/2"	6"	1

Silver & Deming - 1/2" Reduced Shank Cobalt / Maintenance Length

Taper Shank

HSS TAPER SHANK - REGULAR

Type 510

High-Speed Steel 118° Point Taper Shank
Regular Shank - Black Oxide Flutes & Clearance

- Taper shank drills are made to fit tapered holders.
- Precision ground flutes, clearance and point.
- Designed to perform well under a wide variety of conditions in a wide range of materials.
- Made in the U.S.A.



FRACTIONAL

Part #	Diameter Inches	Decimal Equivalent Inches	Taper Shank	Overall Length Inches	Flute Length Inches
14150	1/8	.1250	1	5-1/8	1-7/8
14160	9/64	.1406	1	5-3/8	2-1/8
14170	5/32	.1562	1	5-3/8	2-1/8
14180	11/64	.1719	1	5-3/4	2-1/2
14190	3/16	.1875	1	5-3/4	2-1/2
14200	13/64	.2031	1	6	2-3/4
14210	7/32	.2188	1	6	2-3/4
14220	15/64	.2344	1	6-1/8	2-7/8
14230	1/4	.2500	1	6-1/8	2-7/8
14240	17/64	.2656	1	6-1/4	3
14250	9/32	.2812	1	6-1/4	3
14260	19/64	.2969	1	6-3/8	3-1/8
14270	5/16	.3125	1	6-3/8	3-1/8
14280	21/64	.3281	1	6-1/2	3-1/4
14290	11/32	.3438	1	6-1/2	3-1/4
14300	23/64	.3594	1	6-3/4	3-1/2
14310	3/8	.3750	1	6-3/4	3-1/2
14320	25/64	.3906	1	7	3-5/8
14330	13/32	.4062	1	7	3-5/8
14340	27/64	.4219	1	7-1/4	3-7/8
14350	7/16	.4375	1	7-1/4	3-7/8
14360	29/64	.4531	1	7-1/2	4-1/8
14370	15/32	.4688	1	7-1/2	4-1/8
14380	31/64	.4844	2	8-1/4	4-3/8
14390	1/2	.5000	2	8-1/4	4-3/8
14400	33/64	.5156	2	8-1/2	4-5/8
14410	17/32	.5312	2	8-1/2	4-5/8
14420	35/64	.5469	2	8-3/4	4-7/8
14430	9/16	.5625	2	8-3/4	4-7/8
14440	37/64	.5781	2	8-3/4	4-7/8
14450	19/32	.5938	2	8-3/4	4-7/8
14460	39/64	.6094	2	8-3/4	4-7/8
14470	5/8	.6250	2	8-3/4	4-7/8
14480	41/64	.6406	2	9	5-1/8
14490	21/32	.6562	2	9	5-1/8
14500	43/64	.6719	2	9-1/4	5-3/8
14510	11/16	.6875	2	9-1/4	5-3/8
14520	45/64	.7031	2	9-1/2	5-5/8
14530	23/32	.7188	2	9-1/2	5-5/8
14540	47/64	.7344	2	9-3/4	5-7/8
14550	3/4	.7500	2	9-3/4	5-7/8
14560	49/64	.7656	2	9-7/8	6
14570	25/32	.7812	2	9-7/8	6
14580	51/64	.7969	3	10-3/4	6-1/8
14590	13/16	.8125	3	10-3/4	6-1/8
14600	53/64	.8281	3	10-3/4	6-1/8
14610	27/32	.8438	3	10-3/4	6-1/8
14620	55/64	.8594	3	10-3/4	6-1/8
14630	7/8	.8750	3	10-3/4	6-1/8
14640	57/64	.8906	3	10-3/4	6-1/8
14650	29/32	.9062	3	10-3/4	6-1/8
14660	59/64	.9219	3	10-3/4	6-1/8
14670	15/16	.9375	3	10-3/4	6-1/8
14680	61/64	.9531	3	11	6-3/8
14690	31/32	.9688	3	11	6-3/8
14700	63/64	.9844	3	11	6-3/8
14710	1"	1.0000	3	11	6-3/8

FRACTIONAL

Part #	Diameter Inches	Decimal Equivalent Inches	Taper Shank	Overall Length Inches	Flute Length Inches
14730	1-1/32	1.0312	3	11-1/8	6-1/2
14740	1-3/64	1.0469	3	11-1/4	6-5/8
14750	1-1/16	1.0625	3	11-1/4	6-5/8
14760	1-5/64	1.0781	4	12-1/2	6-7/8
14770	1-3/32	1.0938	4	12-1/2	6-7/8
14780	1-7/64	1.1094	4	12-3/4	7-1/8
14790	1-1/8	1.1250	4	12-3/4	7-1/8
14800	1-9/64	1.1406	4	12-7/8	7-1/4
14810	1-5/32	1.1562	4	12-7/8	7-1/4
14820	1-11/64	1.1719	4	13	7-3/8
14830	1-3/16	1.1875	4	13	7-3/8
14840	1-13/64	1.2031	4	13-1/8	7-1/2
14850	1-7/32	1.2188	4	13-1/8	7-1/2
14860	1-15/64	1.2344	4	13-1/2	7-7/8
14870	1-1/4	1.2500	4	13-1/2	7-7/8
14880	1-17/64	1.2656	4	14-1/8	8-1/2
14890	1-9/32	1.2812	4	14-1/8	8-1/2
14900	1-19/64	1.2969	4	14-1/4	8-5/8
14910	1-5/16	1.3125	4	14-1/4	8-5/8
14920	1-21/64	1.3281	4	14-3/8	8-3/4
14930	1-11/32	1.3438	4	14-3/8	8-3/4
14940	1-23/64	1.3594	4	14-1/2	8-7/8
14950	1-3/8	1.3750	4	14-1/2	8-7/8
14960	1-25/64	1.3906	4	14-5/8	9
14970	1-13/32	1.4062	4	14-5/8	9
14980	1-27/64	1.4219	4	14-3/4	9-1/8
14990	1-7/16	1.4375	4	14-3/4	9-1/8
15000	1-29/64	1.4531	4	14-7/8	9-1/4
15010	1-15/32	1.4688	4	14-7/8	9-1/4
15020	1-31/64	1.4844	4	15	9-3/8
15030	1-1/2	1.5000	4	15	9-3/8
15040	1-17/32	1.5312	5	16-3/8	9-3/8
15050	1-9/16	1.5625	5	16-5/8	9-5/8
15060	1-19/32	1.5938	5	16-7/8	9-7/8
15070	1-5/8	1.6250	5	17	10
15080	1-21/32	1.6562	5	17-1/8	10-1/8
15090	1-11/16	1.6875	5	17-1/8	10-1/8
15100	1-23/32	1.7188	5	17-1/8	10-1/8
15110	1-3/4	1.7500	5	17-1/8	10-1/8
15120	1-25/32	1.7812	5	17-1/8	10-1/8
15130	1-13/16	1.8125	5	17-1/8	10-1/8
15140	1-27/32	1.8438	5	17-1/8	10-1/8
15150	1-7/8	1.8750	5	17-3/8	10-3/8
15160	1-29/32	1.9062	5	17-3/8	10-3/8
15170	1-15/16	1.9375	5	17-3/8	10-3/8
15180	1-31/32	1.9688	5	17-3/8	10-3/8
15190	2"	2.0000	5	17-3/8	10-3/8
15200	2-1/32	2.0312	5	17-3/8	10-3/8
15210	2-1/16	2.0625	5	17-3/8	10-1/4
15220	2-3/32	2.0938	5	17-3/8	10-1/4
15230	2-1/8	2.1250	5	17-3/8	10-1/4
15240	2-5/32	2.1562	5	17-3/8	10-1/4
15250	2-3/16	2.1875	5	17-3/8	10-1/4
15260	2-7/32	2.2188	5	17-3/8	10-1/8
15270	2-1/4	2.2500	5	17-3/8	10-1/8
15280	2-5/16	2.3125	5	17-3/8	10-1/8
15290	2-3/8	2.3750	5	17-3/8	10-1/8
15300	2-7/16	2.4375	5	18-3/4	11-1/4
15310	2-1/2	2.5000	5	18-3/4	11-1/4

Letter sizes continued on page 49

Taper Shank

HSS TAPER SHANK - REGULAR

Type 500

High-Speed Steel Taper Shank
Shank Smaller than Regular - Black Oxide

- Taper shank drills are made to fit tapered holders.
- They are designed to perform well under a variety of normal conditions in a wide range of materials.
- Packaged individually.



FRACTIONAL

Part #	Diameter Inches	Decimal Equivalent Inches	Taper Shank	Overall Length Inches	Flute Length Inches
16050	31/64	.4844	1	7-3/4	4-3/8
16060	1/2"	.5000	1	7-3/4	4-3/8
16070	33/64	.5156	1	8	4-5/8
16080	17/32	.5312	1	8	4-5/8
16090	35/64	.5469	1	8-1/4	4-7/8
16100	9/16"	.5625	1	8-1/4	4-7/8
16110	51/64	.7969	2	10	6-1/8
16120	13/16	.8125	2	10	6-1/8
16130	53/64	.8281	2	10	6-1/8
16140	27/32	.8438	2	10	6-1/8
16150	55/64	.8594	2	10	6-1/8
16160	7/8"	.8750	2	10	6-1/8
16170	57/64	.8906	2	10	6-1/8
16180	29/32	.9062	2	10	6-1/8
16190	1-5/64	1.0781	3	11-1/2	6-7/8
16200	1-3/32	1.0938	3	11-1/2	6-7/8
16210	1-7/64	1.1094	3	11-3/4	7-1/8
16220	1-1/8	1.1250	3	11-3/4	7-1/8
16230	1-9/64	1.1406	3	11-7/8	7-1/4
16240	1-5/32	1.1562	3	11-7/8	7-1/4
16250	1-11/64	1.1719	3	12	7-3/8
16260	1-3/16	1.1875	3	12	7-3/8
16270	1-13/64	1.2031	3	12-1/8	7-1/2
16280	1-7/32	1.2188	3	12-1/8	7-1/2
16290	1-15/64	1.2344	3	12-1/2	7-7/8
16300	1-1/4	1.2500	3	12-1/2	7-7/8
16320	1-17/32	1.5312	4	15	9-3/8
16340	1-9/16	1.5625	4	15-1/4	9-5/8
16360	1-19/32	1.5938	4	15-1/2	9-7/8
16380	1-5/8	1.6250	4	15-5/8	10
16400	1-21/32	1.6562	4	15-3/4	10-1/8
16420	1-11/16	1.6875	4	15-3/4	10-1/8
16440	1-23/32	1.7188	4	15-3/4	10-1/8
16460	1-3/4	1.7500	4	16-1/4	10-3/8
16470	1-25/32	1.7812	4	16-1/4	10-3/8
16480	1-13/16	1.8125	4	16-1/4	10-3/8
16490	1-27/32	1.8438	4	16-1/4	10-3/8
16500	1-7/8	1.8750	4	16-1/2	10-1/2
16510	1-29/32	1.9062	4	16-1/2	10-1/2
16520	1-15/16	1.9375	4	16-5/8	10-5/8
16530	1-31/32	1.9688	4	16-5/8	10-5/8
16540	2"	2.0000	4	16-5/8	10-5/8

Type 510 - Continued

High-Speed Steel Taper Shank Regular Shank - Black Oxide

LETTER

Part #	Letter Size	Decimal Equivalent Inches	Taper Shank	Overall Length Inches	Flute Length Inches
15700	A	.234	1	6-1/8	2-7/8
15710	B	.238	1	6-1/8	2-7/8
15720	C	.242	1	6-1/8	2-7/8
15730	D	.246	1	6-1/8	2-7/8
15740	E	.250	1	6-1/8	2-7/8
15750	F	.257	1	6-1/4	3
15760	G	.261	1	6-1/4	3
15770	H	.266	1	6-1/4	3
15780	I	.272	1	6-1/4	3
15790	J	.277	1	6-1/4	3
15800	K	.281	1	6-1/4	3
15810	L	.290	1	6-3/8	3-1/8
15820	M	.295	1	6-3/8	3-1/8
15830	N	.302	1	6-3/8	3-1/8
15840	O	.316	1	6-1/2	3-1/4
15850	P	.323	1	6-1/2	3-1/4
15860	Q	.332	1	6-1/2	3-1/4
15870	R	.339	1	6-1/2	3-1/4
15880	S	.348	1	6-3/4	3-1/2
15890	T	.358	1	6-3/4	3-1/2
15900	U	.368	1	6-3/4	3-1/2
15910	V	.377	1	7	3-5/8
15920	W	.386	1	7	3-5/8
15930	X	.397	1	7	3-5/8
15940	Y	.404	1	7	3-5/8
15950	Z	.413	1	7-1/4	3-7/8

Type 520

High-Speed Steel Taper Shank
Shank Larger than Regular - Black Oxide

- Taper shank drills are made to fit tapered holders.
- They are designed to perform well under a variety of normal conditions in a wide range of materials.
- Packaged individually.



FRACTIONAL

Part#	Diameter Inches	Decimal Equivalent Inches	Taper Shank	Overall Length Inches	Flute Length Inches
15450	3/8	.3750	2	7-3/8	3-1/2
15460	25/64	.3906	2	7-1/2	3-5/8
15470	13/32	.4062	2	7-1/2	3-5/8
15480	27/64	.4219	2	7-3/4	3-7/8
15490	7/16	.4375	2	7-3/4	3-7/8
15500	29/64	.4531	2	8	4-1/8
15510	15/32	.4688	2	8	4-1/8
15520	41/64	.6406	3	9-3/4	5-1/8
15530	21/32	.6262	3	9-3/4	5-1/8
15540	43/64	.6719	3	10	5-3/8
15550	11/16	.6875	3	10	5-3/8
15560	45/64	.7031	3	10-1/4	5-5/8
15570	23/32	.7188	3	10-1/4	5-5/8
15580	47/64	.7344	3	10-1/2	5-7/8
15590	3/4	.7500	3	10-1/2	5-7/8
15600	49/64	.7656	3	10-5/8	6
15610	25/32	.7812	3	10-5/8	6
15620	1"	1.0000	4	12	6-3/8
15630	1-1/32	1.0312	4	12-1/8	6-1/2
15640	1-1/16	1.0625	4	12-1/4	6-5/8

HSS Taper Shank - Smaller than Regular & Larger than Regular

Jobber Blank

DRILL BLANK

Type 240-DB

Jobbers Length

Hardened and Ground - Bright Finish

• Fully hardened drill blanks typically used as hole size and bushing gauges.

• May also be used as guide pins for die sets.

Tolerances: +.0000 -.0005 thru 1/4" +.0000 -.0007 over 1/4"

FRACTIONAL

Part #	Diameter Inches	Overall Length Inches	Qty. per/pack
02769	1/32	1-3/8	12
02779	3/64	1-3/4	12
02789	1/16	1-7/8	12
02799	5/64	2	12
02809	3/32	2-1/4	12
02819	7/64	2-5/8	12
02829	1/8	2-3/4	12
02839	9/64	2-7/8	12
02849	5/32	3-1/8	12
02859	11/64	3-1/4	12
02869	3/16	3-1/2	12
02879	13/64	3-5/8	12
02889	7/32	3-3/4	12
02899	15/64	3-7/8	12
02909	1/4	4	12
16919	17/64	4-1/8	12
16929	9/32	4-1/4	12
16939	19/64	4-3/8	6
16949	5/16	4-1/2	6
16959	21/64	4-5/8	6
16969	11/32	4-3/4	6
16979	23/64	4-7/8	6
16989	3/8	5	6
16999	25/64	5-1/8	6
17009	13/32	5-1/4	6
17019	27/64	5-3/8	6
17029	7/16	5-1/2	6
17039	29/64	5-5/8	6
17049	15/32	5-3/4	6
17059	31/64	5-7/8	6
17069	1/2	6	6

LETTER

Part #	Letter Sizes	Qty. per/pack
02419	A	12
02429	B	12
02439	C	12
02449	D	12
02459	E	12
02469	F	12
02479	G	12
02489	H	12
02499	I	12
02509	J	12
02519	K	12
02529	L	12
02539	M	6
02549	N	6
02559	O	6
02569	P	6
02579	Q	6
02589	R	6
02599	S	6
02609	T	6
02619	U	6
02629	V	6
02639	W	6
02649	X	6
02659	Y	6
26960	Z	6

WIRE

Part #	Wire Sizes	Overall Length Inches	Qty. per/pack
03199	1	3-7/8	12
03209	2	3-7/8	12
03219	3	3-3/4	12
03229	4	3-3/4	12
03239	5	3-3/4	12
03249	6	3-3/4	12
03259	7	3-5/8	12
03269	8	3-5/8	12
03279	9	3-5/8	12
03289	10	3-5/8	12
03299	11	3-1/2	12
03309	12	3-1/2	12
03319	13	3-1/2	12
03329	14	3-3/8	12
03339	15	3-3/8	12
03349	16	3-3/8	12
03359	17	3-3/8	12
03369	18	3-1/4	12
03379	19	3-1/4	12
03389	20	3-1/4	12
03399	21	3-1/4	12
03409	22	3-1/8	12
03419	23	3-1/8	12
03429	24	3-1/8	12
03439	25	3"	12
03449	26	3"	12
03459	27	3"	12
03469	28	2-7/8	12
03479	29	2-7/8	12
03489	30	2-3/4	12
03499	31	2-3/4	12
03509	32	2-3/4	12
03519	33	2-5/8	12
03529	34	2-5/8	12
03539	35	2-5/8	12
03549	36	2-1/2	12
03559	37	2-1/2	12
03569	38	2-1/2	12
03579	39	2-3/8	12
03589	40	2-3/8	12
03599	41	2-3/8	12
03609	42	2-1/4	12
03619	43	2-1/4	12
03629	44	2-1/8	12
03639	45	2-1/8	12
03649	46	2-1/8	12
03659	47	2"	12
03669	48	2"	12
03679	49	2"	12
03689	50	2"	12
03699	51	2"	12
03709	52	1-7/8	12
03719	53	1-7/8	12
03729	54	1-7/8	12
03739	55	1-7/8	12
03749	56	1-3/4	12
03759	57	1-3/4	12
03769	58	1-5/8	12
03779	59	1-5/8	12
03789	60	1-5/8	12
03799	61	1-5/8	12
03809	62	1-1/2	12
03819	63	1-1/2	12
03829	64	1-1/2	12
03839	65	1-1/2	12
03849	66	1-3/8	12
03859	67	1-3/8	12
03869	68	1-3/8	12
03879	69	1-3/8	12
03889	70	1-1/4	12
03899	71	1-1/4	12
03919	72	1-1/8	12
03929	73	1-1/8	12
03939	74	1"	12
03949	75	1"	12
03959	76	7/8	12
03969	77	7/8	12
03979	78	7/8	12
03989	79	3/4	12
03999	80	3/4	12

Decimal Equivalent & Tap Drill Sizes Chart

Drill Size	Decimal	Drill Size	Decimal	Drill Size	Decimal	Drill Size	Decimal	Drill Size	Decimal
0.10	.0039	54	.0550	26	.1470	17/64	.2656	11.50	.4528
97	.0059	1.40	.0551	25	.1495	H	.2660	29/64	.4531
96	.0063	1.45	.0571	3.80	.1496	6.80	.2677	11.80	.4646
95	.0067	1.50	.0591	24	.1520	6.90	.2717	15/32	.4688
94	.0071	53	.0595	3.90	.1535	I	.2720	12.00	.4724
93	.0075	1.55	.0610	23	.1540	7.00	.2756	12.20	.4803
92	.0079	1/16	.0625	5/32	.1562	J	.2770	31/64	.4844
0.20	.0079	1.60	.0630	22	.1570	7.10	.2795	12.50	.4921
91	.0083	52	.0635	4.00	.1575	K	.2810	1/2	.5000
90	.0087	1.65	.0650	21	.1590	9/32	.2812	13.00	.5118
89	.0091	1.70	.0669	20	.1610	7.20	.2835	33/64	.5156
88	.0095	51	.0670	4.10	.1614	7.30	.2874	17/32	.5312
87	.0100	1.75	.0689	4.20	.1654	L	.2900	13.50	.5315
86	.0105	50	.0700	19	.1660	7.40	.2913	35/64	.5469
85	.0110	1.80	.0709	4.30	.1693	M	.2950	14.00	.5512
84	.0115	1.85	.0728	18	.1695	7.50	.2953	9/16	.5625
0.30	.0118	49	.0730	11/64	.1719	19/64	.2969	14.50	.5709
83	.0120	1.90	.0748	17	.1730	7.60	.2992	37/64	.5781
82	.0125	48	.0760	4.40	.1732	N	.3020	15.00	.5906
81	.0130	1.95	.0768	16	.1770	7.70	.3031	19/32	.5938
80	.0135	5/64	.0781	4.50	.1772	7.80	.3071	39/64	.6094
0.35	.0138	47	.0785	15	.1800	7.90	.3110	15.50	.6102
79	.0145	2.00	.0787	4.60	.1811	5/16	.3125	5/8	.6250
1/64	.0156	2.05	.0807	14	.1820	8.00	.3150	16.00	.6299
0.40	.0157	46	.0810	13	.1850	O	.3160	41/64	.6406
78	.0160	45	.0820	4.70	.1850	8.10	.3189	16.50	.6496
0.45	.0177	2.10	.0827	3/16	.1875	8.20	.3228	21/32	.6562
77	.0180	2.15	.0846	12	.1890	P	.3230	17.00	.6693
0.50	.0197	44	.0860	4.80	.1890	8.30	.3268	43/64	.6719
76	.0200	2.20	.0866	11	.1910	21/64	.3281	11/16	.6875
75	.0210	2.25	.0886	4.90	.1929	8.40	.3307	17.50	.6890
0.55	.0217	43	.0890	10	.1935	Q	.3320	45/64	.7031
74	.0225	2.30	.0906	9	.1960	8.50	.3346	18.00	.7087
0.60	.0236	2.35	.0925	5.00	.1969	8.60	.3386	23/32	.7188
73	.0240	42	.0935	8	.1990	R	.3390	18.50	.7283
72	.0250	3/32	.0938	5.10	.2008	8.70	.3425	47/64	.7344
0.65	.0256	2.40	.0945	7	.2010	11/32	.3438	19.00	.7480
71	.0260	41	.0960	13/64	.2031	8.80	.3465	3/4	.7500
0.70	.0276	2.45	.0965	6	.2040	S	.3480	49/64	.7656
70	.0280	40	.0980	5.20	.2047	8.90	.3504	19.50	.7677
69	.0292	2.50	.0984	5	.2055	9.00	.3543	25/32	.7812
0.75	.0295	39	.0995	5.30	.2087	T	.3580	20.00	.7874
68	.0310	38	.1015	4	.2090	9.10	.3583	51/64	.7969
1/32	.0312	2.60	.1024	5.40	.2126	23/64	.3594	20.50	.8071
0.80	.0315	37	.1040	3	.2130	9.20	.3622	13/16	.8125
67	.0320	2.70	.1063	5.50	.2165	9.30	.3661	21.00	.8268
66	.0330	36	.1065	7/32	.2188	U	.3680	53/64	.8281
0.85	.0335	7/64	.1094	5.60	.2205	9.40	.3701	27/32	.8438
65	.0350	35	.1100	2	.2210	9.50	.3740	21.50	.8465
0.90	.0354	2.80	.1102	5.70	.2244	3/8	.3750	55/64	.8594
64	.0360	34	.1110	1	.2280	V	.3770	22.00	.8661
63	.0370	33	.1130	5.80	.2283	9.60	.3780	7/8	.8750
0.95	.0374	2.90	.1142	5.90	.2323	9.70	.3819	22.50	.8858
62	.0380	32	.1160	A	.2340	9.80	.3858	57/64	.8906
61	.0390	3.00	.1181	15/64	.2344	W	.3860	23.00	.9055
1.00	.0394	31	.1200	6.00	.2362	9.90	.3898	29/32	.9062
60	.0400	3.10	.1220	B	.2380	25/64	.3906	59/64	.9219
59	.0410	1/8	.1250	6.10	.2402	10.00	.3937	23.50	.9252
1.05	.0413	3.20	.1260	C	.2420	X	.3970	15/16	.9375
58	.0420	3.25	.1280	6.20	.2441	10.20	.4016	24.00	.9449
57	.0430	30	.1285	D	.2460	Y	.4040	61/64	.9531
1.10	.0433	3.30	.1299	6.30	.2480	10.30	.4058	24.50	.9646
1.15	.0453	3.40	.1339	1/4	.2500	13/32	.4062	31/32	.9688
56	.0465	29	.1360	E	.2500	Z	.4130	25.00	.9843
3/64	.0469	3.50	.1378	6.40	.2520	10.50	.4134	63/64	.9844
1.20	.0472	28	.1405	6.50	.2559	27/64	.4219	1"	1.0000
1.25	.0492	9/64	.1406	F	.2570	10.80	.4252		
1.30	.0512	3.60	.1417	6.60	.2598	11.00	.4331		
55	.0520	27	.1440	G	.2610	7/16	.4375		
1.35	.0531	3.70	.1457	6.70	.2638	11.20	.4409		

TAP DRILL SIZES

Thread	Drill	Thread	Drill	Thread	Drill	Thread	Drill
0-80	3/64	M3.0-.5	2.50M	12-28	14	7/16-20	25/64
M1.6-.35	1.25M	5-40	38	M6.0-1	5.0M	M12-1.75	Y
1-64	54	5-44	37	1/4-20	7	1/2-13	27/64
M1.8-.35	1.45M	6-32	36	1/4-28	3	M12-1.25	10.8M
1-72	53	6-40	33	M7.0-1	6.0M	1/2-20	29/64
M2.0-.4	1.60M	M3.5-.6	2.90M	5/16-18	F	M14-2	12.0M
2-56	51	M4.0-.7	3.30M	M8.0-1.25	H	9/16-12	31/64
M2.2-.45	1.75M	8-32	29	5/16-24	I	M14-1.5	12.5M
2-64	50	8-36	29	M8.0-1	7.0M	9/16-18	33/64
3-48	47	M4.5-.75	26	3/8-16	5/16	M16-2	14.0M
M2.5-.45	2.05M	10-24	25	3/8-24	Q	5/8-11	17/32
3-56	45	10-32	21	M10-1.5	8.5M	M16-1.5	14.5M
4-40	43	M5.0-.8	4.20M	M10-1.25	11/32	5/8-18	37/64
4-48	42	12-24	16	7/16-14	U	M18-2.5	15.5M
						M18-1.5	16.5M
						3/4-10	21/32
						3/4-16	11/16
						M20-2.5	17.5M
						M20-1.5	18.5M
						7/8-9	49/64
						M22-2.5	19.5M
						M22-1.5	20.5M
						7/8-14	13/16
						M24-3	21.0M
						M24-2	22.0M
						1-8	7/8
						1-12	59/64
						1-14	15/16

Technical Reference - Decimal Equivalent

Drill Feed & Speeds

Different drilling conditions make it impossible to develop any rigid rules for feeds and speeds. The following tables contain guidelines which can be utilized when drilling standard materials. Also, the following "rules of thumb" can be used to determine proper feeds and speeds for drilling ferrous materials (note: varying conditions can easily require adjustments).

Feed equals .001" per revolution for every 1/16" of drill diameter, plus or minus .001" on the total.

Speed equals 80 surface feet per minute in 100 Brinell hardness material and the speed should be reduced 10 surface feet per minute for each additional 50 points Brinell hardness.

Feed and speed rates should be reduced up to 45-50 % when drilling holes deeper than 4 drill diameters.

Recommended Feeds

RECOMMENDED FEEDS FOR VARIOUS DIAMETER DRILLS	
Diameter of Drill—Inches	Feed Inches per Revolution
Under 1/8	.001 to .003
1/8 to 1/4	.002 to .006
1/4 to 1/2	.004 to .010
1/2 to 1	.007 to .015
1 inch and over	.015 to .025

NOTE: It is best to start with a moderate speed and feed, increasing either one, or both, after observing the action and condition of the drill.

Recommended Speeds

RECOMMENDED SPEEDS FOR STANDARD MATERIALS WITH H.S.S. DRILLS	
Material	Recommended Speed (sfm)
Aluminum and its Alloys	200—300
Brass and Bronze (ordinary)	150—300
Bronze (High Tensile)	70—150
Die Castings (Zinc Base)	300—400
Iron—Cast (soft)	75—125
Cast (medium hard)	50—100
Hard Chilled	10—20
Malleable	80—90
Magnesium and its Alloys	250—400
Monel Metal or High-Nickel Steel	30—50
Plastics or Similar Materials	100—300
Steel—	
Mild .2 carbon to .3 carbon	80—110
Steel .4 carbon to .5 carbon	70—80
Tool 1.2 carbon	50—60
Forgings	40—50
Alloy—300 to 400 Brinell	20—30
High Tensile (Heat Treated)	
35 to 40 Rockwell "C"	30—40
40 to 45 Rockwell "C"	25—35
45 to 50 Rockwell "C"	15—25
50 to 55 Rockwell "C"	7—15
Stainless Steel	
Free Machining Grades	30—80
Work Hardening Grades	15—50
Titanium Alloy Sheet	50—60
Titanium Alloys	
Ti-75A (Commercially Pure)	50—60
RS-120	40—60
Ti-150A	40—50
Ti-140A	30—40
RC-130B	30—40
MST 6A1-4 Va.	20—35
MST 3A1-5 Cr.	10—20

Formulas

- $R.P.M. = (3.8197 / \text{Drill Diameter}) \times S.F.M.$
- $S.F.M. = 0.2618 \times \text{Drill Diameter} \times R.P.M.$
- $I.P.M. = I.P.R. (\text{feed}) \times R.P.M. (\text{speed})$
- $\text{Machine Time (seconds)} = (60 \times \text{Feed minus Stroke}) / I.P.M.$

R.P.M. = Revolutions Per Minute

I.P.R. = Inches Per Revolution

S.F.M. = Surface Feet Per Minute

Feed Stroke = Drill Depth + 1/3

I.P.M. = Inches Per Minute

Car Reamer = 1/2 Speed of Drill

Cutting Speed

DRILL SIZE	CUTTING SPEED — FEET PER MINUTE				
	20	40	60	80	100
	REVOLUTIONS PER MINUTE (000)				
1/64	4.89	9.78	14.78	19.72	24.45
1/16	1.22	2.44	3.70	4.93	6.11
1/8	.61	1.22	1.83	2.44	3.06
3/16	.41	.82	1.23	1.63	2.04
1/4	.30	.61	.92	1.22	1.53
5/16	.24	.49	.74	.98	1.22
3/8	.20	.41	.61	.81	1.02
7/16	.18	.35	.52	.70	.87
1/2	.15	.31	.46	.61	.76
9/16	.14	.27	.41	.54	.68
5/8	.12	.24	.37	.49	.61
11/16	.11	.22	.34	.45	.56
3/4	.10	.20	.31	.41	.51
13/16	.09	.19	.28	.38	.47
7/8	.09	.18	.26	.35	.44
15/16	.08	.16	.25	.33	.41
1	.08	.15	.23	.30	.38

PROBLEM	CAUSE	CORRECTION
BROKEN DRILL	1. Flutes clogged with chips, drill binds in hole (common in deep holes)	—Use drill with wider flutes and/or faster helix angle —Consider polished flutes —Withdraw drill at regular intervals to clear chips —If chips are not broken up, consider heavier feeds—or a chip breaker design
	2. Drill binding due to worn outer corners	—Repoint or replace drill —Check for excessive speed, inadequate or incorrect coolant, excessive run out as drill enters work
	3. Work insecurely held	—Use adequate holding or clamping devices
	4. Excessive feed	—Reduce feed
	5. Improper point	—Check for correct lip clearance —Use proper type of drill and point for the application
	6. Drill is dull	—Replace before dulling occurs. Check feeds, speeds, and No. 5 for premature dulling
BROKEN TANG	1. Shank or socket damaged	—Repair or replace
	2. Drill not properly seated in socket	—Check for positive, secure fit
CHIPS NOT BREAKING UP	1. Insufficient feed	—Increase feed
	2. Improper style of drill and/or point	—Consider use of chip-breaker design drill and/or chip-breaker point grind
DAMAGED POINT	1. Using hard object to tap drill into tool holder	—Use soft lead, brass, plastic, etc. hammer
	2. Dropping, mishandling drill	—Handle with care
OVERSIZE HOLE	1. Drill point off center	—Repoint accurately or replace with properly pointed drill
	2. Machine spindle not rigid or not running true	—Repair if possible; consider use of bushing
	3. Work piece loose and/or vibrating	—Tighten and hold securely
ROUGH HOLE	1. Incorrect point grind and/or dull drill	—Repoint or replace with properly pointed drill
	2. Excessive feed	—Reduce feed
	3. Incorrect or insufficient coolant	—Correct and adjust
POOR TOOL LIFE	1. Coolant not reaching drill point or insufficient or incorrect coolant	—Correct and adjust
	2. Speed too high and/or feed too low	—Review and adjust
	3. Wrong type of point and/or drill for application	—Review requirements and conditions
WEB SPLITS	1. Insufficient lip clearance	—Repoint or replace with properly pointed drill
	2. Point thinned too much	—Repoint or replace with properly pointed drill
	3. Excessive feed	—Reduce feed
CHIPPED LIPS	1. Excessive lip clearance and/or heel relief	—Repoint or replace with properly pointed drill
BROKEN OUTER CORNERS	1. Insufficient or incorrect coolant	—Correct and adjust
	2. Excessive speed	—Reduce speed
	3. Scale, hard spots encountered in material	—No final remedy if this condition is prevalent; lower feeds and speeds may help

Taps & Dies Index

QUICK INDEX - HSS / Hi-Carbon Taps & Dies

HSS Spiral Point Taps

Type 20-AG Fractional / Machine Screw . . .	55
Type 20-AGN Fractional / Machine Screw . . .	55
Type 20 Fractional / Machine Screw	55
Type 21-AG Metric	55
Type 21-AGN Metric - TiN Coated	55
Type 21 Metric	55

HSS Straight Flute Taps

Type 23-AG Taper	58 - 60
Type 23-AGN Taper - TiN Coated	58 - 60
Type 23 Taper	58 - 60
Type 24-AG Plug	58 - 60
Type 24-AGN Plug - TiN Coated	58 - 60
Type 24 Plug	58 - 60
Type 25-AG Bottoming	58 - 60
Type 25-AGN Bottoming - TiN Coated	58 - 60
Type 25 Bottoming	58 - 60
Type 26-AG Sets	61
Type 26-AGN Sets TiN Coated	61
Type 26 Sets	61

HSS Straight Flute -Metric

Type 31-AG Taper	62
Type 31-AGN Taper - TiN Coated	62
Type 31 Taper - Metric	62
Type 32-AG Plug	62
Type 32-AGN Plug - TiN Coated	62
Type 32 Plug - Metric	62
Type 33-AG Bottoming	62
Type 33-AGN Bottoming - TiN Coated	62
Type 33 Bottoming - Metric	62
Type 35-AG Sets	63
Type 35-AGN Sets - TiN Coated	63
Type 35 Sets	63

HSS Straight Flute -Left-Hand Thread

Type 23L-AG Taper	64
Type 24L-AG Plug	64
Type 25L-AG Bottoming	64

HSS Spiral Flute Semi-Bottoming Taps

FRACTIONAL	
Type 36-ACN, 36-UBN, 36 30° Spiral TiCN, TiN	65
Type 37-ACN, 37-UBN, 37 52° Spiral TiCN, TiN	65 - 66

METRIC	
Type 38-ACN, 38-UBN, 38 30° Spiral TiCN, TiN	66
Type 39-ACN, 39-UBN, 39 52° Spiral TiCN, TiN	66

HSS Combination Drill & Tap

Type 40-AG	67
Type 40-QR	67

Drill & Tap Combo

Type 34-AG	67
----------------------	----

HSS Hex Dies

Type 27-AG	68
Type 27-AG Metric	68

NEW Extension Spiral Point Plug Taps

Type 20-EXT	56
-----------------------	----

High Performance Spiral Tap

Type 29-AG	56
Type 29-AGN	56
Type 29-ACN	57
Type 29-ALN	57

M42 Cobalt Taps & TiN Coated

Type 24-RNC	58
Type 24-RNCN Cobalt	58

Taper Pipe Taps

Type 30-AG	63
Type 30-AGN - TiN Coated	63
Type 30-B Black Oxide	63
Type 30 Bright	63

Interrupted Taper Pipe Taps

Type I30-AG Interrupted	63
Type I30-AGN TiN Coated - Interrupted	63
Type I30-B Black Oxide - Interrupted	63
Type I30 Bright - Interrupted	63

HSS Extension Taper Pipe Taps

Type 30-EXT	63
-----------------------	----

HSS Tap & Drill Sets

SF-18TDC Straight Flute	67
SF-18TDF Spiral Flute	67
SP-10TD Straight Point	67
SP-12TD Spiral Point	67
SP-18TD Spiral Point	67
SP-18TDM Spiral Point	67
B-18TD HSS Drill & Tap Set	67

HSS Tap Sets

SP-19T Spiral Point	68
SP-10T Spiral Point	68
SF-10T Straight Flute	68

Drill, Tap & Countersink Set

TDC-12	68
------------------	----

HSS Tap & Die Assortments

Magnum Super Premium	
14pc, 15pc Metric	69
24pc, 25pc Metric	69
40pc	70
58pc	70

Hi-Carbon Steel Taps

Type 720 Plug - Fractional	71
Type 721 Plug - Machine Screw	71
Type 740 Taper - Fractional	71
Type 741 Plug - Machine Screw	71
Type 760 Bottoming - Fractional	72
Type 761 Bottoming - Machine Screw	72
Type 722 3pc. Set - Fractional	72
Type 723 3pc. Set - Machine Screw	72
Type 780 Plug Taps Metric	75

Hi-Carbon Steel Pipe Taps

Type 410 Fractional	75
-------------------------------	----

Hi-Carbon Steel Dies

Type 400 - Round	74
Type 405 - Hex	73
Type 415 - Adjustable	74
Type 790 - Hex Metric	73

Hi-Carbon Tap & Die Sets

Type 724	
14pc, 16pc	76
24pc, 37pc	77
40pc	78

Tap & Reamer Wrenches / Die Stocks

Type 725	79
Type 726	79
Type 727	79
Type 727R Ratcheting T-Handle	79
Type 728	80
Type 728R Round Die Stock NEW	80
Type 729	80
Type 730 Screw Pitch Gauges	80

Technical Reference . . . 81 - 85



HSS SPIRAL POINT PLUG TAPS

Gun Tap - Machine Screw / Fractional & METRIC - Ground Thread - Magnum Super Premium

Types 20-AG Gold Oxide, Type 20-AGN TiN Coated & Type 20 Bright

METRIC Types 21-AG Gold Oxide, Type 21-AGN TiN Coated & Type 21 Bright

- Spiral point taps are designed for machine tapping through holes in a wide variety of materials. The point of the tap continuously ejects the chips ahead of the tap, eliminating chip disposal problems and thread damage.



Type 20-AG

Gold Oxide - low temperature stress relief that enhances lubricity, reduces friction and increases tap toughness.



Type 20-AGN Titanium Nitride

Titanium Nitride - increases wear resistance by producing a higher surface hardness and exceptional lubricity resulting in longer tool life.



Type 20 Bright Finish
Bright Finish

Red Bold = most common used Taps

20-AG Part #	20-AGN Part #	20 Part #	Size	# of Flutes	H Limit	Qty. per/pack
67502	10502	60101	0-80	2	H1	3
60100	10512	67501	0-80	2	H2	3
67512	10522	60111	1-64	2	H1	3
60110	10532	67511	1-64	2	H2	3
67522	10542	67521	1-72	2	H1	3
60120	10552	60121	1-72	2	H2	3
60130	10562	60131	2-56	2	H2	3
60140	10572	60141	2-64	2	H2	3
60150	10582	60151	3-48	2	H2	3
67532	10592	67531	3-56	2	H1	3
60160	10602	60161	3-56	2	H2	3
67542	10612	67541	4-40	2	H1	3
60170	10622	60171	4-40	2	H2	3
67552	10632	67551	4-48	2	H1	3
60180	10642	60181	4-48	2	H2	3
60190	10652	60191	4-36	2	H2	3
67562	10662	67561	5-40	2	H1	3
60200	10672	60201	5-40	2	H2	3
60210	10682	60211	5-44	2	H2	3
67572	10692	67571	6-32	2	H1	3
67582	10702	67581	6-32	2	H2	3
60220	10712	60221	6-32	2	H3	3
60230	10722	60231	6-40	2	H2	3
67592	10732	67591	8-32	2	H1	3
67602	10742	67601	8-32	2	H2	3
60240	10752	60241	8-32	2	H3	3
60250	10762	60251	8-36	2	H2	3
67612	10772	67611	10-24	2	H1	3
67622	10782	67621	10-24	2	H2	3
60260	10792	60261	10-24	2	H3	3
67632	10802	67631	10-32	2	H1	3
67642	10812	67641	10-32	2	H2	3
60270	10822	60271	10-32	2	H3	3
60280	10832	60281	12-24	2	H3	3
60290	10842	60291	12-28	2	H3	3
67652	10852	67651	1/4-20	2	H1	3
67662	10862	67661	1/4-20	2	H2	3
60320	10872	60321	1/4-20	2	H3	3
67672	10882	67671	1/4-20	2	H5	3
67682	10892	67681	1/4-20	3	H3	3
67692	10902	67691	1/4-20	3	H5	3
67702	10912	67701	1/4-28	2	H1	3
67712	10922	67711	1/4-28	2	H2	3
60330	10932	60331	1/4-28	2	H3	3

20-AG Part #	20-AGN Part #	20 Part #	Size	# of Flutes	H Limit	Qty. per/pack
67722	10942	67721	1/4-28	2	H4	3
67732	10952	67731	1/4-28	3	H2	3
67742	10962	67741	1/4-28	3	H4	3
67752	10972	67751	5/16-18	2	H1	3
67762	10982	67761	5/16-18	2	H2	3
60340	10992	60341	5/16-18	2	H3	3
67772	11002	67771	5/16-18	2	H5	3
67782	11012	67781	5/16-18	3	H3	3
67792	11022	67791	5/16-18	3	H5	3
67802	11032	67801	5/16-24	2	H1	3
67812	11042	67811	5/16-24	2	H2	3
60350	11052	60351	5/16-24	2	H3	3
67822	11062	67821	5/16-24	2	H4	3
67832	11072	67831	5/16-24	3	H2	3
67842	11082	67841	5/16-24	3	H4	3
67852	11092	67851	3/8-16	3	H1	3
67862	11102	67861	3/8-16	3	H2	3
60360	11112	60361	3/8-16	3	H3	3
67872	11122	67871	3/8-16	3	H5	3
67882	11132	67881	3/8-24	3	H1	3
67892	11142	67891	3/8-24	3	H2	3
60370	11152	60371	3/8-24	3	H3	3
67902	11162	67901	3/8-24	3	H4	3
67912	11172	67911	7/16-14	3	H2	3
60380	11182	60381	7/16-14	3	H3	3
67922	11192	67921	7/16-14	3	H5	3
60390	11202	60391	7/16-20	3	H3	3
67932	11212	67931	7/16-20	3	H5	3
67942	11222	67941	1/2-13	3	H2	3
60400	11232	60401	1/2-13	3	H3	3
67952	11242	67951	1/2-13	3	H5	3
67962	11252	67961	1/2-20	3	H1	3
67972	11262	67971	1/2-20	3	H2	3
60410	11272	60411	1/2-20	3	H3	3
67982	11282	67981	1/2-20	3	H5	3
67992	-----	60461	9/16-12	3	H3	1
68002	-----	60471	9/16-18	3	H3	1
60420	11292	60421	5/8-11	3	H3	1
68012	11302	67991	5/8-11	3	H5	1
60430	11312	60431	5/8-18	3	H3	1
60440	11322	60441	3/4-10	3	H3	1
68022	11332	68001	3/4-10	3	H5	1
60450	11342	60451	3/4-16	3	H3	1

TYPE 21-AG, TYPE 21-AGN TIN COATED & TYPE 21

METRIC - PLUG

21-AG Part #	21-AGN Part #	21 Part #	Size	# of Flutes	PD Limit	Qty. per/pck
68602	10509	68601	1.6 - 0.35	2	D3	3
68612	10519	68611	1.8 - 0.35	2	D3	3
68622	10529	68621	2.0 - 0.40	2	D3	3
68632	10539	68631	2.20 - 0.45	2	D3	3
60500	10549	68641	2.5 - 0.45	2	D3	3
60510	10559	60102	3.0 - 0.50	2	D3	3
60520	10569	60103	3.5 - 0.60	2	D4	3
60530	10579	60104	4.0 - 0.70	2	D4	3
68642	10589	68651	4.50 - 0.75	2	D4	3
60550	10599	60114	5.0 - 0.80	2	D4	3
60560	10609	60124	6.0 - 1.00	2	D5	3
68652	10619	68661	7.0 - 1.00	2	D5	3

21-AG Part #	21-AGN Part #	21 Part #	Size	# of Flutes	PD Limit	Qty. per/pck
68662	10629	68671	8.0 - 1.00	2	D5	3
60580	10639	60234	8.0 - 1.25	2	D5	3
68672	10649	68681	10.0 - 1.25	3	D5	3
60600	10659	60152	10.0 - 1.50	3	D6	3
68682	10669	68691	12.0 - 1.25	3	D5	3
60620	10679	60162	12.0 - 1.75	3	D6	3
68692	10689	68701	14.0 - 1.50	3	D6	1
60630	10699	60164	14.0 - 2.00	3	D7	1
68702	10709	68711	16.0 - 1.50	3	D6	1
60640	10719	60173	16.0 - 2.00	3	D7	1
60650	10729	60174	18.0 - 2.50	3	D7	1
68712	10739	68721	20.0 - 2.50	3	D7	1

Taps & Dies



SPIRAL POINT PLUG TAPS - EXTENSION SMALL SHANK

Type 20-EXT

- 6-inch spiral point plug extension tap used to thread deep and hard to reach holes.
- Square shank compatible with tap wrenches and tap holders.
- High Speed Steel.



TYPE 20-EXT

Part #	Size	# of Flutes	H Limits	Qty. per /pack	Part #	Size	# of Flutes	H Limits	Qty. per /pack	Part #	Size	# of Flutes	H Limits	Qty. per /pack
66642	6-32	2	H3	1	66742	5/16-18	3	H3	1	66802	1/2-13	3	H3	1
66662	8-32	2	H3	1	66752	5/16-24	2	H3	1	66812	1/2-20	3	H3	1
66682	10-24	2	H3	1	66762	3/8-16	2	H3	1	66822	5/8-11	3	H3	1
66692	10-32	2	H3	1	66772	3/8-24	3	H3	1	66832	5/8-18	3	H3	1
66722	1/4-20	2	H3	1	66782	7/16-14	3	H3	1	66842	3/4-10	3	H3	1
66732	1/4-28	2	H3	1	66792	7/16-20	3	H3	1	66852	3/4-16	3	H3	1

HIGH PERFORMANCE REDUCED NECK - SPIRAL POINT TAPS

Machine Screw / Fractional & METRIC - Magnum Super Premium

Type 29-AG - Gold Oxide

Type 29-AGN - Titanium Nitride

- Special tool geometry creates less torque, better removal of chips and runs cooler.
- Designed for difficult materials including: **stainless steel, alloy steels and high carbon steel.**



Type 29-AG Gold Oxide

Gold Oxide - low temperature stress relief that enhances lubricity, reduces friction and increases tap toughness.



Type 29-AGN Titanium Nitride

Titanium Nitride - increases wear resistance by producing a higher surface hardness and exceptional lubricity resulting in longer tool life.

GOLD OXIDE

TYPE 29-AG

Part #	Size	# of Flutes	H Limits	Qty. per /pack	Part #	Size	# of Flutes	H Limits	Qty. per /pack	Part #	Size	# of Flutes	H Limits	Qty. per /pack
44264	2-56	2	H2	3	44360	10-32A	3	H3	3	20100	7/16-14	3	H3	3
44284	3-48	2	H2	3	44374	12-24	2	H3	3	20110	7/16-20	3	H3	3
44300	4-40	2	H2	3	44370	12-24A	3	H3	3	20120	1/2-13	3	H3	3
44294	4-48	2	H2	3	44384	12-28	2	H3	3	20130	1/2-20	3	H3	3
44304	5-40	2	H2	3	44380	12-28A	3	H3	3	20163	9/16-12	3	H3	1
44309	5-44	2	H2	3	20013	1/4-20	2	H3	3	20173	9/16-18	3	H3	1
44310	6-32	3	H3	3	20010	1/4-20A	3	H3	3	20183	5/8-11	3	H3	1
44320	6-40	3	H2	3	20023	1/4-28	2	H3	3	20193	5/8-18	3	H3	1
44334	8-32	2	H3	3	20020	1/4-28A	3	H2	3	20203	3/4-10	3	H3	1
44330	8-32A	3	H3	3	20033	5/16-18	2	H3	3	20213	3/4-16	3	H3	1
44344	8-36	2	H2	3	20030	5/16-18A	3	H3	3	20223	7/8-9	3	H3	1
44340	8-36A	3	H2	3	20043	5/16-24	2	H3	3	20233	7/8-14	3	H3	1
44354	10-24	2	H3	3	20040	5/16-24A	3	H2	3	20243	1-8	3	H3	1
44350	10-24A	3	H3	3	20050	3/8-16	3	H3	3	20253	1-14	3	H3	1
44364	10-32	2	H3	3	20060	3/8-24	3	H3	3					

METRIC

Part #	Size	# of Flutes	PD Limits	Qty. per /pack
24494	3-.50	2	D3	3
24514	4-.70	3	D4	3
24534	5-.80	3	D4	3
24544	6-1.00	3	D5	3
24574	8-1.25	3	D5	3
24594	10-1.50	3	D6	3
24614	12-1.75	3	D6	3
24634	14-2.00	3	D7	1
24654	16-2.00	3	D7	1

TITANIUM NITRIDE

TYPE 29-AGN

Part #	Size	# of Flutes	H Limits	Qty. per /pack	Part #	Size	# of Flutes	H Limits	Qty. per /pack	Part #	Size	# of Flutes	H Limits	Qty. per /pack
09501	2-56	2	H2	3	09691	12-28A	3	H3	3	09881	3/4-10	3	H3	1
09511	3-48	2	H2	3	09701	1/4-20	2	H3	3	09891	3/4-16	3	H3	1
09521	4-40	2	H2	3	09711	1/4-20A	3	H3	3	09901	7/8-9	3	H3	1
09531	4-48	2	H2	3	09721	1/4-28	2	H3	3	09911	7/8-14	3	H3	1
09541	5-40	2	H2	3	09731	1/4-28A	3	H2	3	09921	1-8	3	H3	1
09551	5-44	2	H2	3	09741	5/16-18	2	H3	3	09931	1-14	3	H3	1
09561	6-32	3	H3	3	09751	5/16-18A	3	H3	3					
09571	6-40	3	H2	3	09761	5/16-24	2	H3	3					
09581	8-32	2	H3	3	09771	5/16-24A	3	H2	3					
09591	8-32A	3	H3	3	09781	3/8-16	3	H3	3					
09601	8-36	2	H2	3	09791	3/8-24	3	H3	3					
09611	8-36A	3	H2	3	09801	7/16-14	3	H3	3					
09621	10-24	2	H3	3	09811	7/16-20	3	H3	3					
09631	10-24A	3	H3	3	09821	1/2-13	3	H3	3					
09641	10-32	2	H3	3	09831	1/2-20	3	H3	3					
09651	10-32A	3	H3	3	09841	9/16-12	3	H3	1					
09661	12-24	2	H3	3	09851	9/16-18	3	H3	1					
09671	12-24A	3	H3	3	09861	5/8-11	3	H3	1					
09681	12-28	2	H3	3	09871	5/8-18	3	H3	1					

METRIC

Part #	Size	# of Flutes	PD Limits	Qty. per /pack
09941	3-.50	2	D3	3
09951	4-.70	3	D4	3
09961	5-.80	3	D4	3
09971	6-1.00	3	D5	3
09981	8-1.25	3	D5	3
09991	10-1.50	3	D6	3
10001	12-1.75	3	D6	3
10011	14-2.00	3	D7	1
10021	16-2.00	3	D7	1

HIGH PERFORMANCE REDUCED NECK - SPIRAL POINT TAPS

Machine Screw / Fractional & **METRIC** - Magnum Super Premium

Type 29-ACN - Titanium Carbon Nitride

Type 29-ALN - Titanium Aluminum Nitride

- **Titanium Carbon Nitride** - TiCN coating that is harder than TiN coating resulting in longer tool life and enhanced performance.
- Designed for use in multiple applications.

Titanium Aluminum Nitride - TiAlN coating provides extreme toughness, recommended for high temperature operations and difficult to machine materials.

- Designed for hardened steels and cast iron up to 45 Rockwell C.



TiCN Coating

Titanium Carbon Nitride (TiCN) Hi productivity when threading stainless steel, nickel and aluminum for use in multiple applications



TiAlN Coating

Titanium Aluminum Nitride (TiAlN) ideal for threading hard materials designed for hardened steels and cast iron up to 45 Rockwell C.

TITANIUM CARBON NITRIDE

TYPE 29-ACN

Part #	Size	# of Flutes	H Limits	Qty. per /pack
31001	2-56	2	H2	3
31011	3-48	2	H2	3
31021	4-40	2	H2	3
31031	4-48	2	H2	3
31041	5-40	2	H2	3
31051	5-44	2	H2	3
31061	6-32	3	H3	3
31071	6-40	3	H2	3
31081	8-32	2	H3	3
31091	8-32A	3	H3	3
31101	8-36	2	H2	3
31111	8-36A	3	H2	3
31121	10-24	2	H3	3
31131	10-24A	3	H3	3
31141	10-32	2	H3	3
31151	10-32A	3	H3	3
31161	12-24	2	H3	3
31171	12-24A	3	H3	3
31181	12-28	2	H3	3

Part #	Size	# of Flutes	H Limits	Qty. per /pack
31191	12-28A	3	H3	3
31201	1/4-20	2	H3	3
31211	1/4-20A	3	H3	3
31221	1/4-28	2	H3	3
31231	1/4-28A	3	H2	3
31241	5/16-18	2	H3	3
31251	5/16-18A	3	H3	3
31261	5/16-24	2	H3	3
31271	5/16-24A	3	H2	3
31281	3/8-16	3	H3	3
31291	3/8-24	3	H3	3
31301	7/16-14	3	H3	3
31311	7/16-20	3	H3	3
31321	1/2-13	3	H3	3
31331	1/2-20	3	H3	3
31341	9/16-12	3	H3	1
31351	9/16-18	3	H3	1
31361	5/8-11	3	H3	1

Part #	Size	# of Flutes	H Limits	Qty. per /pack
31371	5/8-18	3	H3	1
31381	3/4-10	3	H3	1
31391	3/4-16	3	H3	1
31401	7/8-9	3	H3	1
31411	7/8-14	3	H3	1
31421	1-8	3	H3	1
31431	1-14	3	H3	1

METRIC

Part#	Size	# of Flutes	PD Limits	Qty. per /pack
31441	3-.50	2	D3	3
31451	4-.70	3	D4	3
31461	5-.80	3	D4	3
31471	6-1.00	3	D5	3
31481	8-1.25	3	D5	3
31491	10-1.50	3	D6	3
31501	12-1.75	3	D6	3
31511	14-2.00	3	D7	1
31521	16-2.00	3	D7	1

TITANIUM ALUMINUM NITRIDE

TYPE 29-ALN

Part #	Size	# of Flutes	H Limits	Qty. per /pack
56301	2-56	2	H2	3
56311	3-48	2	H2	3
56321	4-40	2	H2	3
56331	4-48	2	H2	3
56341	5-40	2	H2	3
56351	5-44	2	H2	3
56361	6-32	3	H3	3
56371	6-40	3	H2	3
56381	8-32	2	H3	3
56391	8-32A	3	H3	3
56401	8-36	2	H2	3
56411	8-36A	3	H2	3
56421	10-24	2	H3	3
56431	10-24A	3	H3	3
56441	10-32	2	H3	3
56451	10-32A	3	H3	3
56461	12-24	2	H3	3
56471	12-24A	3	H3	3

Part #	Size	# of Flutes	H Limits	Qty. per /pack
56481	12-28	2	H3	3
56491	12-28A	3	H3	3
56501	1/4-20	2	H3	3
56511	1/4-20A	3	H3	3
56521	1/4-28	2	H3	3
56531	1/4-28A	3	H2	3
56541	5/16-18	2	H3	3
56551	5/16-18A	3	H3	3
56561	5/16-24	2	H3	3
56571	5/16-24A	3	H2	3
56581	3/8-16	3	H3	3
56591	3/8-24	3	H3	3
56601	7/16-14	3	H3	3
56611	7/16-20	3	H3	3
56621	1/2-13	3	H3	3
56631	1/2-20	3	H3	3
56641	9/16-12	3	H3	1
56651	9/16-18	3	H3	1
56661	5/8-11	3	H3	1

Part #	Size	# of Flutes	H Limits	Qty. per /pack
56671	5/8-18	3	H3	1
56681	3/4-10	3	H3	1
56691	3/4-16	3	H3	1
56701	7/8-9	3	H3	1
56711	7/8-14	3	H3	1
56721	1-8	3	H3	1
56731	1-14	3	H3	1

METRIC

Part#	Size	# of Flutes	PD Limits	Qty. per /pack
56741	3-.50	2	D3	3
56751	4-.70	3	D4	3
56761	5-.80	3	D4	3
56771	6-1.00	3	D5	3
56781	8-1.25	3	D5	3
56791	10-1.50	3	D6	3
56801	12-1.75	3	D6	3
56811	14-2.00	3	D7	1
56821	16-2.00	3	D7	1

Taps & Dies

M42 COBALT TAPS & TITANIUM NITRIDE

Type 24- RNC Bright Finish Type 24-RNCN Titanium Nitride Fractional - Taps for Hardened Steel and Iron

- M-42 plug taps for tapping through holes in mold steel and hardened steel with Rockwell C hardness between C30 – C45.
- Titanium coated M-42 plug taps last twice as long as uncoated taps, titanium coatings lubricity produces smooth threads. **For use in** cast iron, brass, bronze, armor plate with a Rockwell C hardness between C30 – C45 and hard plastics.



Bright Part #	Titanium Nitride Part #	Bright Part #	Thread Size	Thread Length	Overall Length	Shank Diameter	Drill Bit Size	# of Flutes	Pitch Limit Dia.	Qty Per Pack
10032	13782		2-56	7/16"	1-13/16"	0.1405	#51	2	H2	3
10052	13802		4-40	5/16"	1-7/8"	0.1405	#43	3	H2	3
10072	13822		5-40	5/16"	1-15/16"	0.1405	#38	3	H2	3
10092	13842		6-32	3/8"	2"	0.1405	#36	3	H3	3
10112	13862		8-32	3/8"	2-1/8"	0.1675	#29	3	H3	3
10132	13882		10-24	1/2"	2-3/8"	0.1935	#25	3	H3	3
10142	13892		10-32	1/2"	2-3/8"	0.1935	#21	3	H3	3
10152	13902		12-24	1/2"	2-1/2"	0.2195	#16	2	H3	3
10172	13922		1/4-20	5/8"	2-1/2"	0.2545	#7	3	H3	3
10182	13932		1/4-28	5/8"	2-1/2"	0.2545	#3	3	H3	3
10192	13942		5/16-18	11/16"	2-23/32"	0.3175	F	4	H3	3
10202	13952		5/16-24	11/16"	2-23/32"	0.3175	I	4	H3	3
10212	13962		3/8-16	3/4"	2-15/16"	0.3805	5/16"	4	H3	3
10222	13972		3/8-24	3/4"	2-15/16"	0.3805	Q	4	H3	3
10232	13982		7/16-14	7/8"	3-5/32"	0.3225	U	4	H3	3
10242	13992		7/16-20	7/8"	3-5/32"	0.3225	25/64"	4	H3	3
10272	14002		1/2-13	15/16"	3-3/8"	0.3665	27/64"	4	H3	3
10282	14012		1/2-20	15/16"	3-3/8"	0.3665	29/64"	4	H3	3
10292	14042		5/8-11	1-3/32"	3-13/16"	0.4795	17/32"	4	H3	1
10302	14052		5/8-18	1-3/32"	3-13/16"	0.4795	37/64"	4	H3	1
10312	14062		3/4-10	1-7/32"	4-1/4"	0.5895	21/32"	4	H3	1
10322	14072		3/4-16	1-7/32"	4-1/4"	0.5895	11/16"	4	H3	1
10352	14102		1"-8	2-1/2"	5-1/8"	0.7995	7/8"	3	H4	1

HSS STRAIGHT FLUTE HAND TAPS

Machine Screw / Fractional - Ground Thread Types 23-AG, Type 24-AG & Type 25-AG Gold Oxide

Types 23-AGN, Type 24-AGN & Type 25-AGN Titanium Nitride Types 23, Type 24 & Type 25 Bright Finish

- The most common style of tap
- Can be used by hand or for tapping under power
- Versatile taps for use in general machine tapping or CNC tapping applications
- Use for through hole or blind hole tapping.



Type 23-AG - Taper

Gold Oxide - low temperature stress relief that enhances lubricity, reduces friction and increases tap toughness.



Type 24-AGN - Plug

Titanium Nitride - increases wear resistance by producing a higher surface hardness and exceptional lubricity resulting in longer tool life.



Type 25 - Bottoming
Bright Finish

Red Bold = most common used Taps

23-AG Taper Part#	24-AG Plug Part #	25-AG Bottoming Part #	23-AGN Taper Part #	24-AGN Plug Part #	25-AGN Bottoming Part #	23 Taper Part #	24 Plug Part #	25 Bottoming Part #	Size	# of Flutes	H Limit	QTY per/pack
72701	72702	72703	45981	45982	45983	71661	71662	71663	0-80	2	H1	3
72711	72712	72713	45991	45992	45993	71671	71672	71673	0-80	2	H2	3
72721	72722	72723	44101	44102	44103	71681	71682	71683	1-64	2	H1	3
72731	72732	72733	44111	44112	44113	71691	71692	71693	1-64	2	H2	3
72741	72742	72743	44121	44122	44123	71701	71702	71703	1-72	2	H1	3
72751	72752	72753	44131	44132	44133	71711	71712	71713	1-72	2	H2	3
72761	72762	72763	44141	44142	44143	71721	71722	71723	2-56	2	H1	3
60660	60661	60662	46001	46002	46003	71231	71232	71233	2-56	2	H2	3
72771	72772	72773	44151	44152	44153	71731	71732	71733	2-64	2	H2	3
72781	72782	72783	44161	44162	44163	71741	71742	71743	3-48	3	H1	3
60680	60681	60682	46011	46012	46013	71251	71252	71253	3-48	3	H2	3
60710	60711	60712	45931	45932	45933	71751	71752	71753	3-56	3	H2	3
60700	60701	60702	46021	46022	46023	61001	61002	61003	4-40	3	H2	3
60720	60721	60722	45951	45952	45953	61011	61012	61013	4-48	3	H2	3
72791	72792	72793	44191	44192	44193	71761	71762	71763	5-40	3	H1	3
60730	60731	60732	46031	46032	46033	61021	61022	61023	5-40	3	H2	3
60740	60741	60742	45971	45972	45973	61031	61032	61033	5-44	3	H2	3
72801	72802	72803	44211	44212	44213	71771	71772	71773	6-32	3	H1	3
72811	72812	72813	44221	44222	44223	71781	71782	71783	6-32	3	H2	3
60750	60751	60752	46041	46042	46043	61041	61042	61043	6-32	3	H3	3
72821	72822	72823	44231	44232	44233	71791	71792	71793	6-40	3	H1	3
60760	60761	60762	46051	46052	46053	61051	61052	61053	6-40	3	H2	3
72831	72832	72833	44241	44242	44243	71801	71802	71803	8-32	4	H1	3
72841	72842	72843	44251	44252	44253	71811	71812	71813	8-32	4	H2	3
60770	60771	60772	46061	46062	46063	61061	61062	61063	8-32	4	H3	3
60780	60781	60782	46071	46072	46073	61071	61072	61073	8-36	4	H2	3
72851	72852	72853	44261	44262	44263	71821	71822	71823	10-24	4	H1	3

HSS STRAIGHT FLUTE HAND TAPS

Machine Screw / Fractional - Ground Thread - Magnum Super Premium

Types 23-AG, Type 24-AG & Type 25-AG **Gold Oxide**

Types 23-AGN, Type 24-AGN & Type 25-AGN **Titanium Nitride**

Types 23, Type 24 & Type 25 **Bright Finish**

- The most common style of tap
- Can be used by hand or for tapping under power
- Versatile taps for use in general machine tapping or CNC tapping applications
- Use for through hole or blind hole tapping



Type 23-AG - Taper

Gold Oxide - low temperature stress relief that enhances lubricity, reduces friction and increases tap toughness.



Type 24-AGN - Plug

Titanium Nitride - increases wear resistance by producing a higher surface hardness and exceptional lubricity resulting in longer tool life.



Type 25 - Bottoming
Bright Finish

Red Bold = most common used Taps

23-AG Taper Part#	24-AG Plug Part #	25-AG Bottoming Part #	23-AGN Taper Part #	24-AGN Plug Part #	25-AGN Bottoming Part #	23 Taper Part #	24 Plug Part #	25 Bottoming Part #	Size	# of Flutes	H Limit	QTY per/pack
72861	72862	72863	44271	44272	44273	71831	71832	71833	10-24	4	H2	3
60790	60791	60792	46081	46082	46083	61081	61082	61083	10-24	4	H3	3
72871	72872	72873	44281	44282	44283	71841	71842	71843	10-32	4	H1	3
72881	72882	72883	44291	44292	44293	71851	71852	71853	10-32	4	H2	3
60800	60801	60802	46091	46092	46093	61091	61092	61093	10-32	4	H3	3
60810	60811	60812	46101	46102	46103	61101	61102	61103	12-24	4	H3	3
60820	60821	60822	46111	46112	46113	61111	61112	61113	12-28	4	H3	3
72891	72892	72893	44301	44302	44303	71861	71862	71863	1/4-20	4	H1	3
72901	72902	72903	44311	44312	44313	71871	71872	71873	1/4-20	4	H2	3
60830	60831	60832	46121	46122	46123	61121	61122	61123	1/4-20	4	H3	3
72911	72912	72913	44321	44322	44323	71881	71882	71883	1/4-20	4	H5	3
72921	72922	72923	44331	44332	44333	71891	71892	71893	1/4-28	4	H1	3
72931	72932	72933	44341	44342	44343	71901	71902	71903	1/4-28	4	H2	3
60840	60841	60842	46131	46132	46133	61131	61132	61133	1/4-28	4	H3	3
72941	72942	72943	44351	44352	44353	71911	71912	71913	1/4-28	4	H4	3
72951	72952	72953	44361	44362	44363	71921	71922	71923	5/16-18	4	H2	3
60850	60851	60852	46141	46142	46143	61141	61142	61143	5/16-18	4	H3	3
72961	72962	72963	44371	44372	44373	71931	71932	71933	5/16-18	4	H5	3
72971	72972	72973	44381	44382	44383	71941	71942	71943	5/16-24	4	H2	3
60860	60861	60862	46151	46152	46153	61151	61152	61153	5/16-24	4	H3	3
72981	72982	72983	44391	44392	44393	71951	71952	71953	5/16-24	4	H4	3
72991	72992	72993	44401	44402	44403	71961	71962	71963	3/8-16	4	H1	3
73001	73002	73003	44411	44412	44413	71971	71972	71973	3/8-16	4	H2	3
60870	60871	60872	46161	46162	46163	61161	61162	61163	3/8-16	4	H3	3
73011	73012	73013	44421	44422	44423	71981	71982	71983	3/8-16	4	H5	3
73021	73022	73023	44431	44432	44433	71991	71992	71993	3/8-24	4	H1	3
73031	73032	73033	44441	44442	44443	72001	72002	72003	3/8-24	4	H2	3
60880	60881	60882	46171	46172	46173	61171	61172	61173	3/8-24	4	H3	3
73041	73042	73043	44451	44452	44453	72011	72012	72013	3/8-24	4	H4	3
60890	60891	60892	46181	46182	46183	61181	61182	61183	7/16-14	4	H3	3
73051	73052	73053	44461	44462	44463	72021	72022	72023	7/16-14	4	H5	3
60900	60901	60902	46191	46192	46193	61191	61192	61193	7/16-20	4	H3	3
73061	73062	73063	44471	44472	44473	72031	72032	72033	7/16-20	4	H5	3
73071	73072	73073	44481	44482	44483	72041	72042	72043	1/2-13	4	H1	3
60910	60911	60912	46201	46202	46203	61201	61202	61203	1/2-13	4	H3	3
73081	73082	73083	44491	44492	44493	72051	72052	72053	1/2-13	4	H5	3
73091	73092	73093	44501	44502	44503	72061	72062	72063	1/2-20	4	H1	3
60920	60921	60922	46211	46212	46213	61211	61212	61213	1/2-20	4	H3	3
73101	73102	73103	44511	44512	44513	72071	72072	72073	1/2-20	4	H5	3
60950	60951	60952	46221	46222	46223	55011	55012	55013	9/16-12	4	H3	1

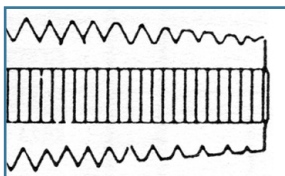

TAPER
Type 23-AG, 23-AGN, 23
Type 31-AG, 31-AGN, 31
Eight to ten threads chamfered for
easy thread starting in tough materials.

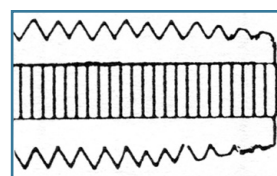

PLUG
Type 24-AG, 24-AGN, 24
Type 32-AG, 32-AGN, 32
Three to five threads
chamfered. For general use when tapping into
the bottom of the hole is not critical. (This is the
most widely used style.)

Taps & Dies

HSS STRAIGHT FLUTE HAND TAPS

Machine Screw / Fractional - Ground Thread - Magnum Super Premium

Types 23-AG, Type 24-AG & Type 25-AG - Gold Oxide

Types 23-AGN, Type 24-AGN & Type 25-AGN - Titanium Nitride

Types 23, Type 24 & Type 25 - Bright Finish

- The most common style of tap
- Can be used by hand or for tapping under power
- Versatile taps for use in general machine tapping or CNC tapping applications
- Use for through hole or blind hole tapping



Type 23-AG - Taper

Gold Oxide - low temperature stress relief that enhances lubricity, reduces friction and increases tap toughness.



Type 24-AGN - Plug

Titanium Nitride- increases wear resistance by producing a higher surface hardness and exceptional lubricity resulting in longer tool life.



Type 25 - Bottoming
Bright Finish

Red Bold = most common used Taps

23-AG Taper Part#	24-AG Plug Part #	25-AG Bottoming Part #	23-AGN Taper Part #	24-AGN Plug Part #	25-AGN Bottoming Part #	23 Taper Part #	24 Plug Part #	25 Bottoming Part #	Size	# of Flutes	H Limit	QTY per/pack
73111	73112	73113	44521	44522	44523	72081	72082	72083	9/16-12	4	H5	1
73121	73122	73123	44531	44532	44533	72091	72092	72093	9/16-18	4	H2	1
60960	60961	60962	46231	46232	46233	55021	55022	55023	9/16-18	4	H3	1
73131	73132	73133	44541	44542	44543	72101	72102	72103	9/16-18	4	H5	1
73141	73142	73143	44551	44552	44553	72111	72112	72113	5/8-11	4	H2	1
60970	60971	60972	46241	46242	46243	55031	55032	55033	5/8-11	4	H3	1
73151	73152	73153	44561	44562	44563	72121	72122	72123	5/8-11	4	H5	1
73161	73162	73163	44571	44572	44573	72131	72132	72133	5/8-18	4	H2	1
60980	60981	60982	46251	46252	46253	55041	55042	55043	5/8-18	4	H3	1
73171	73172	73173	44581	44582	44583	72141	72142	72143	5/8-18	4	H5	1
73181	73182	73183	44591	44592	44593	72151	72152	72153	11/16-11	4	H3	1
73191	73192	73193	44601	44602	44603	72161	72162	72163	11/16-16	4	H3	1
60990	60991	60992	46261	46262	46263	55051	55052	55053	3/4-10	4	H3	1
73201	73202	73203	44611	44612	44613	72171	72172	72173	3/4-10	4	H5	1
73211	73212	73213	44621	44622	44623	72181	72182	72183	3/4-16	4	H1	1
73221	73222	73223	44631	44632	44633	72191	72192	72193	3/4-16	4	H2	1
61400	61401	61402	46271	46272	46273	55061	55062	55063	3/4-16	4	H3	1
73231	73232	73233	44641	44642	44643	72201	72202	72203	3/4-16	4	H5	1
61410	61411	61412	46281	46282	46283	55071	55072	55073	7/8-9	4	H4	1
73241	73242	73243	44651	44652	44653	72211	72212	72213	7/8-9	4	H6	1
73251	73252	73253	44661	44662	44663	72221	72222	72223	7/8-14	4	H2	1
61420	61421	61422	46291	46292	46293	55081	55082	55083	7/8-14	4	H4	1
73261	73262	73263	44671	44672	44673	72231	72232	72233	7/8-14	4	H6	1
61430	61431	61432	46301	46302	46303	55091	55092	55093	1"-8	4	H4	1
73271	73272	73273	44681	44682	44683	72241	72242	72243	1"-8	4	H6	1
61440	61441	61442	46311	46312	46313	55101	55102	55103	1"-12	4	H4	1
27570	27571	27572	46321	46322	46323	55111	55112	55113	1"-14	4	H4	1
61450	61451	61452	46331	46332	46333	55121	55122	55123	1" 1/8-7	4	H4	1
61460	61461	61462	46341	46342	46343	55131	55132	55133	1" 1/8-12	4	H4	1
61470	61471	61472	46351	46352	46353	55141	55142	55143	1" 1/4-7	4	H4	1
61480	61481	61482	46361	46362	46363	55151	55152	55153	1" 1/4-12	6	H4	1
61490	61491	61492	46371	46372	46373	55161	55162	55163	1" 3/8-6	4	H4	1
61500	61501	61502	46381	46382	46383	55171	55172	55173	1" 3/8-12	6	H4	1
61510	61511	61512	46391	46392	46393	55181	55182	55183	1" 1/2-6	4	H4	1
61520	61521	61522	46401	46402	46403	55191	55192	55193	1" 1/2-12	6	H4	1

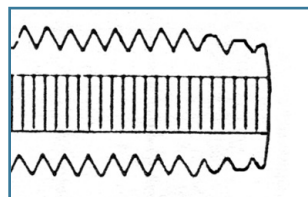

BOTTOMING

Type 25-AG, 25-AGN, 25
Type 33-AG, 33-AGN, 33

One to Two threads chamfered. To use after threads have been started for tapping to the bottom of a hole.

STRAIGHT FLUTES HAND TAPS SETS

Straight Flute Hand Taps Machine Screw / Fractional - Taper, Plug, Bottoming Ground Thread - High Speed Steel

- Includes one each Taper, Plug and Bottoming
 - The most common style of tap
 - Can be used by hand or for tapping under power
- Versatile taps for use in general machine tapping or CNC tapping applications
 - Use for through hole or blind hole tapping



Type 26-AG - Gold Oxide

Gold Oxide - low temperature stress relief that enhances lubricity, reduces friction and increases tap toughness.

Type 26-AGN - Titanium Nitride

TiN coating increases wear resistance by producing a higher surface hardness and exceptional lubricity resulting in longer tool life.

Type 26 - Bright Finish

26-AG Gold Oxide Part #	26-AGN Titanium Nitride Part #	Type 26 Bright Part #	Size	# of Flutes	H Limit	Qty. per/pack each
60663	46004	71724	2-56	3	H2	1
60683	46014	71744	3-48	3	H2	1
60703	46024	61004	4-40	3	H2	1
60723	45954	61014	4-48	3	H2	1
60733	46034	61024	5-40	3	H2	1
60743	45974	61034	5-44	3	H2	1
60753	46044	61044	6-32	3	H3	1
60763	46054	61054	6-40	3	H2	1
60773	46064	61064	8-32	4	H3	1
60783	46074	61074	8-36	4	H2	1
60793	46084	61084	10-24	4	H3	1
60803	46094	61094	10-32	4	H3	1
60813	46104	61104	12-24	4	H3	1
60823	46114	61114	12-28	4	H3	1
60833	46124	61124	1/4-20	4	H3	1
60843	46134	61134	1/4-28	4	H3	1
60853	46144	61144	5/16-18	4	H3	1
60863	46154	61154	5/16-24	4	H3	1
60873	46164	61164	3/8-16	4	H3	1
60883	46174	61174	3/8-24	4	H3	1
60893	46184	61184	7/16-14	4	H3	1
60903	46194	61194	7/16-20	4	H3	1
60913	46204	61204	1/2-13	4	H3	1
60923	46214	61214	1/2-20	4	H3	1
60953	46224	55014	9/16-12	4	H3	1
60963	46234	55024	9/16-18	4	H3	1
60973	46244	55034	5/8-11	4	H3	1
60983	46254	55044	5/8-18	4	H3	1
60993	46264	55054	3/4-10	4	H3	1
61403	46274	55064	3/4-16	4	H3	1
61413	46284	55074	7/8-9	4	H4	1
61423	46294	55084	7/8-14	4	H4	1
61433	46304	55094	1"-8	4	H4	1
61443	46314	55104	1"-12	4	H4	1
27573	46324	55114	1"-14	4	H4	1
61453	46334	55124	1 1/8-7	4	H4	1
61463	46344	55134	1 1/8-12	4	H4	1
61473	46354	55144	1 1/4-7	4	H4	1
61483	46364	55154	1 1/4-12	6	H4	1
61493	46374	55164	1 3/8-6	4	H4	1
61503	46384	55174	1 3/8-12	6	H4	1
61513	46394	55184	1 1/2-6	4	H4	1
61523	46404	55194	1 1/2-12	6	H4	1

HSS Taps

METRIC - STRAIGHT FLUTE HAND TAPS

Straight Flute Hand Taps - Gold Oxide Ground Thread - High Speed Steel

Type 31-AG, 31-AGN, 31-Taper, Type 32-AG, 32-AGN, 32-Plug Type 33-AG, 33-AGN, 33-Bottoming

- The most common style of tap
- Can be used by hand or for tapping under power
- Versatile taps for use in general machine tapping or CNC tapping applications
- Use for through hole or blind hole tapping



Type 31-AG - Taper

Gold Oxide - low temperature stress relief that enhances lubricity, reduces friction and increases tap toughness.



Type 32-AGN - Plug

Titanium Nitride - increases wear resistance by producing a higher surface hardness and exceptional lubricity resulting in longer tool life..



Type 33 - Bottoming

Bright Finish

METRIC

HSS Taps - Metric Straight Flute Hand & TIN Coated Taps

31-AG Taper Part #	32-AG Plug Part #	33-AG Bottoming Part #	31-AGN Taper Part #	32-AGN Plug Part #	33-AGN Bottoming Part #	31 Taper Part #	32 Plug Part #	33 Bottoming Part #	Size	# of Flutes	PD Limit	QTY. per/pack
60329	61569	61561	37661	37662	37663	54691	54692	54693	1.6-0.35	2	D3	3
60339	61579	61571	37691	37692	37693	54701	54702	54703	1.8-0.35	2	D3	3
60349	61589	61581	37711	37712	37713	54711	54712	54713	2.0-0.40	2	D3	3
60359	61599	61591	37701	37702	37703	54721	54722	54723	2.2-0.45	2	D3	3
60379	61629	61681	37731	37732	37733	54731	54732	54733	2.5-0.45	2	D3	3
60389	61631	61682	37741	37742	37743	54741	54742	54743	3.0-0.50	3	D3	3
60519	61632	61683	37751	37752	37753	54751	54752	54753	3.5-0.60	3	D4	3
60529	61633	61684	37761	37762	37763	54761	54762	54763	4.0-0.70	4	D4	3
60369	61634	61689	37771	37772	37773	54771	54772	54773	4.5-0.75	4	D4	3
60539	61639	61691	37781	37782	37783	54781	54782	54783	5.0-0.80	4	D4	3
60549	61641	61692	37791	37792	37793	54791	54792	54793	6.0-1.00	4	D5	3
60559	61642	61693	37801	37802	37803	54801	54802	54803	7.0-1.00	4	D5	3
60569	61643	61694	37811	37812	37813	54811	54812	54813	8.0-1.00	4	D5	3
60579	61644	61699	37821	37822	37823	54821	54822	54823	8.0-1.25	4	D5	3
60589	61649	61701	37831	37832	37833	54831	54832	54833	10.0-1.25	4	D5	3
60611	61651	61702	37841	37842	37843	54841	54842	54843	10.0-1.50	4	D6	3
61601	61652	61703	37851	37852	37853	54851	54852	54853	12.0-1.25	4	D5	3
61901	61911	61921	38451	38452	38453	55201	55202	55203	12.0-1.50	4	D6	3
61602	61653	61704	37861	37862	37863	54861	54862	54863	12.0-1.75	4	D6	3
61603	61654	61709	37871	37872	37873	54871	54872	54873	14.0-1.50	4	D6	1
61604	61659	61711	37881	37882	37883	54881	54882	54883	14.0-2.00	4	D7	1
61609	61661	61712	37891	37892	37893	54891	54892	54893	16.0-1.50	4	D6	1
61611	61662	61713	37901	37902	37903	54901	54902	54903	16.0-2.00	4	D7	1
61281	61282	61283	38491	38492	38493	54911	54912	54913	18.0-1.50	4	D6	1
61612	61663	61714	37911	37912	37913	54921	54922	54923	18.0-2.50	4	D7	1
66361	66362	66363	38501	38502	38503	55251	55252	55253	20.0-1.50	4	D6	1
61613	61664	61719	37921	37922	37923	54931	54932	54933	20.0-2.50	4	D7	1
66371	66372	66373	38521	38522	38523	55261	55262	55263	22.0-1.50	4	D6	1
66381	66382	66383	38531	38532	38533	55271	55272	55273	22.0-2.50	4	D7	1
66391	66392	66393	38541	38542	38543	55281	55282	55283	24.0-2.00	4	D7	1
61614	61669	61721	37931	37932	37933	54941	54942	54943	24.0-3.00	4	D8	1
66401	66402	66403	-----	-----	-----	55291	55292	55293	27.0-2.00	4	D7	1
61619	61671	61722	-----	-----	-----	54951	54952	54953	27.0-3.00	4	D8	1
66411	66412	66413	-----	-----	-----	55301	55302	55303	30.0-2.00	4	D7	1
61621	61672	61723	-----	-----	-----	54961	54962	54963	30.0-3.50	4	D9	1
66421	66422	66423	-----	-----	-----	55311	55312	55313	33.0-2.00	6	D7	1
61622	61673	61724	-----	-----	-----	54971	54972	54973	33.0-3.50	4	D9	1
66431	66432	66433	-----	-----	-----	55321	55322	55323	36.0-3.00	4	D8	1
61623	61674	61729	-----	-----	-----	54981	54982	54983	36.0-4.00	4	D9	1
66441	66442	66443	-----	-----	-----	55331	55332	55333	39.0-3.00	6	D8	1
61624	61679	61731	-----	-----	-----	54991	54992	54993	39.0-4.00	6	D9	1

PRODUCT TIPS

Tap Wrenches:

They come in two sizes, large & small. Make sure tap is securely locked in place by turning the hex head as tightly as possible with your fingers. Do not use a wrench to tighten.

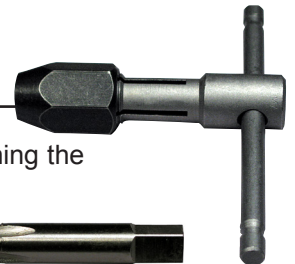

Taper Tap

This section cuts full-size thread



Plug Tap

This section cuts full-size thread



Bottoming Tap

This section cuts full-size thread

SETS STRAIGHT FLUTE TAP & TAPER PIPE TAPS

Straight Flute Hand Taps - Taper, Plug, Bottoming Ground Thread - High Speed Steel

- The most common style of tap
- Can be used by hand or for tapping under power
- Versatile taps for use in general machine tapping or CNC tapping applications
- Use for through hole or blind hole tapping

Type 35-AG - Gold Oxide

Gold Oxide - low temperature stress relief that enhances lubricity, reduces friction and increases tap toughness.

Type 35-AGN - Titanium Nitride

TiN coating increases wear resistance by producing a higher surface hardness and exceptional lubricity resulting in longer tool life.

Type 35 - Bright Finish

(Includes one each Taper, Plug and Bottoming tap)

35-AG Gold Oxide Part #	35-AGN TiN Coated Part #	Type 35 Bright Part #	Size	# of Flutes	PD Limit	Qty per/pck
61741	37744	54744	3.0-0.50	3	D3	1
61742	37764	54764	4.0-0.70	4	D4	1
61743	37784	54784	5.0-0.80	4	D4	1
61744	37794	54794	6.0-1.00	4	D5	1
61749	37804	54804	7.0-1.00	4	D5	1
61751	37814	54814	8.0-1.00	4	D5	1
61752	37824	54824	8.0-1.25	4	D5	1
61753	37834	54834	10.0-1.25	4	D5	1
61754	37844	54844	10.0-1.50	4	D6	1
61759	37854	54854	12.0-1.25	4	D5	1
61761	37864	54864	12.0-1.75	4	D6	1
61762	37874	54874	14.0-1.50	4	D6	1
61763	37884	54884	14.0-2.00	4	D6	1
61764	37894	54894	16.0-1.50	4	D6	1
61769	37904	54904	16.0-2.00	4	D7	1
61772	37914	54924	18.0-2.50	4	D7	1
61774	37924	54934	20.0-2.50	4	D7	1

TAPER PIPE TAPS

Regular - Type 30-AG, 30-AGN, 30-B & 30 Interrupted - Type I30-AG, I30-AGN, I30-B & I30

- **Regular** Thread NPT Taper Pipe taps are used for tapping pipe fittings and couplings in a wide variety of materials.
- **Interrupted** Thread Taper Pipe taps reduce friction, increase chip capacity, and enhance coolant flow. Recommended for a wide variety of materials including soft ductile materials that produce long stringy chips. (*Black Oxide Taper Pipe Tap used on Cast Iron)



Type 30-UB



Type I-30-UB Interrupted

NPT Regular				NPT INTERRUPTED				Size NPT	# of Flutes	Shank Diameter	Tap Drill Size	Qty. per/pack	
30-AG Gold Oxide Part #	30-AGN TiN Coated Part #	Type 30-B Black Part #	Type 30 Bright Part #	I30-AG Gold Oxide Part #	I30-AGN TiN Coated Part #	*I30-B Black Oxide Part #	I30 Bright Part #						
60570	59343	59342	59341	-----	-----	-----	-----	1/16-27	4	2-1/8"	.3125	D	3
61240	59353	59352	59351	-----	-----	-----	-----	1/8-27(5/16 Shk)	4	2-1/8"	.3125	11/32	3
61250	59363	59362	59361	81410	95722	95771	95770	1/8-27	4	2-1/8"	.4375	11/32	3
61260	59373	59372	59371	81420	95782	95781	95780	1/4-18	4	2-7/16"	.5625	7/16	3
61270	59383	59382	59381	81430	95792	95791	95790	3/8-18	4	2-9/16"	.7000	37/64	1
61280	59393	59392	59391	81440	95802	95801	95800	1/2-14	4	3-1/8"	.6875	23/32	1
61290	59403	59402	59401	81450	95812	95811	95810	3/4-14	5	3-1/4"	.9063	59/64	1
61300	59413	59412	59411	81460	95822	95821	95820	1" - 11 1/2	5	3-3/4"	1.1250	1-5/32	1
61310	59423	59422	59421	81470	95832	95831	95830	1 1/4" - 11 1/2	5	4"	1.3125	1-1/2	1
61320	59433	59432	59431	81480	95842	95841	95840	1 1/2" - 11 1/2	7	4-1/4"	1.5000	1-47/64	1
61330	59443	59442	59441	81490	95852	95851	95850	2" - 11 1/2	7	4-1/2"	1.8750	2-7/32	1

HIGH SPEED STEEL - EXTENSION TAPER PIPE TAPS - NPT

Type 30-EXT

- 6" OAL Extension NPT Pipe Tap
- High Speed Steel



Part #	# of Flutes	OAL	QTY. per/pack
77622	4	6	1
77632	4	6	1
77642	4	6	1
77652	4	6	1



STRAIGHT FLUTE TAPS - LEFT HAND THREAD

Type 23L-AG -Taper , Type 24L-AG -Plug , Type 25L-AG -Bottoming
Magnum Super Premium

- Special Hi-Tungsten and Hi-Molybdenum tool steels, gold surface treated for maximum lubricity.
- Taper, plug and bottoming styles provide great versatility in tough materials, both blind and through holes.
- For general use in production tapping or left hand tapping operations.



TYPE 23L-AG TAPER STYLE LEFT HAND THREAD

Part No.	Size	Number of Flutes	GH Limit	Qty. per/pack
60223	6-32	3	3	3
60243	8-32	4	3	3
60263	10-24	4	3	3
60273	10-32	4	3	3
60323	1/4-20	4	3	3
60333	1/4-28	4	3	3
60343	5/16-18	4	3	3
60353	5/16-24	4	3	3
60363	3/8-16	4	3	3
60373	3/8-24	4	3	3
60383	7/16-14	4	3	3
60393	7/16-20	4	3	3
60403	1/2-13	4	3	3
60413	1/2-20	4	3	3
60423	9/16-12	4	3	1
60433	9/16-18	4	3	1
60443	5/8-11	4	3	1
60453	5/8-18	4	3	1
60463	11/16-11	4	3	1
60473	11/16-16	4	3	1
60483	3/4-10	4	3	1
60493	3/4-16	4	3	1
60503	7/8-9	4	4	1
60513	7/8-14	4	4	1
60523	1-8	4	4	1
60533	1-12	4	4	1
60543	1-14	4	4	1
60553	1-1/8-7	4	4	1
60563	1-1/8-12	4	4	1
60573	1-1/4-7	4	4	1
60583	1-1/4-12	6	4	1
60593	1-3/8-6	4	4	1
60603	1-3/8-12	6	4	1
60613	1-1/2-6	6	4	1
60609	1-1/2-12	4	4	1

TYPE 24L-AG PLUG STYLE LEFT HAND THREAD

Part No.	Size	Number of Flutes	GH Limit	Qty. per/pack
60222	6-32	3	3	3
60242	8-32	4	3	3
60262	10-24	4	3	3
60272	10-32	4	3	3
60322	1/4-20	4	3	3
60332	1/4-28	4	3	3
60342	5/16-18	4	3	3
60352	5/16-24	4	3	3
60362	3/8-16	4	3	3
60372	3/8-24	4	3	3
60382	7/16-14	4	3	3
60392	7/16-20	4	3	3
60402	1/2-13	4	3	3
60412	1/2-20	4	3	3
60422	9/16-12	4	3	1
60432	9/16-18	4	3	1
60442	5/8-11	4	3	1
60452	5/8-18	4	3	1
60462	11/16-11	4	3	1
60472	11/16-16	4	3	1
60482	3/4-10	4	3	1
60492	3/4-16	4	3	1
60502	7/8-9	4	4	1
60512	7/8-14	4	4	1
60522	1-8	4	4	1
60532	1-12	4	4	1
60542	1-14	4	4	1
60552	1-1/8-7	4	4	1
60562	1-1/8-12	4	4	1
60572	1-1/4-7	4	4	1
60582	1-1/4-12	6	4	1
60592	1-3/8-6	4	4	1
60602	1-3/8-12	6	4	1
60612	1-1/2-6	4	4	1
60619	1-1/2-12	6	4	1

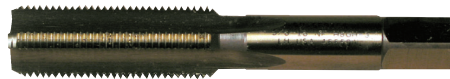

TYPE 25L-AG BOTTOMING LEFT HAND THREAD

Part No.	Size	Number of Flutes	GH Limit	Qty. per/pack	Part No.	Size	Number of Flutes	GH Limit	Qty. per/pack	Part No.	Size	Number of Flutes	GH Limit	Qty. per/pack
60224	6-32	3	3	3	60404	1/2-13	4	3	3	60524	1-8	4	4	1
60244	8-32	4	3	3	60414	1/2-20	4	3	3	60534	1-12	4	4	1
60264	10-24	4	3	3	60424	9/16-12	4	3	1	60544	1-14	4	4	1
60274	10-32	4	3	3	60434	9/16-18	4	3	1	60554	1-1/8-7	4	4	1
60324	1/4-20	4	3	3	60444	5/8-11	4	3	1	60564	1-1/8-12	4	4	1
60334	1/4-28	4	3	3	60454	5/8-18	4	3	1	60574	1-1/4-7	4	4	1
60344	5/16-18	4	3	3	60464	11/16-11	4	3	1	60584	1-1/4-12	6	4	1
60354	5/16-24	4	3	3	60474	11/16-16	4	3	1	60594	1-3/8-6	4	4	1
60364	3/8-16	4	3	3	60484	3/4-10	4	3	1	60604	1-3/8-12	6	4	1
60374	3/8-24	4	3	3	60494	3/4-16	4	3	1	60614	1-1/2-6	6	4	1
60384	7/16-14	4	3	3	60504	7/8-9	4	4	1	60599	1-1/2-12	4	4	1
60394	7/16-20	4	3	3	60514	7/8-14	4	4	1					

FRACTIONAL SPIRAL FLUTE SEMI-BOTTOMING TAPS

Right Hand Hi-Helix Flutes - Ground Thread - High Speed Steel

- Semi-bottoming style can be used for plug or bottoming applications.
- Helical flutes provides a shear cutting facilitating evacuation of chips from the hole.

30° Helix Angle - Used where chip disposal is a problem.

- Spiral flute design effectively draws chips out of the hole.

- Recommended when tapping blind or through holes in a variety of materials.

52° Helix Angle - Can be used for plug or bottoming applications.

- Allows for threading close to bottom or blind holes.

- Recommended for tapping deep holes in copper, brass, aluminum and other soft ductile materials



**Type 37-AGN - 52°
Titanium Nitride**



**Type 37 - 52°
Bright Finish**

Type 36-ACN 30°, 37-ACN 52° - Titanium Carbon Nitride

Titanium Carbon Nitride - coating raises cutting surface hardness greatly increasing resistance to wear.

Type 36-AGN 30°, 37-AGN 52° - Titanium Nitride

Titanium Nitride - coating adds lubricity and hardness, enhancing chip flow, finish hole quality and drill life.

Type 36 30°, Type 37 52° - Bright Finish

Bright Finish - Recommended in aluminum, zinc, copper, wood, refrigeration die casting, auto hardware and epoxy based plastics.

FRACTIONAL SPIRAL FLUTE SEMI-BOTTOMING TAPS - 30° SPIRAL

Type 36-ACN Titanium Carbon Nitride Part#	Type 36-AGN Titanium Nitride Part#	Type 36 Bright Part#	Spiral	Size	# of Flutes	H Limit	Qty. per/pack each
49804	49803	49802	30°	3-48	2	H2	1
49814	49813	49812	30°	3-56	2	H2	1
49824	49823	49822	30°	4-40	2	H2	1
49834	49833	49832	30°	4-48	2	H2	1
49844	49843	49842	30°	5-40	2	H2	1
49854	49853	49852	30°	5-44	2	H2	1
49864	49863	49862	30°	6-32	2	H3	1
49874	49873	49872	30°	6-40	2	H2	1
49884	49883	49882	30°	8-32	3	H3	1
49894	49893	49892	30°	8-36	3	H2	1
49904	49903	49902	30°	10-24	3	H3	1
49914	49913	49912	30°	10-32	3	H3	1
49924	49923	49922	30°	12-24	3	H3	1
49934	49933	49932	30°	12-28	3	H3	1
49944	49943	49942	30°	1/4-20	3	H3	1
49954	49953	49952	30°	1/4-28	3	H3	1
49964	49963	49962	30°	5/16-18	3	H3	1
49974	49973	49972	30°	5/16-24	3	H3	1
49984	49983	49982	30°	3/8-16	3	H3	1
49994	49993	49992	30°	3/8-24	3	H3	1
50004	50003	50002	30°	7/16-14	3	H3	1
50014	50013	50012	30°	7/16-20	3	H3	1
50024	50023	50022	30°	1/2-13	3	H3	1
50034	50033	50032	30°	1/2-20	3	H3	1
50044	50043	50042	30°	9/16-12	4	H3	1
50054	50053	50052	30°	9/16-18	4	H3	1
50064	50063	50062	30°	5/8-11	4	H3	1
50074	50073	50072	30°	5/8-18	4	H3	1
50084	50083	50082	30°	3/4-10	4	H3	1
50094	50093	50092	30°	3/4-16	4	H3	1

FRACTIONAL SPIRAL FLUTE SEMI-BOTTOMING TAPS - 52° SPIRAL

Type 37-ACN Titanium Carbon Nitride Part#	Type 37-AGN Titanium Nitride Part#	Type 37 Bright Part#	Spiral	Size	# of Flutes	H Limit	Qty. per/pack each
52854	52853	52852	52°	3-48	2	H2	1
52864	52863	52862	52°	3-56	2	H2	1
52874	52873	52872	52°	4-40	2	H2	1
52884	52883	52882	52°	4-48	2	H2	1
52894	52893	52892	52°	5-40	2	H2	1
52904	52903	52902	52°	5-44	2	H2	1
52914	52913	52912	52°	6-32	2	H3	1
52924	52923	52922	52°	6-40	2	H2	1
52934	52933	52932	52°	8-32	3	H3	1

Continued on next page

HSS Taps

FRACTIONAL / METRIC SPIRAL FLUTE SEMI-BOTTOMING TAPS

Right Hand Hi-Helix Flutes Ground Thread - High Speed Steel

- Semi-bottoming style can be used for plug or bottoming applications.
- Helical flutes provides a shear cutting facilitating evacuation of chips from the hole.

30° Helix Angle - *Used where chip disposal is a problem.*

• *Spiral flute design effectively draws chips out of the hole.*

• **Recommended** when tapping blind or through holes in a variety of materials.

52° Helix Angle - *Can be used for plug or bottoming applications.*

• *Allows for threading close to bottom or blind holes.*

• **Recommended** for tapping deep holes in copper, brass, aluminum and other soft ductile materials.



**Type 37-AGN - 52°
Titanium Nitride**



**Type 37- 52°
Bright Finish**

Type 37-ACN 52°, Metric Type 38-ACN 30°, Metric 39-ACN 52° - Titanium Carbon Nitride

Titanium Carbon Nitride - coating raises cutting surface hardness greatly increasing resistance to wear.

Type 37-AGN 52°, Metric 38-AGN 30°, Metric 39-AGN 52° - Titanium Nitride

Titanium Nitride - coating adds lubricity and hardness, enhancing chip flow, finish hole quality and drill life.

Type 37 52°, Metric Type 38 30°, Metric Type 39 52° - Bright Finish

Bright Finish - Recommended in aluminum, zinc, copper, wood, refrigeration die casting, auto hardware and epoxy based plastics.

FRACTIONAL - SPIRAL FLUTE SEMI-BOTTOMING TAPS - 52° SPIRAL

Type 37-ACN Titanium Carbon Nitride Part #	Type 37-AGN Titanium Nitride Part #	Type 37 Bright Part #	Spiral	Size	# of Flutes	H Limit	Qty. per/pack each
52944	52943	52942	52°	8-36	3	H2	1
52954	52953	52952	52°	10-24	3	H3	1
52964	52963	52962	52°	10-32	3	H3	1
52974	52973	52972	52°	12-24	3	H3	1
52984	52983	52982	52°	12-28	3	H3	1
52994	52993	52992	52°	1/4-20	3	H3	1
53004	53003	53002	52°	1/4-28	3	H3	1
53014	53013	53012	52°	5/16-18	3	H3	1
53024	53023	53022	52°	5/16-24	3	H3	1
53034	53033	53032	52°	3/8-16	3	H3	1
53044	53043	53042	52°	3/8-24	3	H3	1
53054	53053	53052	52°	7/16-14	3	H3	1
53064	53063	53062	52°	7/16-20	3	H3	1
53074	53073	53072	52°	1/2-13	3	H3	1
53084	53083	53082	52°	1/2-20	3	H3	1
53094	53093	53092	52°	9/16-12	4	H3	1
53104	53103	53102	52°	9/16-18	4	H3	1
53114	53113	53112	52°	5/8-11	4	H3	1
53124	53123	53122	52°	5/8-18	4	H3	1
53134	53133	53132	52°	3/4-10	4	H3	1
53144	53143	53142	52°	3/4-16	4	H3	1

METRIC

SPIRAL FLUTE SEMI-BOTTOMING TAPS - 30° SPIRAL

Type 38-ACN Titanium Carbon Nitride Part #	Type 38-AGN Titanium Nitride Part #	Type 38 Bright Part #	Spiral	Size	# of Flutes	D Limit	Qty. per/pack each
69014	69013	69012	30°	3.00 x .50	2	D3	1
69024	69023	69022	30°	3.50 x .60	2	D4	1
69034	69033	69032	30°	4.00 x .70	3	D4	1
69044	69043	69042	30°	4.50 x .75	3	D4	1
69054	69053	69052	30°	5.00 x .80	3	D4	1
69064	69063	69062	30°	6.00 x 1.00	3	D5	1
69074	69073	69072	30°	8.00 x 1.25	3	D5	1
69084	69083	69082	30°	10.00 x 1.50	3	D6	1
69094	69093	69092	30°	12.00 x 1.75	3	D6	1

METRIC

SPIRAL FLUTE SEMI-BOTTOMING TAPS - 52° SPIRAL

Type 39-ACN Titanium Carbon Nitride Part #	Type 39-AGN Titanium Nitride Part #	Type 39 Bright Part #	Spiral	Size	# of Flutes	D Limit	Qty. per/pack each
69314	69313	69312	52°	3.00 x .50	2	D3	1
69324	69323	69322	52°	3.50 x .60	2	D4	1
69334	69333	69332	52°	4.00 x .70	3	D4	1
69344	69343	69342	52°	4.50 x .75	3	D4	1
69354	69353	69352	52°	5.00 x .80	3	D4	1
69364	69363	69362	52°	6.00 x 1.00	3	D5	1
69374	69373	69372	52°	8.00 x 1.25	3	D5	1
69384	69383	69382	52°	10.00 x 1.50	3	D6	1
69394	69393	69392	52°	12.00 x 1.75	3	D6	1

DRILL & TAP COMBO & SETS

Magnum Super Premium

Includes corresponding drill with tap in a durable metal case

SP-18TD



TAP & DRILL SETS

SP-18TD (SPIRAL POINT, NC)

Part#	Description of Sizes
190-AG Drill Sizes	#36, 29, 25, 21, 7, F, 5/16, U & 27/64
20-AG Tap Sizes	6-32, 8-32, 10-24, 10-32, 1/4-20 & 5/16-18, 3/8-16, 7/16-14 & 1/2-13

SP-18TDM (SPIRAL POINT, METRIC)

Part#	Description of Sizes
170-AG Drill Sizes (mm)	2.05, 2.50, 2.90, 3.30, 4.20, 5.00, 6.70, 8.50 & 10.20
21-AG Tap Sizes (mm)	2.5-.45, 3.0-.50, 3.5-.60, 4.0-.70, 5.0-.80, 6.0-1.00, 8.0-1.25, 10.0-1.50 & 12.0-1.75

SP-18TDF (SPIRAL POINT, NF)

Part#	Description of Sizes
190-AG Drill Sizes	#33, 29, 25, 21, 3, 1, Q, 25/64 & 29/64
20-AG Tap Sizes	6-40, 8-36, 10-24, 10-32, 1/4-28, 5/16-24, 3/8-24, 7/16-20 & 1/2-20

SP-12TD (SPIRAL POINT, NC)

Part#	Description of Sizes
190-AG Drill Sizes	#36, 29, 25, 21, 7, F
20-AG Tap Sizes	6-32, 8-32, 10-24, 10-32, 1/4-20 & 5/16-18

SF-18TDC (STRAIGHT FLUTE, NC)

Part#	Description of Sizes
190-AG Drill Sizes	#36, 29, 25, 21, 7, F, 5/16, U & 27/64
24-AG Tap Sizes	6-32, 8-32, 10-24, 10-32, 1/4-20, 5/16-18, 3/8-16, 7/16-14 & 1/2-13

SF-18TDF (STRAIGHT FLUTE, NF)

Part#	Description of Sizes
190-AG Drill Sizes	#33, 29, 25, 21, 3, 1, Q, 25/64 & 29/64
24-AG Tap Sizes	6-40, 8-36, 10-24, 10-32, 1/4-28, 5/16-24, 3/8-24, 7/16-20 & 1/2-20

SF-10TD (STRAIGHT FLUTE, NC)

Part#	Description of Sizes
190-AG Drill Size	31/64
130-AG Drill Sizes	17/32, 21/32, 49/64 & 7/8
24-AG Tap Sizes	9/16-12, 5/8-11, 3/4-10, 7/8-9 & 1-8

B-18TD BRIGHT FINISH 118° POINT - DRILL & TAP COMBO SET

Part#	Description of Sizes
Type 100 Drill Sizes	#36, 29, 25, 21, 7, F, 5/16, U & 27/64
Type 20 Tap Sizes	6-32, 8-32, 10-24, 10-32, 1/4-20 7/5/16-18, 3/8-16, 7/16-14 & 1/2-13

DRILL & TAP COMBO

Type 34-AG

- Includes the correct drill with corresponding size tap on a hanging card.
- Both tools are gold surface treated for maximum lubricity, and precision ground for the ultimate in accuracy and performance.
- Hi-Molybdenum super premium twist drill combined with the corresponding Hi-Tungsten Magnum spiral point tap.

Part No.	Thread Size	Drill Size	Part No.	Thread Size	Drill Size
51807	6-32	36	51897	1/4-28	3
51817	6-40	33	51907	5/16-18	F
51827	8-32	29	51917	5/16-24	I
51837	8-36	29	51927	3/8-16	5/16
51847	10-24	25	51937	3/8-24	Q
51857	10-32	21	51947	7/16-14	U
51867	12-24	16	51957	7/16-20	25/64
51877	12-28	14	51967	1/2-13	27/64
51887	1/4-20	7	51977	1/2-20	29/64

COMBINATION DRILL & TAP

Type 40-AG

- Hi-Molybdenum tool steel ensures longer tool life.
- Combination drill and taps are ideally suited for on-site tapping in construction, maintenance and repair, assembly, production environments.
- The self-centering split point provides excellent drilling precision and accuracy.



Pitch Diameter and Thread tolerances are designed to produce a Class 2B fit.

Part #	Size	Max Material Thickness	Thread Length
73770	4-40	0.368	0.564
73780	4-48	0.369	0.564
73790	5-40	0.403	0.624
73800	5-44	0.404	0.624
73810	6-32	0.468	0.376
73820	6-40	0.470	0.376
73830	8-32	0.539	0.376
73840	8-36	0.540	0.376
73850	10-24	0.606	0.496
73860	10-32	0.608	0.496
73870	12-24	0.677	0.496
73880	12-28	0.678	0.496
73890	1/4-20	0.746	0.626
73900	1/4-28	0.750	0.626
73910	5/16-18	0.889	0.683
73920	5/16-24	0.893	0.683
73930	3/8-16	1.031	0.746
73940	3/8-24	1.036	0.746
73950	7/16-14	1.172	0.882
73960	7/16-20	1.178	0.880
73970	1/2-13	1.378	0.940
73980	1/2-20	1.384	0.940
75540	9/16-12	1.395	0.940
75550	9/16-18	1.403	0.940
75560	5/8-11	1.412	0.940
75570	5/8-18	1.421	0.940

Pitch Diameter and Thread tolerances are designed to produce a Class 6H fit.

Part #	MM Size	Max Material Thickness	Thread Length
85921	3.0 x 0.5	0.403	0.624
85931	4.0 x 0.7	0.538	0.376
85941	5.0 x 0.8	0.610	0.496
85951	6.0 x 1.00	0.746	0.626
85961	7.0 x 1.00	0.882	0.686
85971	8.0 x 1.25	0.892	0.686
85991	10.0 x 1.50	1.037	0.746
86001	12.0 x 1.75	1.373	0.942

Part#	SETS	Description of Sizes
21330	40-AG - DT-6	6pc. set 6-32, 8-32, 10-24, 10-32, 12-24, 1/4-20
73991	40-AG - DT-7F	7pc. set 8-36, 10-32, 1/4-28, 5/16-24, 3/8-24, 7/16-20, 1/2-20
73990	40-AG - DT-7C	7pc. set 8-32, 10-24, 1/4-20, 5/16-18, 3/8-16, 7/16-14, 1/2-13

1/4" QUICK RELEASE DRILL & TAP COMBO

Type 40-QR



Split Point

- Hi-Molybdenum tool steel ensures longer tool life.
- Combination drill and taps are ideally suited for on-site tapping in construction, maintenance and repair, assembly, production environments.



Pitch Diameter and Thread tolerances are designed to produce a Class 2B fit.

Part#	Size	Max Material Thickness	Thread Length
73814	6-32	0.170	0.283
73834	8-32	0.200	0.283
73854	10-24	0.200	0.363
73864	10-32	0.200	0.363
73874	12-24	0.200	0.369
73894	1/4-20	0.230	0.326
73904	1/4-28	0.230	0.326
73914	5/16-18	0.480	0.614
73934	3/8-16	0.480	0.585

Pitch Diameter and Thread tolerances are designed to produce a Class 6H fit.

Part #	MM Size	Max Material Thickness	Thread Length
85924	3.0 x 0.50	0.170	0.334
85934	4.0 x 0.70	0.170	0.269
85944	5.0 x 0.80	0.200	0.404
85954	6.0 x 1.00	0.230	0.376
85974	8.0 x 1.25	0.480	0.638
85994	10.0 x 1.50	0.480	0.595

Part#	SET	Description of Sizes
21324	40-QR DT-5	5pc. set 6-32, 8-32, 10-24, 10-32, 1/4-20

HSS Taps & Dies

HSS TAP SETS, HEX DIES - METRIC & CARDED HANGING DISPLAY

Carded Hanging Display

38 Piece MRO Pro-Pack Drilling & Tapping Combo Carded Super Premium Black & Gold Twist Drill combined with the Corresponding Hi-Tungsten Spiral Point Gold Tap.

Part No. 52001

One Each of	Two Each of	Three Each of	Four Each of
6-32	8-32	5/16-18	1/4-20
6-40	8-36	3/8-16	
12-24	10-24	7/16-14	
12-28	10-32	1/2-13	
	1/4-28		
	5/16-24		
	3/8-24		
	7/16-20		
	1/2-20		

HSS TAP SETS

Magnum Super Premium

- Straight flute or spiral point taps in rugged black steel index.



SPIRAL & STRAIGHT FLUTE TAP SETS

SP-19T - Type 20-AG - Spiral Point

Part No. Sizes

61600 0-80, 1-64, 1-72, 2-56, 2-64, 3-48, 3-56, 4-40 4-48, 5-40, 5-44, 6-32, 6-40, 8-32, 8-36, 10-24, 10-32, 12-24 & 12-28

SP-10T - Type 20-AG - Spiral Point

Part No. Sizes

61610 1/4-20, 1/4-28, 5/16-18, 5/16-24, 3/8-16, 3/8-24, 7/16-14, 7/16-20, 1/2-13 & 1/2-20

SF-10T - Type 24-AG - Straight Flute

Part No. Sizes

61620 1/4-20, 1/4-28, 5/16-18, 5/16-24, 3/8-16, 3/8-24, 7/16-14, 7/16-20, 1/2-13 & 1/2-20

HIGH-SPEED STEEL HEX DIES

Type 27-AG

Magnum Super Premium Dies

- Special Hi-Molybdenum tool steel, polished gold finish with black surface treated threads for long life and rich appearance.
- These dies are used for threading rods, bolts, studs and other pieces requiring external threads.
- The outside hex configuration allows both wrench and die stock use in threading.



Part No.	Size	Across Flats	Qty. per/pack
61000	4-40	1"	3
61010	6-32	1"	3
61020	8-32	1"	3
61030	10-24	1"	3
61040	10-32	1"	3
61050	12-24	1"	3
61060	1/4-20	1"	3
61070	1/4-28	1"	3
61080	5/16-18	1"	3
61090	5/16-24	1"	3
61100	3/8-16	1"	3
61110	3/8-24	1"	3
61120	7/16-14	1"	3
61130	7/16-20	1"	3
61140	1/2-13	1"	3
61150	1/2-20	1"	3
61160	9/16-12	1-7/16"	1
61170	9/16-18	1-7/16"	1
61180	5/8-11	1-7/16"	1
61190	5/8-18	1-7/16"	1
61200	3/4-10	1-7/16"	1
61210	3/4-16	1-7/16"	1
61220	1/8-27	1"	1
61230	1/4-18	1-7/16"	1

METRIC

Part No.	Size	Across Flats	Qty. per/pack
60511	3.0 x 0.50	1"	3
60521	3.5 x 0.60	1"	3
60531	4.0 x 0.70	1"	3
60551	5.0 x 0.80	1"	3
60561	6.0 x 1.00	1"	3
60581	8.0 x 1.25	1"	3
60601	10.0 x 1.50	1"	3
60621	12.0 x 1.75	1-7/16"	1
60622	14.0 x 1.50	1-7/16"	1

25PC / 23PC / 15PC / 14PC HSS TAP & DIE ASSORTMENTS

25pc. Magnum Super Premium Set Spiral point Plug Taps & Hex Dies

Set contains: Type 20-AG and 27-AG

- HSS spiral point taps & HSS hex dies sizes: 1/4-20, 1/4-28, 5/16-18, 5/16-24, 3/8-16, 3/8-24, 7/16-14, 7/16-20, 1/2-13 & 1/2-20
- HSS pipe tap and hex die size: 1/8-27 NPT.
- T-Handle tap wrench: 3/16" - 1/2"
- Die stock & Screw pitch gauge
- SP-25TDI

Supplied in sturdy plastic case

PART NO. 35173



Part # 35173

24pc. Magnum Super Premium Set - Metric Spiral point Taps & Hex Dies

Set contains: Type 21-AG and 27-AG

- HSS spiral point taps & HSS hex dies sizes: 3.0-.50, 3.5-.60, 4.0-.70, 5.0-.80, 6.0-1.00, 8.0-1.25, 10.0-1.50 & 12.0-1.75
- HSS pipe tap and hex die size: 1/8-27 NPT
- T-Handle tap wrenches: 0 - 1/4" & 3/16" - 1/2"
- Straight handle tap wrench: #4 - 1/2"
- Die stock & Screw metric pitch gauge
- SP-23TDI

Supplied in sturdy plastic case

PART NO. 35170

15pc. Magnum Super Premium Set Spiral point Plug Taps & Hex Dies

Set contains: Type 20-AG and 27-AG

- HSS spiral point taps & HSS hex dies sizes: 6-32, 8-32, 10-24, 10-32, 12-24 & 1/4-20
- T-Handle tap wrench: 0 - 1/4"
- Economy die stock & Screw pitch gauge
- SP-15TDI

Supplied in sturdy plastic case

PART NO. 35174

14pc. Magnum Super Premium Set - Metric Spiral point Taps & Hex Dies

Set contains: Type 21-AG and 27-AG

- HSS spiral point taps sizes: 2.5-.45, 3.0-.50, 3.5-.60, 4.0-.70, 5.0-.80 & 6.0-1.00.
- HSS hex dies sizes: 3.0-.50, 3.5-.60, 4.0-.70, 5.0-.80 & 6.0-1.00.
- T-Handle tap wrench: 0 - 1/4".
- SP-14TDI

Economy die stock & Screw metric pitch gauge.

Supplied in sturdy plastic case.

PART NO. 35172

58 PC & 40 PC HSS TAPS & DIE ASSORTMENTS

- Special Hi -Tungsten and Hi -Molybdenum tool steels, gold oxide for maximum lubricity.
- Recommended for use in production tapping and drilling in work hardening grades of stainless steel and other hard metal applications.
- Precision ground tap threads for the ultimate in accuracy and performance.



Part # 61680

58pc. Magnum Super Premium Set Straight Flute Plug Taps & Hex Dies

Set contains: Type 24-AG and 27-AG

- HSS straight flute taps & HSS hex dies sizes: 6-32, 8-32, 10-24, 10-32, 12-24, 1/4-20, 1/4-28, 5/16-18, 5/16-24, 3/8-16, 3/8-24, 7/16-14, 7/16-20, 1/2-13, 1/2-20, 9/16-12, 9/16-18, 5/8-11, 5/8-18, 3/4-10, 3/4-16, 1/8-27NPT & 1/4-18NPT
- Straight handle tap wrenches: #4-1/2" & 1/4" - 3/4"
 - Die stocks: MED R/H & 1" R/H
 - T-handle tap wrench: 0 - 1/4"
 - Screw pitch gauge
- Screw driver & Spiral flute extractors sizes: Ex 1 thru Ex 5
 - SF-58TDI

Supplied in sturdy plastic case

PART NO. 61680

40pc. Magnum Super Premium Set Straight Flute Plug Taps & Hex Dies

Set contains: Type 24-AG and 27-AG

- HSS straight flute taps & HSS hex dies sizes: 4-40, 6-32, 8-32, 10-24, 10-32, 12-24, 1/4-20, 1/4-28, 5/16-18, 5/16-24, 3/8-16, 3/8-24, 7/16-14, 7/16-20, 1/2-13 & 1/2-20.
 - HSS pipe tap and hex die size: 1/8-27 NPT
- T-Handle tap wrenches: 0 - 1/4" & 3/16" - 1/2"
 - Straight handle tap wrench: #4 - 1/2"
- Die stock, Screw pitch gauge & Screw driver
 - SF-40TDI

Supplied in sturdy plastic case

PART NO. 35171



Part # 35171

40pc. Magnum Super Premium Set Spiral point Plug Taps & Hex Dies

Set contains: Type 20-AG and 27-AG

- HSS spiral point taps & HSS hex dies sizes: 4-40, 6-32, 8-32, 10-24, 10-32, 12-24, 1/4-20, 1/4-28, 5/16-18, 5/16-24, 3/8-16, 3/8-24, 7/16-14, 7/16-20, 1/2-13 & 1/2-20
 - HSS pipe tap and hex die size: 1/8-27 NPT
- T-Handle tap wrenches: 0 - 1/4" & 3/16" - 1/2"
 - Straight handle tap wrench: #4 - 1/2"
- Die stock, Screw pitch gauge & Screw driver
 - SP-40TDI

Supplied in sturdy plastic case

PART NO. 35181

Hi-Carbon Steel Taps

HI-CARBON STEEL TAPS - U.S. SIZES (PLUG & TAPER)

Type 720 Plug Fractional , Type 721 Plug Machine Screw

Type 740 Taper Fractional , Type 741 Taper Machine Screw

- Made of super tough carbon steel, these taps are ideal for hand tapping and re-threading applications.



Plug - Type 721



Taper-Type 741

TYPE 720 -PLUG FRACTIONAL

Part No.	Size	Tap Drill Size	No. of Flutes	Qty. per/pack
55010	3/16x24	26	4	3
55020	3/16x32	22	4	3
55030	1/4x20	7	4	3
55040	1/4x28	3	4	3
55050	5/16x18	17/64	4	3
55060	5/16x24	17/64	4	3
55070	3/8x16	5/16	4	3
55080	3/8x24	21/64	4	3
55090	7/16x14	3/8	4	3
55100	7/16x20	25/64	4	3
55110	1/2x13	27/64	4	3
55120	1/2x20	29/64	4	3
55130	9/16x12	31/64	4	1
55140	9/16x18	33/64	4	1
55150	5/8x11	17/32	4	1
55720	5/8x18	37/64	4	1
55730	11/16x11	19/32	4	1
55740	11/16x16	5/8	4	1
55160	3/4x10	21/32	4	1
55890	3/4x16	11/16	4	1
55170	7/8x9	49/64	4	1
55180	7/8x14	13/16	4	1
55190	1x8	7/8	4	1
55200	1x12	29/32	4	1
55210	1x14	15/16	4	1

TYPE 740 -TAPER FRACTIONAL

Part No.	Size	Tap Drill Size	No. of Flutes	Qty. per/pack
55250	3/16x24	26	4	3
55260	3/16x32	22	4	3
55270	1/4x20	7	4	3
55280	1/4x28	3	4	3
55290	5/16x18	17/64	4	3
55300	5/16x24	17/64	4	3
55310	3/8x16	5/16	4	3
55320	3/8x24	21/64	4	3
55330	7/16x14	3/8	4	3
55340	7/16x20	25/64	4	3
55350	1/2x13	27/64	4	3
55360	1/2x20	29/64	4	3
55370	9/16x12	31/64	4	1
55380	9/16x18	33/64	4	1
55390	5/8x11	17/32	4	1
55460	5/8x18	37/64	4	1
55470	11/16x11	19/32	4	1
55480	11/16x16	5/8	4	1
55400	3/4x10	21/32	4	1
55710	3/4x16	11/16	4	1
55410	7/8x9	49/64	4	1
55420	7/8x14	13/16	4	1
55430	1x8	7/8	4	1
55440	1x12	29/32	4	1
55450	1x14	15/16	4	1

TYPE 721 -PLUG MACHINE SCREW

Part No.	Size	Tap Drill Size	No. of Flutes	Qty. per/pack
54860	0x80	3/64	3	3
54870	1x64	53	3	3
54880	1x72	53	3	3
54890	2x56	50	3	3
54900	2x64	50	3	3
54910	3x48	47	3	3
54920	3x56	46	3	3
55750	4x36	43	3	3
55760	4x40	44	3	3
55770	5x40	38	3	3
55780	6x32	36	3	3
55790	6x40	34	3	3
55800	6x48	32	3	3
55810	8x32	29	3	3
55820	8x36	29	3	3
55830	8x40	28	3	3
55840	10x24	25	3	3
55850	10x32	21	3	3
55860	12x24	16	3	3
55870	12x28	16	3	3
55880	14x20	10	3	3

TYPE 741 -TAPER MACHINE SCREW

Part No.	Size	Tap Drill Size	No. of Flutes	Qty. per/pack
54790	0X80	3/64	3	3
54800	1X64	53	3	3
54810	1X72	53	3	3
54820	2X56	50	3	3
54830	2X64	50	3	3
54840	3X48	47	3	3
54850	3X56	46	3	3
55900	4x36	43	3	3
55910	4x40	44	3	3
55920	5x40	38	3	3
55930	6x32	36	3	3
55940	6x40	34	3	3
55950	6x48	32	3	3
55960	8x32	29	3	3
55970	8x36	29	3	3
55980	8x40	28	3	3
55990	10x24	25	3	3
56000	10x32	21	3	3
56010	12x24	16	3	3
56020	12x28	16	3	3
56030	14x20	10	3	3

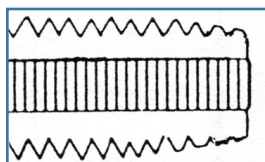

PLUG - Type 720 & 721

Three to five threads chamfered. For general use when tapping into the bottom of the hole is not critical. (This is the most widely used style.)

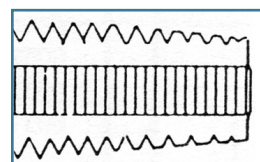

TAPER - Type 740 & 741

Seven to ten threads chamfered for easy use thread starting in tough materials.

Hi-Carbon Steel Taps

HI-CARBON STEEL TAPS - U.S. SIZES (BOTTOMING & 3 Piece SETS)

Type 760 -Bottoming -Fractional, Type 761 -Bottoming -Machine Screw
 Type 722 -3 pcs. Sets -Fractional, Type 723 -3 pcs. Sets -Machine Screw



Bottoming - Type 761

TYPE 760 BOTTOMING FRACTIONAL

Part No.	Size	Tap Drill Size	No. of Flutes	Qty. per/pack
55500	3/16x24	26	4	3
55510	3/16x32	22	4	3
55520	1/4x20	7	4	3
55530	1/4x28	3	4	3
55540	5/16x18	17/64	4	3
55550	5/16x24	17/64	4	3
55560	3/8x16	5/16	4	3
55570	3/8x24	21/64	4	3
55580	7/16x14	3/8	4	3
55590	7/16x20	25/64	4	3
55600	1/2x13	27/64	4	3
55610	1/2x20	29/64	4	3
55620	9/16x12	31/64	4	1
55630	9/16x18	33/64	4	1
55640	5/8x11	17/32	4	1
56040	5/8x18	37/64	4	1
56050	11/16x11	19/32	4	1
56060	11/16x16	5/8	4	1
55650	3/4x10	21/32	4	1
56070	3/4x16	11/16	4	1
55660	7/8x9	49/64	4	1
55670	7/8x14	13/16	4	1
55680	1x8	7/8	4	1
55690	1x12	29/32	4	1
55700	1x14	15/16	4	1

These items are also available carded. See Price List Catalog for details.

3 PC. SETS TYPE 722 FRACTIONAL

Part No.	Size	Tap Drill Size	No. of Flutes	Qty. per/pack
56300	3/16x24	26	4	1
56310	3/16x32	22	4	1
56320	1/4x20	7	4	1
56330	1/4x28	3	4	1
56340	5/16x18	17/64	4	1
56350	5/16x24	17/64	4	1
56360	3/8x16	5/16	4	1
56370	3/8x24	21/64	4	1
56380	7/16x14	3/8	4	1
56390	7/16x20	25/64	4	1
56400	1/2x13	27/64	4	1
56410	1/2x20	29/64	4	1
56420	9/16x12	31/64	4	1
56430	9/16x18	33/64	4	1
56440	5/8x11	17/32	4	1
56590	5/8x18	37/64	4	1
56740	11/16x11	19/32	4	1
56750	11/16x16	5/8	4	1
56450	3/4x10	21/32	4	1
56760	3/4x16	11/16	4	1
56460	7/8x9	49/64	4	1
56470	7/8x14	13/16	4	1
56480	1x8	7/8	4	1
56490	1x12	29/32	4	1
56500	1x14	15/16	4	1

Includes one of each same size Taper, Plug and Bottoming taps.

TYPE 761 BOTTOMING - MACHINE SCREW

Part No.	Size	Tap Drill Size	No. of Flutes	Qty. per/pack
54930	0x80	3/64	3	3
54940	1x64	53	3	3
54950	1x72	53	3	3
54960	2x56	50	3	3
54970	2x64	50	3	3
54980	3x48	47	3	3
54990	3x56	46	3	3
56100	4x36	43	3	3
56110	4x40	44	3	3
56120	5x40	38	3	3
56130	6x32	36	3	3
56140	6x40	34	3	3
56150	6x48	32	3	3
56160	8x32	29	4	3
56170	8x36	29	4	3
56180	8x40	28	4	3
56190	10x24	25	4	3
56200	10x32	21	4	3
56210	12x24	16	4	3
56220	12x28	16	4	3
56230	14x20	10	4	3

These items are also available carded. See Price List Catalog for details.

3 PC. SETS TYPE 723 MACHINE SCREW

Part No.	Size	Tap Drill Size	No. of Flutes	Qty. per/pack
56600	4x36	43	3	1
56610	4x40	44	3	1
56620	5x40	38	3	1
56630	6x32	36	3	1
56640	6x40	34	3	1
56650	6x48	32	3	1
56660	8x32	29	4	1
56670	8x36	29	4	1
56680	8x40	28	4	1
56690	10x24	25	4	1
56700	10x32	21	4	1
56710	12x24	16	4	1
56720	12x28	16	4	1
56730	14x20	10	4	1

Includes one of each same size Taper, Plug and Bottoming taps.

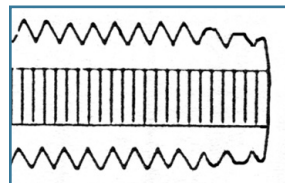

BOTTOMING Type 760 & 761

One to Two threads chamfered. To use after threads have been started for tapping to the bottom of a hole.

Hi-Carbon Steel Dies

HI-CARBON STEEL DIES - HEX DIES

Type 405 - Machine Screw & Fractional sizes, Type 790 -Metric

- These dies are made of high quality carbon tool steel and meet the highest industry standards.
- A complete selection of solid round, adjustable round, and solid hex dies for right hand threads is available.
- Select sizes of dies may be imported.

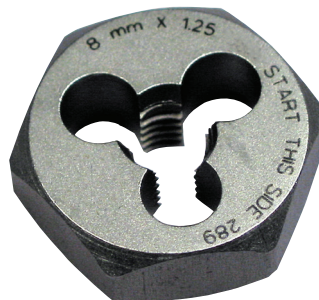

TYPE 405 MACHINE SCREW & FRACTIONAL SIZES

Part No.	Size	Across Flats	Qty. per/pack
86000	4x40	1"	3
86010	4x36	1"	3
86020	5x40	1"	3
86030	6x32	1"	3
86040	8x32	1"	3
86050	10x24	1"	3
86060	10x32	1"	3
86070	12x24	1"	3
86080	14x20	1"	3
86100	3/16x24	1"	3
86110	3/16x32	1"	3
86120	1/4x20	1"	3
86130	1/4x28	1"	3
86140	5/16x18	1"	3
86150	5/16x24	1"	3
86160	3/8x16	1"	3
86170	3/8x24	1"	3
86180	7/16x14	1"	3
86190	7/16x20	1"	3
86200	1/2x13	1"	3
86210	1/2x20	1"	3
86220	9/16x12	1-7/16"	1
86230	9/16x18	1-7/16"	1
86240	5/8x11	1-7/16"	1
86250	5/8x18	1-7/16"	1
86260	11/16x11	1-7/16"	1
86270	11/16x16	1-7/16"	1
86280	3/4x10	1-7/16"	1
86290	3/4x16	1-7/16"	1
86300	7/8x9	1-5/8"	1
86310	7/8x14	1-5/8"	1
86320	1x8	1-13/16"	1
86330	1x12	1-13/16"	1
86340	1x14	1-13/16"	1
86350	1/8x27	1"	1
86360	1/4x18	1"	1
86380	3/8x18	1-7/16"	1
86390	1/2x14	1-5/8"	1
86420	3/4x14	2"	1
86430	1-11x1/2"	2-3/8"	1

TYPE 790 METRIC SIZES

Part No.	Size	Across Flats	Qty. per/pack
84000	3x.50	1"	3
84010	3x.60	1"	3
84020	4x.70	1"	3
84030	4x.75	1"	3
84040	5x.80	1"	3
84050	5x.90	1"	3
84060	6x1.00	1"	3
84070	7x1.00	1"	3
84270	8x1.00	1"	3
84080	8x1.25	1"	3
84090	9x1.00	1"	3
84100	9x1.25	1"	3
84110	10x1.00	1"	3
84120	10x1.25	1"	3
84130	10x1.50	1"	3
84140	11x1.50	1"	3
84280	12x1.25	1"	3
84150	12x1.50	1"	3
84160	12x1.75	1"	3
84170	14x1.25	1-7/16"	1
84290	14x1.50	1-7/16"	1
84180	14x2.00	1-7/16"	1
84190	16x1.50	1-7/16"	1
84200	16x2.00	1-7/16"	1
84210	18x1.50	1-7/16"	1
84300	18x2.00	1-7/16"	1
84220	18x2.50	1-7/16"	1

These items are also available carded.
See Price List Catalog for details.

HEXAGONAL DIES: TIPS

Carbon steel dies are primarily used for restoring damaged threads. Hex shape allows them to be driven in cramped quarters with a wrench.

HI-CARBON STEEL DIES - ADJUSTABLE & ROUND

Type 415 -Adjustable , Type 400 -Round

- These dies are made of high quality carbon tool steel and meet the highest industry standards.
- We offer a complete selection of solid round and adjustable round for right hand threads.
- Select sizes of dies may be imported.

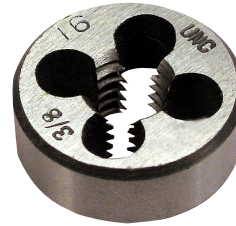

TYPE 415 -ADJUSTABLE MACHINE SCREW & FRACTIONAL

Part No.	Size	O.D.	Qty. per/pack
85000	0x80	1"	3
85010	1x64	1"	3
85020	1x72	1"	3
85030	2x56	1"	3
85040	2x64	1"	3
85050	3x48	1"	3
85060	3x56	1"	3
85070	4x40	1"	3
85080	4x36	1"	3
85090	5x40	1"	3
85100	6x32	1"	3
85110	8x32	1"	3
85120	10x24	1"	3
85130	10x32	1"	3
85140	12x24	1"	3
85150	14x20	1"	3
85170	3/16x24	1"	3
85180	3/16x32	1"	3
85190	1/4x20	1"	3
85200	1/4x28	1"	3
85210	5/16x18	1"	3
85220	5/16x24	1"	3
85230	3/8x16	1"	3
85240	3/8x24	1"	3
85250	7/16x14	1"	3
85260	7/16x20	1"	3
85270	1/2x13	1"	3
85280	1/2x20	1"	3
85290	9/16x12	1-1/2"	1
85300	9/16x18	1-1/2"	1
85310	5/8x11	1-1/2"	1
85320	5/8x18	1-1/2"	1
85330	11/16x11	2"	1
85340	11/16x16	1-1/2"	1
85350	3/4x10	2"	1
85360	3/4x16	2"	1
85370	7/8x9	2"	1
85380	7/8x14	2"	1
85390	1x8	2"	1
85400	1x12	2"	1
85410	1x14	2"	1
85420	1/8x27	1"	3
85430	1/4x18	1-1/2"	1
85440	3/8x18	1-1/2"	1
85450	1/2x14	1-1/2"	1

These items are also available carded. See Price List Catalog for details.

TYPE 400 -ROUND MACHINE SCREW & FRACTIONAL

Part No.	Size	O.D.	Qty. per/pack
53600	4x36	1"	3
53610	4x40	1"	3
53620	5x40	1"	3
53630	6x32	1"	3
53640	8x32	1"	3
53650	10x24	1"	3
53660	10x32	1"	3
53670	12x24	1"	3
53680	14x20	1"	3
53690	3/16x24	1"	3
53700	3/16x32	1"	3
53710	1/4x20	1"	3
53720	1/4x28	1"	3
53730	5/16x18	1"	3
53820	5/16x24	1"	3
53740	3/8x16	1"	3
53750	3/8x24	1"	3
53760	7/16x14	1"	3
53830	7/16x20	1"	3
53770	1/2x13	1"	3
53780	1/2x20	1"	3
53790	1/2x24	1"	3
53800	1/8x27 (PIPE)	1"	3
53810	1/4x18 (PIPE)	1"	3

These items are also available carded. See Price List Catalog for details.

ADJUSTABLE & ROUND DIES: TIPS

Adjustable Dies:

These dies have a recessed adjusting screw so threads can be cut slightly under-size or oversize.

Round Dies:

Inexpensive round dies are 1" wide. They will thread rods up to 1/2" diameter.

Hi-Carbon Steel Taps

HI-CARBON TAPS - METRIC PLUG & TAPERED PIPE TAPS

Type 780 -Metric Plug

- All popular sizes offered for foreign car, motorcycle, and machinery threading needs.



TYPE 780 -METRIC PLUG

Part No.	Size	Tap Drill Size	Number of Flutes	Qty. per/pack
83010	3x.50	40	3	3
83020	3x.60	3/32	3	3
83030	4x.70	1/8	4	3
83040	4x.75	1/8	4	3
83050	5x.80	11/64	4	3
83060	5x.90	20	4	3
83070	6x1.00	13/64	4	3
83080	7x1.00	15/64	4	3
84230	8x1.00	F	4	3
83090	8x1.25	17/64	4	3
83100	9x1.00	5/16	4	3
83110	9x1.25	5/16	4	3
56800	10x1.00	23/64	4	3
83130	10x1.25	S	4	3
83140	10x1.50	11/32	4	3
83150	11x1.50	3/8	4	3
84240	12x1.25	27/64	4	3
83160	12x1.50	13/32	4	3
83170	12x1.75	27/64	4	3
56810	14x1.25	33/64	4	1
84250	14x1.50	1/2	4	1
83190	14x2.00	15/32	4	1
83200	16x1.50	37/64	4	1
83210	16x2.00	35/64	4	1
56820	18x1.50	21/32	4	1
84260	18x2.00	5/8	4	1
83230	18x2.50	39/64	4	1

These items are also available carded. See Price List Catalog for details.

Type 410 Pipe Taps

- Made of tough carbon steel to industry standards.

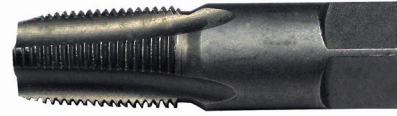

TYPE 410 PIPE TAPS FRACTIONAL

Part No.	Diameter	Tap Drill Size	Shank	Number of Flutes	Qty. per/pack
56910	1/8 x 27	11/32	5/16"	4	3
56920	1/4 x 18	7/16	7/16"	4	3
56930	3/8 x 18	37/64	1/2"	4	1
56940	1/2 x 14	23/32	1/2"	4	1
56950	3/4 x 14	59/64	5/8"	5	1
56960	1 x 11-1/2	1-5/32	13/16"	5	1
56970	1-1/4 x 11-1/2	1-1/2	1"	5	1
56980	1-1/2 x 11-1/2	1-47/64	1-1/4"	7	1
56990	2 x 11-1/2	2-7/32	1-3/8"	7	1



Product Tips

NEED A TAPPING LUBE ?
High Performance Ultra SP™ will do the job!
Found on page 106

METRIC

Hi-Carbon - Metric Plug & Pipe Taps

Hi-Carbon Taps & Dies



14PC / 16PC HI-CARBON TAP & DIE SETS

Type 724

Professional Quality

- Made of high carbon tool steel
- Sharp, clean cutting edges, hardened, and tempered to cut smooth threads
- Sets are available in round and hexagon styles
- Sets are packed in plastic cases
- Select sizes of dies may be imported

14pc. Hi-Carbon Steel Fractional NC - with Hex Die Set

Set contains:

- Hi-Carbon steel plug taps and hex dies sizes:
1/4-20, 5/16-18, 3/8-16, 7/16-14, 1/2-13, 1/8-27 NPT Pipe
- T-Handle Tap Wrench: 3/16 to 1/2
- Stock #HNC14pc

Supplied in sturdy plastic case.

PART NO. 50090

16pc. Hi-Carbon Steel Metric - with Hex Die Set

Set contains:

- Hi-Carbon steel plug taps and hex dies sizes:
4mm x 0.70, 5mm x 0.80, 6mm x 1.00, 8mm x 1.25,
10mm x 1.25, 10mm x 1.50, 12mm x 1.50
- T-Handle Tap Wrench: 3/16 to 1/2
- Stock #HMM16pc

PART NO. 50140

14pc. Hi-Carbon Steel Fractional NF - with Hex Die Set

Set contains:

- Hi-Carbon steel plug taps and hex dies sizes:
1/4-28, 5/16-24, 3/8-24, 7/16-20, 1/2-20, 1/8-27 NPT Pipe
- T-Handle Tap Wrench: 3/16 to 1/2
- Stock #HNF14pc

Supplied in sturdy plastic case.

PART NO. 50080

16pc. Hi-Carbon Steel Fractional NC - with Hex Die Set

Set contains:

- Hi-Carbon steel plug taps and hex dies sizes:
4-40, 6-32, 8-32, 10-24, 10-32, 12-24, 1/4-20
- T-Handle Tap Wrench: 0 to 1/4
- Stock #HEX16pc

PART NO. 50100

14pc. Hi-Carbon Steel Fractional NC - with Round Die Set

Set contains:

- Hi-Carbon steel plug taps and round dies sizes:
1/4-20, 5/16-18, 3/8-16, 7/16-14, 1/2-13, 1/8-27 NPT Pipe
- T-Handle Tap Wrench: 3/16 to 1/2
- Stock #RNC14pc

Supplied in sturdy plastic case.

PART NO. 50030

16 Piece Hi-Carbon Steel Fractional NC - with Round Die Set

Set contains:

- Hi-Carbon steel plug taps and round dies sizes:
4-40, 6-32, 8-32, 10-24, 10-32, 12-24, 1/4-20
- T-Handle Tap Wrench: 0 to 1/4
- Stock #RND19pc

PART NO. 50040

14 Piece Hi-Carbon Steel Fractional NF - with Round Die Set

Set contains:

- Hi-Carbon steel plug taps and round dies sizes:
1/4-28, 5/16-24, 3/8-24, 7/16-20, 1/2-20, 1/8-27 NPT Pipe
- T-Handle Tap Wrench: 3/16 to 1/2

Supplied in sturdy plastic case.

PART NO. 50020

Hi-Carbon Taps & Dies

24PC / 37PC HI-CARBON TAP & DIE SETS

Type 724

Professional Quality

- Made of high carbon tool steel.
- Plug taps are furnished in all sets.
- Dies are available in round and hexagon styles.
- Sets are packed in plastic.
- Select sizes of dies may be imported



24pc. Hi-Carbon Steel Fractional Tap NC, NF - with Hex Die Set

Set contains:

- Hi-Carbon steel plug taps and hex dies sizes:
1/4-20, 1/4-28, 5/16-18, 5/16-24, 3/8-16, 3/8-24,
7/16-14, 7/16-20, 1/2-13, 1/2-20, 1/8-27 NPT Pipe
- T-Handle Tap Wrench: 3/16 to 1/2
- Economy die stock
- Stock #HEX24pc

Supplied in sturdy plastic case.

PART NO. 50110

24pc. Hi-Carbon Steel Fractional Tap NC, NF - with Round Die Set

Set contains:

- Hi-Carbon steel plug taps and round dies sizes:
1/4-20, 1/4-28, 5/16-18, 5/16-24, 3/8-16, 3/8-24,
7/16-14, 7/16-20, 1/2-13, 1/2-20, 1/8-27 NPT Pipe
- T-Handle Tap Wrench: 3/16 to 1/2
- Economy die stock
- Stock #RND24pc

Supplied in sturdy plastic case.

PART NO. 50050

37pc. Hi-Carbon Steel Machine Screw & Fractional Tap NC, NF - with Round Die Set

Set contains:

- Hi-Carbon steel plug taps and round dies sizes:
4-40, 6-32, 8-32, 10-24, 10-32, 12-24, 1/4-20, 1/4-28,
5/16-18, 5/16-24, 3/8-16, 3/8-24, 7/16-14, 7/16-20,
1/2-13, 1/2-20, 1/8-27 NPT Pipe
- T-Handle Tap Wrench: 0 to 1/4 & 3/16 to 1/2
- Economy die stock
- Stock #RND37pc

Supplied in sturdy plastic case.

PART NO. 50060

37pc. Hi-Carbon Steel Master Metric - with Hex Die Set

Set contains:

- Hi-Carbon steel plug taps and hex dies sizes:
3mm x 0.50, 3mm x 0.60, 4mm x 0.70, 4mm x 0.75,
5mm x 0.80, 5mm x 0.90, 6mm x 1.00, 7mm x 1.00,
8mm x 1.25, 9mm x 1.00, 9mm x 1.25, 10mm x 1.25,
10mm x 1.50, 11mm x 1.50, 12mm x 1.50, 12mm x 1.75,
1/8-27 NPT Pipe
- T-Handle Tap Wrench: 0 to 1/4 & 3/16 to 1/2
- Stock #HMM37pc

Supplied in sturdy plastic case.

PART NO. 50150

37pc. Hi-Carbon Steel Machine Screw & Fractional NC, NF - with Hex Die Set

Set contains:

- Hi-Carbon steel plug taps and hex dies sizes:
4-40, 6-32, 8-32, 10-24, 10-32, 12-24, 1/4-20, 1/4-28,
5/16-18, 5/16-24, 3/8-16, 3/8-24, 7/16-14, 7/16-20,
1/2-13, 1/2-20, 1/8-27 NPT Pipe
- T-Handle Tap Wrench: 0 to 1/4 & 3/16 to 1/2
- Stock #HEX37pc

Supplied in sturdy plastic case.

PART NO. 50120

40pc HI-CARBON MACHINE SCREW / FRACTIONAL

Type 724

Professional Quality

- Taps and Dies made of high carbon steel.
- Plug taps are furnished in all sets in sizes to fill most requirements.
- Dies are available in round and hex styles.
- Sets are packed in durable plastic cases.
- Select sizes of dies may be imported.



40pc. Hi-Carbon Steel Machine Screw Fractional Tap NC, NF - with Round Die Set

Set contains:

- Hi-Carbon steel plug taps and round dies sizes: 4-40 , 6-32, 8-32, 10-24, 10-32, 12-24, 1/4-20, 1/4-28, 5/16-18, 5/16-24, 3/8-16, 3/8-24, 7/16-14, 7/16-20, 1/2-13, 1/2-20, 1/8-27 NPT Pipe
- T-Handle Tap Wrench: 0 to 1/4 & 3/16 to 1/2
- Tap & Reamer Wrench: #4 to 1/2
- Adjustable Die Stock, Screw Driver, Screw Pitch Gauge
- Stock #RND40pc

Supplied in sturdy plastic case.

PART NO. 50070

40pc. Hi-Carbon Steel Machine Screw/Fractional NC, NF - with Hex Die Set

Set contains:

- Hi-Carbon steel plug taps and hex dies sizes: 4-40 , 6-32, 8-32, 10-24, 10-32, 12-24, 1/4-20, 1/4-28, 5/16-18, 5/16-24, 3/8-16, 3/8-24, 7/16-14, 7/16-20, 1/2-13, 1/2-20, 1/8-27 NPT Pipe
- T-Handle Tap Wrench: 0 to 1/4 & 1/4 to 1/2
- Tap & Reamer Wrench: 0 to 1/2
- Adjustable Die Stock, Screw Driver, Screw Pitch Gauge
- Stock #HEX40pc

Supplied in sturdy plastic case.

PART NO. 50130

Tap & Reamer Wrenches

TAP & REAMER WRENCHES

- Accessories for every threading job, economy, and professional type.
 - Rugged construction.
- Tap wrench jaws heat treated and hardened for long life.
 - Offered in display packages as indicated.



Type 725
Tap & Reamer Wrench
- Professional Quality

- Hardened steel jaws. Adjusts easily by turning handles

Part No.	For Tap Sizes	Package Type	Qty. per/pack
50350	1/4" - 3/4"	Bulk	1
50360	1/2" - 1-1/8"	Bulk	1
50347	1/4" - 1/2"	Carded	1

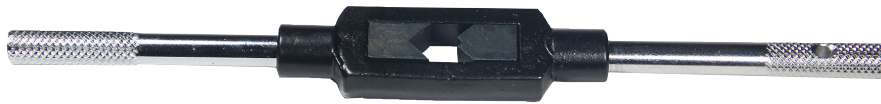

Type 726
Tap & Reamer Wrench
Economy -

- For taps up to 1/2"
- Chrome finished, Knurled handles with black center.

Part No.	For Tap Sizes	Package Type	Qty. per/pack
50337	Up to 1/2"	Carded	1

Type 727R
Ratcheting T-Handle Tap Wrenches

- Three position gear box for quick efficient ratcheting action
- Designed for use with taps, reamers, screw extractors and other tools with a square shank.
- Chrome plated for long life and rust resistance



Part No.	For Tap Sizes	Package Type	Qty. per/pack
50190	0 - 1/4" (3mm - 6mm)	Bulk	1
50200	1/4 - 1/2" (6mm - 12mm)	Bulk	1



Type 727
T-Handle Tap Wrenches

- Sliding T-handle with spring tension to hold taps in place, self equalizing jaws.
 - No. 50320 has removable handle and 3/8" female square drive for extensions, ratchet, and power drive.

Part No.	For Tap Sizes	Package Type	Qty. per/pack
50307	0" - 1/4"	Carded	1
50310	3/16" - 1/2"	Bulk	1
50320	3/16" - 1/2"	Bulk	1

Die Stocks & Gauges

DIE STOCKS AND SCREW PITCH GAUGES

- Accessories for every threading job, economy and professional type.
- Rugged construction. Offered in display packages as indicated.



Type 728R
- Round Die Stock

- Designed to hold either 1"- Round

TYPE 728R DIE STOCK

Part No.	Across Flats	Package Type	Qty. per/pack
53897	1/4" - 1/2"	Carded	1

Type 728
Die Stock
- Hex/RND Die Stock

- Designed to hold either 1"- Round or Hex Dies



TYPE 728 DIE STOCK

Part No.	Across Flats	Package Type	Qty. per/pack
50380	1" Round or Hex	Carded	1



Type 729
Die Stock
- Professional Quality

- Numbers 50387 and 50390 have 3-jaw self centering adjustable guides to assure straight threads and easy starting.

- Number 50400 is a sturdy cast hex die stock with chromed steel handles.

TYPE 729 DIE STOCK

Part No.	Across Flats	Package Type	Qty. per/pack
50390	1-1/2" Round, 1-7/16 Hex	Bulk	1
50400	1-7/8" Hex	Bulk	1
50387	1" Round or Hex	Carded	1

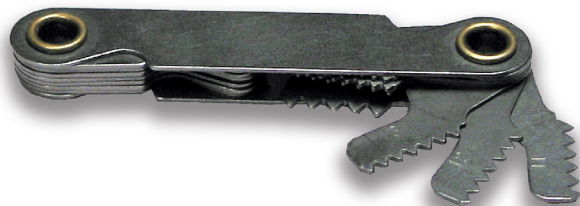

Type 730
- Screw Pitch Gauges

- Made with flat thread forms on top of each blade.
- Gives screw pitches on V-threads, U.S. and Metric gauge available.

TYPE 730 SCREW PITCH GAUGES

Part No.	For Tap Sizes	Package Type	Qty. per/pack
50417	US 12 - 40 U.S.	Carded	1
50427	METRIC 0.5 - 1.75 mm, #27 and #28	Carded	1

Technical Reference

STANDARD CUTTING TAPS

Machine Screw Sizes

Tap	Tap Drill	Decimal Equiv. of Tap Drill	Theoretical % of Thread	Probable Oversize (Mean)	Probable Hole Size	Percentage of Thread
0-80	56	.0465	83	.0015	.0480	74
	$\frac{3}{64}$.0469	81	.0015	.0484	71
1-64	54	.0550	89	.0015	.0565	81
1-72	53	.0595	75	.0015	.0610	67
2-56	51	.0670	82	.0017	.0687	74
	50	.0700	69	.0017	.0717	62
2-64	50	.0700	79	.0017	.0717	70
3-48	48	.0760	85	.0019	.0779	78
	$\frac{3}{64}$.0781	77	.0019	.0800	70
	47	.0785	76	.0019	.0804	69
	46	.0810	67	.0019	.0829	60
3-56	46	.0810	78	.0019	.0829	69
	45	.0820	73	.0019	.0839	65
4-40	44	.0860	80	.0020	.0880	74
	43	.0890	71	.0020	.0910	65
4-48	42	.0935	68	.0020	.0955	61
	$\frac{3}{32}$.0938	68	.0020	.0958	60
5-40	40	.0980	83	.0023	.1003	76
	39	.0995	79	.0023	.1018	71
	38	.1015	72	.0023	.1038	65
5-44	38	.1015	79	.0023	.1038	72
	37	.1040	71	.0023	.1063	63
6-32	37	.1040	84	.0023	.1063	78
	36	.1065	78	.0026	.1091	71
	$\frac{3}{64}$.1094	70	.0026	.1120	64
	35	.1100	69	.0026	.1126	63
	34	.1110	67	.0026	.1136	60
6-40	34	.1110	83	.0026	.1136	75
	33	.1130	77	.0026	.1156	69
	32	.1160	68	.0026	.1186	60
8-32	29	.1360	69	.0029	.1389	62
8-36	29	.1360	78	.0029	.1389	70
10-24	27	.1440	85	.0032	.1472	79
	26	.1470	79	.0032	.1502	74
	25	.1495	75	.0032	.1527	69
	24	.1520	70	.0032	.1552	64
	23	.1540	67	.0032	.1572	61
10-32	$\frac{3}{32}$.1563	83	.0032	.1595	75
	22	.1570	81	.0032	.1602	73
	21	.1590	76	.0032	.1622	68
	20	.1610	71	.0032	.1642	64
12-24	$\frac{1}{16}$.1719	82	.0035	.1754	75
	17	.1730	79	.0035	.1765	73
	16	.1770	72	.0035	.1805	66
	15	.1800	67	.0035	.1835	60
12-28	16	.1770	84	.0035	.1805	77
	15	.1800	78	.0035	.1835	70
	14	.1820	73	.0035	.1855	66

These tables show both the theoretical percentage of thread represented by the drill size and the percentage that would normally be obtained in drilling.

Fractional Sizes

Tap	Tap Drill	Decimal Equiv. of Tap Drill	Theoretical % of Thread	Probable Oversize (Mean)	Probable Hole Size	Percentage of Thread
$\frac{1}{4}$ -20	9	.1960	83	.0038	.1998	77
	8	.1990	79	.0038	.2028	73
	7	.2010	75	.0038	.2048	70
	$\frac{13}{64}$.2031	72	.0038	.2069	66
	6	.2040	71	.0038	.2078	65
	5	.2055	69	.0038	.2093	63
	4	.2090	63	.0038	.2128	57
$\frac{1}{4}$ -28	3	.2130	80	.0038	.2168	72
	F	.2570	77	.0038	.2608	72
	G	.2610	71	.0041	.2651	66
$\frac{5}{16}$ -24	H	.2660	86	.0041	.2701	78
	I	.2720	75	.0041	.2761	67
$\frac{3}{8}$ -16	$\frac{5}{16}$.3125	77	.0044	.3169	72
	O	.3160	73	.0044	.3204	68
$\frac{3}{8}$ -24	$\frac{21}{64}$.3281	87	.0044	.3325	79
	Q	.3320	79	.0044	.3364	71
$\frac{7}{16}$ -14	T	.3580	86	.0046	.3626	81
	$\frac{23}{64}$.3594	84	.0046	.3640	79
	U	.3680	75	.0046	.3726	70
	$\frac{3}{8}$.3750	67	.0046	.3796	62
	V	.3770	65	.0046	.3816	60
$\frac{7}{16}$ -20	W	.3860	79	.0046	.3906	72
	$\frac{25}{64}$.3906	72	.0046	.3952	65
$\frac{1}{2}$ -13	$\frac{27}{64}$.4219	78	.0047	.4266	73
	$\frac{29}{64}$.4531	72	.0047	.4578	65
$\frac{1}{2}$ -20	$\frac{15}{32}$.4688	87	.0048	.4736	82
	$\frac{31}{64}$.4844	72	.0048	.4892	68
$\frac{9}{16}$ -18	$\frac{1}{2}$.5000	87	.0048	.5048	80
$\frac{5}{8}$ -11	$\frac{17}{32}$.5313	79	.0049	.5362	75
	$\frac{35}{64}$.5469	66	.0049	.5518	62
$\frac{5}{8}$ -18	$\frac{9}{16}$.5625	87	.0049	.5674	80
$\frac{3}{4}$ -10	$\frac{41}{64}$.6406	84	.0050	.6456	80
	$\frac{21}{32}$.6563	72	.0050	.6613	68
$\frac{3}{4}$ -16	$\frac{11}{16}$.6875	77	.0050	.6925	71
$\frac{7}{8}$ -9	$\frac{49}{64}$.7656	76	.0052	.7708	72
	$\frac{25}{32}$.7812	65	.0052	.7864	61
$\frac{7}{8}$ -14	$\frac{81}{64}$.7969	84	.0052	.8021	79
	$\frac{13}{16}$.8125	67	.0052	.8177	62
1"- 8	$\frac{89}{64}$.8594	87	.0059	.8653	83
	$\frac{7}{8}$.8750	77	.0059	.8809	73
	$\frac{85}{64}$.8906	67	.0059	.8965	64
1"-12	$\frac{23}{32}$.9063	87	.0060	.9122	81
	$\frac{89}{64}$.9219	72	.0060	.9279	67
1"-14	$\frac{89}{64}$.9219	84	.0060	.9279	78
	$\frac{15}{16}$.9375	67	.0060	.9435	61
	$\frac{31}{32}$.9688	84	.0062	.9750	81
1 $\frac{1}{8}$ - 7	$\frac{83}{64}$.9844	76	.0067	.9911	72
	1"	1.0000	67	.0070	1.0070	64
	$\frac{13}{32}$	1.0313	87	.0071	1.0384	80
1 $\frac{1}{8}$ -12	1 $\frac{3}{64}$	1.0469	72	.0072	1.0541	66
	1 $\frac{3}{32}$	1.0938	84			
1 $\frac{1}{4}$ - 7	1 $\frac{7}{64}$	1.1094	76			
	1 $\frac{1}{8}$	1.1250	67			
	1 $\frac{5}{32}$	1.1563	87			
1 $\frac{1}{4}$ -12	1 $\frac{11}{64}$	1.1719	72			
	1 $\frac{3}{16}$	1.1875	87			
1 $\frac{3}{8}$ - 6	1 $\frac{13}{64}$	1.2031	79			
	1 $\frac{7}{32}$	1.2188	72			
	1 $\frac{15}{64}$	1.2344	65			
1 $\frac{3}{8}$ -12	1 $\frac{9}{32}$	1.2813	87			
	1 $\frac{19}{64}$	1.2969	72			
1 $\frac{1}{2}$ - 6	1 $\frac{5}{16}$	1.3125	87			
	1 $\frac{21}{64}$	1.3281	79			
	1 $\frac{11}{32}$	1.3438	72			
	1 $\frac{23}{64}$	1.3594	65			
1 $\frac{1}{2}$ -12	1 $\frac{13}{32}$	1.4063	87			
	1 $\frac{27}{64}$	1.4219	72			

Reaming Recommended

Metric Cutting Taps

Metric Tap Size	Basic Major Dia. (Ins.)	Tap Drill Size	Decimal Equiv. of Tap Drill (Ins.)	Theoretical Percent of Thread	Probable Mean Over-Size (Ins.)	Probable Hole Size (Ins.)	Probable Percent of Thread
M1.6 x 0.35	.0630	1.25 mm	.0492	77	.0015	.0507	69
M1.8 x 0.35	.0709	1.45 mm	.0571	77	.0015	.0586	69
M2 x 0.4	.0787	1/16"	.0625	79	.0015	.0640	72
		1.60 mm	.0630	77	.0017	.0647	69
		#52	.0635	74	.0017	.0652	66
M2.2 x 0.45	.0866	1.75 mm	.0689	77	.0017	.0706	70
M2.5 x 0.45	.0984	2.05 mm	.0807	77	.0019	.0826	69
		#46	.0810	76	.0019	.0829	67
		#45	.0820	71	.0019	.0839	63
M3 x 0.5	.1181	#40	.0980	79	.0023	.1003	70
		2.5 mm	.0984	77	.0023	.1007	68
		#39	.0995	73	.0023	.1018	64
M3.5 x 0.6	.1378	#33	.1130	81	.0026	.1156	72
		2.9 mm	.1142	77	.0026	.1168	68
		#32	.1160	71	.0026	.1186	63
M4 x 0.7	.1575	*3.25 mm	.1280	82	.0029	.1309	74
		#30	.1285	81	.0029	.1314	73
		3.3 mm	.1299	77	.0029	.1328	69
M4.5 x 0.75	.1772	3.7 mm	.1457	82	.0032	.1489	74
		#26	.1470	79	.0032	.1502	70
		*3.75 mm	.1476	77	.0032	.1508	69
		#25	.1495	72	.0032	.1527	64
M5 x 0.8	.1968	4.2 mm	.1654	77	.0032	.1686	69
		#19	.1660	75	.0032	.1692	68
M6 x 1	.2362	#10	.1935	84	.0038	.1973	76
		#9	.1960	79	.0038	.1998	71
		5 mm	.1968	77	.0038	.2006	70
		#8	.1990	73	.0038	.2028	65
M7 x 1	.2756	"A"	.2340	81	.0038	.2378	74
		1 5/64"	.2344	81	.0038	.2382	73
		6 mm	.2362	77	.0038	.2400	70
		"B"	.2380	74	.0038	.2418	66
M8 x 1.25	.3150	6.7 mm	.2638	80	.0041	.2679	74
		1 5/64"	.2656	77	.0041	.2697	71
		*6.75 mm	.2657	77	.0041	.2698	71
		"H"	.2660	77	.0041	.2701	70
M8 x 1	.3150	6.8 mm	.2677	74	.0041	.2718	68
		7 mm	.2756	77	.0041	.2797	69
M10 x 1.5	.3937	"J"	.2770	74	.0041	.2811	66
		8.4 mm	.3307	82	.0044	.3351	76
		"Q"	.3320	80	.0044	.3364	75
M10 x 1.25	.3937	8.5 mm	.3346	77	.0044	.3390	71
		8.7 mm	.3425	80	.0046	.3471	73
		1 1/32"	.3438	78	.0046	.3483	71
M12 x 1.75	.4724	*8.75 mm	.3445	77	.0046	.3491	70
		10.2 mm	.4016	79	.0047	.4063	74
		"Y"	.4040	76	.0047	.4087	71
		1 3/32"	.4062	74	.0047	.4109	69

Metric Tap Size	Basic Major Dia. (Ins.)	Tap Drill Size	Decimal Equiv. of Tap Drill (Ins.)	Theoretical Percent of Thread	Probable Mean Over-Size (Ins.)	Probable Hole Size (Ins.)	Probable Percent of Thread
M12 x 1.25	.4724	2 7/64"	.4219	79	.0047	.4266	72
		10.8 mm	.4252	74	.0047	.4299	66
M14 x 2	.5512	1 1/32"	.4688	81	.0048	.4736	76
		12 mm	.4724	77	.0048	.4772	72
M14 x 1.5	.5512	12.5 mm	.4921	77	.0048	.4969	71
M16 x 2	.6299	3 9/64"	.5469	81	.0049	.5518	76
		14 mm	.5512	77	.0049	.5561	72
M16 x 1.5	.6299	14.5 mm	.5709	77	.0049	.5758	71
M18 x 2.5	.7087	3 9/64"	.6094	78	.0050	.6144	74
		15.5 mm	.6102	77	.0050	.6152	73
M18 x 1.5	.7087	4 1/64"	.6406	89	.0050	.6456	82
		16.5 mm	.6496	77	.0050	.6546	70
M20 x 2.5	.7874	2 1/32"	.6562	68	.0050	.6612	62
		1 1/16"	.6875	78	.0050	.6925	74
M20 x 1.5	.7874	17.5 mm	.6890	77	.0052	.6942	73
		18.5 mm	.7283	77	.0052	.7335	70
M22 x 2.5	.8661	4 9/64"	.7656	79	.0052	.7708	75
		19.5 mm	.7677	77	.0052	.7729	73
M22 x 1.5	.8661	20.5 mm	.8071	77	.0052	.8123	70
M24 x 3	.9449	21 mm	.8268	77	.0059	.8327	73
		5 3/64"	.8281	76	.0059	.8340	72
M24 x 2	.9449	22 mm	.8661	77	.0059	.8720	71
M27 x 3	1.0630	1 5/16"	.9375	82	.0060	.9435	78
		24 mm	.9449	77	.0062	.9511	73
M27 x 2	1.0630	25 mm	.9843	77	.0070	.9913	70
		5 3/64"	.9844	77	.0070	.9914	70
M30 x 3.5	1.1811	26.5 mm	1.0433	77			
		1 3/64"	1.0469	75			
M30 x 2	1.1811	28 mm	1.1024	77			
		1 1/64"	1.1094	70			
M33 x 3.5	1.2992	1 1/32"	1.1562	80			
		29.5 mm	1.1614	77			
M33 x 2	1.2992	1 1/64"	1.1719	71			
		31 mm	1.2188	79			
M36 x 4	1.4173	1 1/4"	1.2500	82			
		32 mm	1.2598	77			
M36 x 3	1.4173	1 9/64"	1.2969	78			
		33 mm	1.2992	77			
M39 x 4	1.5354	1 3/8"	1.3750	78			
		35 mm	1.3780	77			
M39 x 3	1.5354	36 mm	1.4173	77			
		1 7/64"	1.4219	74			

REAMING RECOMMENDED

Note: Sizes with an asterisk (*) are not standard drills.

METRIC THREAD FORMULAE

$$\text{Basic major dia. (mm)} - \frac{\% \text{ thread} \times \text{mm pitch}}{76.980} = \text{Drilled hole size (mm)}$$

$$\frac{76.980}{\text{mm pitch}} \times [\text{Basic major dia. (mm)} - \text{Drilled hole size (mm)}] = \% \text{ of thread}$$

Taps

Problems encountered in tapping are often the fault of the tapping machine, tap holding devices and conditions of the hole to be tapped. The tapping machine should be checked for spindle, fixture and work alignment; for slipping belts, wear and power. The tap holding device should be checked as to correct type, for wear and alignment with the hole. The drilled hole should be checked for diameter and trueness in round and axis to assure correct percentage of thread engagement. Blind holes must have sufficient chip room at the bottom.

General Suggestions

1. If holes are undersize or oversize check against the setup instructions. Check the tap for correct pitch diameter limit for desired class of thread, and the drill for correct size.
2. If the tap is producing rough thread it generally means that the tap is pushing or tearing the metal instead of cutting it. The tap may be dull, have galled threads or may be running at too slow a speed. If none of these, increase the hook angle of the cutting face.
3. If the tap is loading (metal clinging to the tap) or galling, check the lubrication. Here, too, the tap may be dull, or it may be producing too high a percentage of thread. Shift to a surface-treated tap.
4. If tap breakage is encountered the tap may be cutting too high a percentage of thread, be insufficiently lubricated or have too little clearance for chips at the bottom of the blind hole. If none of these conditions exist, increase the speed, except in hard or tough materials. In these materials, lower the speed.

Trouble	Cause
Tap Breakage	<ol style="list-style-type: none"> 1. Wrong type of tap. 2. Dull tap. 3. Tap incorrectly ground. 4. Tap drill too small. 5. Drilled hole too shallow. 6. Misalignment of tap and hole. 7. Wrong machine. 8. Incorrect fixture or holding device. 9. Work hardened material/ 10. Lack of lubricant, or use of wrong type.
Tap Failure on Reversal	<ol style="list-style-type: none"> 1. Tap cutting too tightly. Cutting face angle should be increased. 2. Tap galling. Face angle on back of land should be increased. 3. Chips wedged between flutes. (See the following)
Chips Clogging Flutes	<ol style="list-style-type: none"> 1. Wrong type of tap. 2. Insufficient chamfer. 3. Incorrect cutting face angle. 4. Rough Flutes. 5. Flutes improperly reground. 6. Lack of lubrication, or use of wrong type.
Stripped or Chipped Tap Threads	<ol style="list-style-type: none"> 1. Misalignment. 2. Careless handling. 3. Dull Tap 4. Tap too hard. 5. Wrong application of surface treated taps. 6. Improper sharpening of tap.
Torn Threads in Tapped Part	<ol style="list-style-type: none"> 1. Incorrect cutting face angle (usually too small). 2. Tap drill too small. 3. Chips clogging flutes. 4. Broken threads on taps. 5. Improper resharpening of tap. 6. Lack of lubricant, or use of wrong type.
Tap Sticking or Binding	<ol style="list-style-type: none"> 1. Tap drill too small. 2. Tap lands too wide. 3. Incorrect cutting face angle. 4. Lack of lubricant, or use of wrong type. 5. Surface treatment (lubricant) required.
Excessive Tap Wear	<ol style="list-style-type: none"> 1. Material is abrasive, or inclusions present. Surface treated tap required. 2. Misalignment.
Cutting Face Breakdown	<ol style="list-style-type: none"> 1. Incorrect cutting face angle. 2. Surface treatment required.
Overheating of Tap	<ol style="list-style-type: none"> 1. Excessive land width. 2. Lack of lubricant, or use of wrong type. 3. Dull tap. 4. Excessive flank contact, pitch diameter relief required. 5. Excessive tapping speeds.
Poor Finish on Thread in Tapped Part	<ol style="list-style-type: none"> 1. Pitch diameter relief required. 2. Incorrect cutting face angle, usually too small. 3. Tap drill too small. 4. Insufficient number of chamfered threads. 5. Dull tap. 6. Lack of lubricant, or use of wrong type.
Excessive Frictional Drag and Power Requirement	<ol style="list-style-type: none"> 1. Pitch diameter relief required. 2. Point size on tap too small. 3. Dull tap. 4. Incorrect cutting face angle. 5. Incorrect tapping speed. 6. Lack of lubricant, or use of wrong type. 7. Incorrect or inadequate equipment. 8. Misalignment.

Tap Limits, Product Limits

CLASS OF THREAD

We sometimes receive requests for a Class 3B (or other class) tap. Many times the customer will ask for a tap to produce a "Class 3B Fit". Ordering taps by these specifications is incorrect and often impractical. The following information is presented to clarify the difference between the terms Class of Thread, Tap Limits and Product Limits to make ordering taps easier and aid the customer in obtaining the tap best suited for their requirements.

Class of Thread

Class of Thread refers simply to the tolerances that control the closeness of fit between two threaded mating parts. This term should be used only in reference to a threaded assembly, as, for example, a screw and nut.

Product Limits

Product Limits refer to the limits and tolerances of the internal or female thread. The degree of tolerance is expressed by the terms Class 2, 2B, 3 and 3B. Product limits refer to the various limits and tolerances applying to nuts or internal threads and are identified by the terms Class 2, 2B, 3 or 3B.

Tap Limits

Tap Limits refer to the various sizes of taps manufactured to permit selection of a tap which will produce an internal thread within the desired product limit. Tap limits are designated as L-1, H-1, H-2, H-3, etc.

In the chart on this page we have illustrated the difference between tap and product limit, using a 1/4-20 tapped hole as the example.

Although ground thread taps are produced to precision tolerances under closely controlled manufacturing processes and are guaranteed for accuracy of individual elements, there is always the possibility of the presence of unknown factors which can be detrimental to good tap performance. The tap manufacturer, therefore, is not able to guarantee the size of the tapped hole.

To summarize, the following points should be remembered :

1. A tap cannot produce a Class of Thread. It can produce a tapped hole within specific product limits.
2. Since it is used only in tapping a hole, or producing an internal thread, a tap has no control over the fitting properties of the mating external thread.
3. To produce what is commonly referred to as a "Class of Thread," both the external and internal threads must be within their respective product limits. Only when both members of a threaded assembly fall within the desired class limits can the proper fit be assured.
4. The acceptability of any class of threaded hole is determined only by an accurate "Go" or "Hi" thread plug gage of the corresponding class. Similarly, the acceptability of a male part with an external thread is also determined by a corresponding "Go" or "Lo" thread ring gage.
5. When ordering taps, specify either the tap limit or the class of thread that identifies the limit of the tapped hole.
6. In special applications, supply as much information as possible. The more information our engineers have to work with, the better they can recommend a tap to do the job properly with least expense.
7. Remember, it is not always the most expensive tap which will do the job best. Our files contain many examples of special jobs which were solved with inexpensive standard taps.

1/4 - 20 Tapped Hole

Class 2 Limit GH-3 Tap

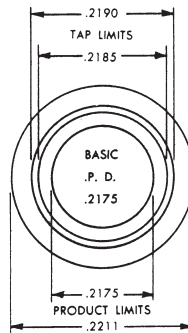

Class 2B Limit GH-5 Tap

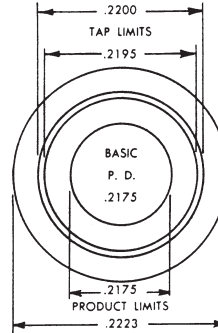

Class 3 Limit GH-2 Tap

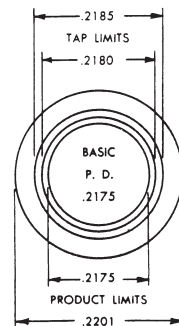

Class 3B Limit GH-3 Tap

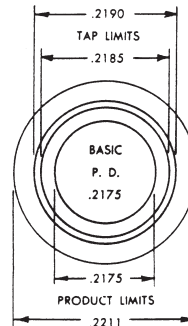

Thread Constants for Various Percentages

TAPS

EXAMPLE: To find the hole size for obtaining 75% of thread in a ¼-20 tapped hole, follow first column to 20 threads, then across to 75% of thread. This figure (.0485) when subtracted from the .250 diameter leaves .2015, which is the required diameter of the hole for a ¼-20 thread.

Relation of Tap Pitch Diameter to Basic Pitch Diameter

Relation of Tap Pitch Diameter To Basic Pitch Diameter

American tap manufacturers use a series of tap pitch diameter limits. These limits feature a .0005" tolerance in tap sizes #0 through 1", and a .001" or greater tolerance in tap sizes above 1" through 1½" diameter, inclusive. The chart shows the relationship between tap pitch diameter limits and basic (nominal) pitch diameter.

FORMULA FOR OBTAINING TAP DRILL SIZES

(Select nearest commercial stock drill)

$$\left(\text{Outside Diam. of Thread} \right) - \left(\frac{.01299 \times \text{Amount of percentage of full thread}}{\text{Number of threads per inch}} \right) = \text{Drilled Hole Size}$$

$$\left(\frac{\text{No. of Threads per inch}}{\text{No. of Threads per inch}} \right) \times \left(\frac{\text{Outside Diam. of thread} - \text{Selected Drill Diam.}}{.01299} \right) = \text{Percentage of Full Thread}$$

Figures in table show amount to subtract from O.D. of screw to obtain specific percentages of thread.

Threads per Inch	Double Depth	60% Thread	65% Thread	70% Thread	75% Thread	80% Thread	85% Thread
6	.21651	.1300	.1408	.1517	.1625	.1733	.1842
7	.18558	.1114	.1207	.1300	.1393	.1486	.1579
8	.16238	.0975	.1056	.1138	.1219	.1300	.1381
9	.14434	.0866	.0939	.1011	.1083	.1156	.1228
10	.12990	.0779	.0844	.0909	.0974	.1039	.1105
11	.11809	.0708	.0767	.0826	.0885	.0944	.1005
12	.10825	.0649	.0702	.0755	.0808	.0861	.0921
13	.09992	.0599	.0649	.0699	.0749	.0799	.0850
14	.09278	.0556	.0602	.0648	.0694	.0740	.0789
16	.08119	.0486	.0526	.0566	.0606	.0646	.0691
18	.07217	.0431	.0466	.0501	.0536	.0571	.0614
20	.06495	.0389	.0421	.0453	.0485	.0517	.0553
24	.05412	.0326	.0354	.0382	.0410	.0438	.0460
27	.04811	.0288	.0312	.0336	.0360	.0384	.0409
28	.04639	.0276	.0298	.0324	.0347	.0370	.0395
30	.04330	.0260	.0282	.0304	.0326	.0348	.0368
32	.04059	.0243	.0263	.0283	.0303	.0323	.0345
36	.03608	.0216	.0234	.0252	.0270	.0288	.0307
40	.03247	.0194	.0210	.0226	.0242	.0258	.0276
44	.02952	.0177	.0192	.0207	.0222	.0237	.0251
48	.02706	.0161	.0174	.0187	.0200	.0213	.0230
56	.02319	.0138	.0149	.0160	.0171	.0182	.0197
64	.02029	.0121	.0131	.0141	.0151	.0161	.0173
72	.01804	.0107	.0115	.0123	.0131	.0139	.0153
80	.01623	.0097	.0105	.0113	.0121	.0129	.0138

EXAMPLE: ¼ — 20NC

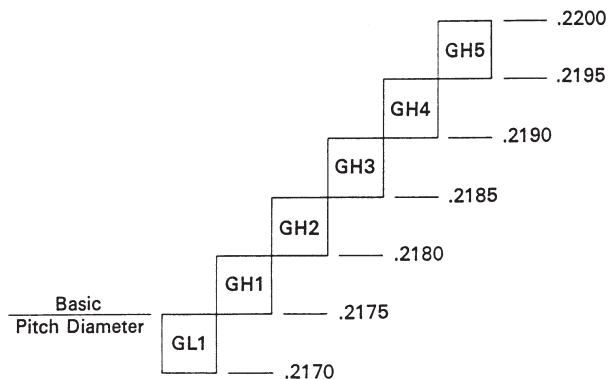

Premium Carbide Burrs

SA Style

Cylinder Shape - No End Cut 87

SB Style

Cylinder Shape - with End Cut 87

SC Style

Cylinder Shape - Radius End 88

SD Style

Ball Shape 88

SE Style

Oval / Egg Shape 89

SF Style

Tree Shape Radius 89

SG Style

Pointed Tree Shape 90

SH Style

Flame Shape 90

SJ Style

60° Cone Shape 90

SK Style

90° Cone Shape 90

SL Style

Taper Shape Radius -
14° Included Angle 90

SM Style

Pointed Cone Shape 91

SN Style

Inverted Cone Shape 91

Premium Carbide Burrs Sets

Double Cut Sets

Set A - 9 pcs 91

Set B - 9 pcs 91

Set C - 9 pcs 91

Set D - 9 pcs 91

Set E - 8 pcs 91

Set F - 8 pcs 91

Double Cut Display

48 pcs.

Double Cut- 1/8 Shank 91

Double Cut- 1/4 Shank 91

Aluma Cut- 1/4 Shank 91

24 pcs.

Double Cut- 1/4 Shank 91

Double Cut

The most popular burr for ferrous applications.

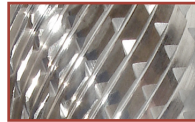

The flutes are ground in both the left and right hand directions, offering better operator control and rapid stock removal in harder materials.

The double cut geometry reduces the size of the chips and can be used at slower than normal speeds.

Aluma Cut

Designed for used on aluminum, non-ferrous metals, soft steel, reinforced plastics and other soft materials.

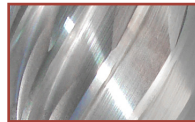

The burrs are designed with a high flute finish for easy chip flow and fast stock removal and excellent work piece finish.

MATERIALS	Aluma Cut	Double Cut
Aluminum	✓	
Brass		✓
Bronze		✓
Copper		✓
Cast Iron		✓
Plastics	✓	
Steel (40-50 RC)		✓
Steel (55-60 RC)		✓
Steel (Carbon)		✓
Steel (Nickel Chrome)		✓
Stainless Steel		✓
Steel Weldments		✓
Titanium		✓
Zinc	✓	

Recommended RPM

Diameter	Standard Materials	Stainless Steel	Diameter	Standard Materials	Stainless Steel
1/16	72500	97500	5/16	28000	28000
3/32	65500	89000	3/8	25000	25000
1/8	56000	76000	7/16	22000	22000
5/32	46000	70000	1/2	18800	18800
3/16	40000	65500	5/8	17000	17000
1/4	35000	61000	3/4	14900	14900
			1"	12600	12600

Premium Carbide Burrs

SA CYLINDER SHAPE - NO END CUT

Application: Deburring

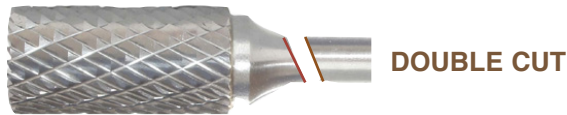
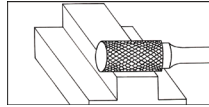

SB CYLINDER SHAPE - WITH END CUT

Application: Peripheral Milling & Face Milling

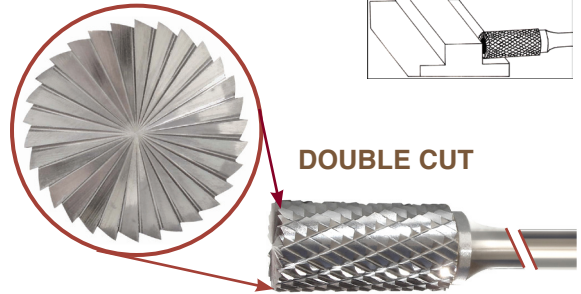
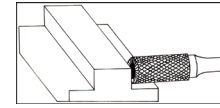

SA - CYLINDER SHAPE - NO END CUT - DOUBLE CUT

Part #	Size	Cut Diameter	Length of Cut	Shank Diameter	Qty.
17079	SA-41	1/16	1/4	1/8	1
17089	SA-42	3/32	7/16	1/8	1
17099	SA-43	1/8	9/16	1/8	1
17109	SA-11	1/8	1/2	1/4	1
17119	SA-12	1/8	5/8	1/4	1
17129	SA-52	5/32	1/2	1/8	1
17139	SA-13	5/32	5/8	1/4	1
17149	SA-14	3/16	5/8	1/4	1
17159	SA-51	1/4	1/2	1/8	1
17169	SA-1	1/4	5/8	1/4	1
17179	SA-1L	1/4	1	1/4	1
17209	SA-2	5/16	3/4	1/4	1
17219	SA-3	3/8	3/4	1/4	1
17229	SA-3L	3/8	1	1/4	1
17249	SA-3X	3/8	1-1/2	1/4	1
17269	SA-4	7/16	1	1/4	1
17279	SA-5	1/2	1	1/4	1
17309	SA-6	5/8	1	1/4	1
17329	SA-15	3/4	1/2	1/4	1
17339	SA-16	3/4	3/4	1/4	1
17349	SA-7	3/4	1	1/4	1
17369	SA-8	7/8	1	1/4	1
17379	SA-9	1	1	1/4	1

SA - CYLINDER SHAPE - NO END CUT - ALUMA

Part #	Size	Cut Diameter	Length of Cut	Shank Diameter	Qty.
17199	SA-1NF	1/4	5/8	1/4	1
17259	SA-3NF	3/8	3/4	1/4	1
17299	SA-5NF	1/2	1	1/4	1
17319	SA-6NF	5/8	1	1/4	1
17359	SA-7NF	3/4	1	1/4	1

SA - CYLINDER SHAPE - NO END CUT 6" EXTENDED SHANK LENGTH

Part #	Size	Cut Diameter	Length of Cut	Shank Diameter	Qty.
17189	SA-1L6	1/4	5/8	1/4	1
17239	SA-3L6	3/8	3/4	1/4	1
17289	SA-5L6	1/2	1	1/4	1

SB - CYLINDER SHAPE - WITH END CUT - DOUBLE CUT

Part #	Size	Cut Diameter	Length of Cut	Shank Diameter	Qty.
17409	SB-41	1/16	1/4	1/8	1
17419	SB-42	3/32	7/16	1/8	1
17429	SB-43	1/8	9/16	1/8	1
17439	SB-11	1/8	1/2	1/4	1
17449	SB-12	1/8	5/8	1/4	1
17459	SB-13	5/32	5/8	1/4	1
17469	SB-14	3/16	5/8	1/4	1
17479	SB-51	1/4	3/16	1/8	1
17489	SB-1	1/4	5/8	1/4	1
17499	SB-1L	1/4	1	1/4	1
17509	SB-2	5/16	3/4	1/4	1
17519	SB-3	3/8	3/4	1/4	1
17529	SB-3L	3/8	1	1/4	1
17539	SB-3X	3/8	1-1/2	1/4	1
17549	SB-4	7/16	1	1/4	1
17559	SB-5	1/2	1	1/4	1
17569	SB-6	5/8	1	1/4	1
17579	SB-15	3/4	1/2	1/4	1
17589	SB-16	3/4	3/4	1/4	1
17599	SB-7	3/4	1	1/4	1
17619	SB-8	7/8	1	1/4	1
17629	SB-9	1	1	1/4	1

SA / SB - Cylinder Shape - with End Cut & No End Cut

Premium Carbide Burrs

SC CYLINDER SHAPE - RADIUS END

Application: Surface Milling & Contouring

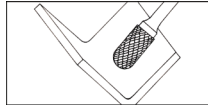

DOUBLE CUT



ALUMA CUT

SD - BALL SHAPE

Application: Contouring, Hole Deburring, Build-up Welding preparation

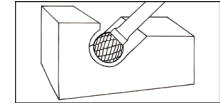
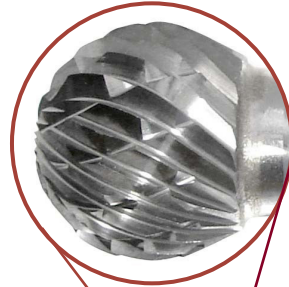

SC - Cylinder Shape - Radius End / SD - Ball Shape

SC - CYLINDER SHAPE - RADIUS END - DOUBLE CUT

Part #	Size	Cut Diameter	Length of Cut	Shank Diameter	Qty.
17659	SC-41	3/32	7/16	1/8	1
17669	SC-42	1/8	9/16	1/8	1
17679	SC-11	1/8	1/2	1/4	1
17689	SC-12	1/8	5/8	1/4	1
17699	SC-52	5/32	1/2	1/8	1
17709	SC-13	5/32	5/8	1/4	1
17719	SC-53	3/16	1/2	1/8	1
17729	SC-14	3/16	5/8	1/4	1
17739	SC-51	1/4	1/2	1/8	1
17749	SC-1	1/4	5/8	1/4	1
17759	SC-1L	1/4	1	1/4	1
17789	SC-2	5/16	3/4	1/4	1
17799	SC-3	3/8	3/4	1/4	1
17809	SC-3L	3/8	1	1/4	1
17829	SC-3X	3/8	1-1/2	1/4	1
17849	SC-4	7/16	1	1/4	1
17859	SC-5	1/2	1	1/4	1
17889	SC-6	5/8	1	1/4	1
17909	SC-15	3/4	1/2	1/4	1
17919	SC-16	3/4	3/4	1/4	1
17929	SC-7	3/4	1	1/4	1
17949	SC-9	1	1	1/4	1

SC - CYLINDER SHAPE - RADIUS END - ALUMA

Part #	Size	Cut Diameter	Length of Cut	Shank Diameter	Qty.
17779	SC-1NF	1/4	5/8	1/4	1
17839	SC-3NF	3/8	3/4	1/4	1
17879	SC-5NF	1/2	1	1/4	1
17899	SC-6NF	5/8	1	1/4	1
17939	SC-7NF	3/4	1	1/4	1

SC-CYLINDER SHAPE - RADIUS END - 6" EXTENDED SHANK LENGTH

Part #	Size	Cut Diameter	Length of Cut	Shank Diameter	Qty.
17769	SC-1L6	1/4	5/8"	1/4	1
17819	SC-3L6	3/8	3/4"	1/4	1
17869	SC-5L6	1/2	1	1/4	1

SD - BALL SHAPE

Part #	Size	Cut Diameter	Length of Cut	Shank Diameter	Qty.
17979	SD-41	3/32	3/32	1/8	1
17989	SD-42	1/8	1/8	1/8	1
18009	SD-11	1/8	1/8	1/4	1
18019	SD-53	3/16	3/16	1/8	1
18029	SD-14	3/16	3/16	1/4	1
18039	SD-51	1/4	1/4	1/8	1
18049	SD-1	1/4	1/4	1/4	1
18079	SD-2	5/16	5/16	1/4	1
18089	SD-3	3/8	3/8	1/4	1
18119	SD-4	7/16	7/16	1/4	1
18129	SD-5	1/2	1/2	1/4	1
18159	SD-6	5/8	5/8	1/4	1
18179	SD-7	3/4	3/4	1/4	1
18199	SD-9	1	1	1/4	1

SD - BALL SHAPE - ALUMA

Part #	Size	Cut Diameter	Length of Cut	Shank Diameter	Qty.
18069	SD-1NF	1/4	1/4	1/4	1
18109	SD-3NF	3/8	3/8	1/4	1
18149	SD-5NF	1/2	1/2	1/4	1
18169	SD-6NF	5/8	5/8	1/4	1
18189	SD-7NF	3/4	3/4	1/4	1

SD - BALL SHAPE - 6" EXTENDED SHANK LENGTH

Part #	Size	Cut Diameter	Length of Cut	Shank Diameter	Qty.
18059	SD-1L6	1/4	7/32	1/4	1
18099	SD-3L6	3/8	5/16	1/4	1
18139	SD-5L6	1/2	7/16	1/4	1

Premium Carbide Burrs

SE - OVAL / EGG SHAPE

Application: Contouring

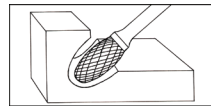

DOUBLE CUT



ALUMA CUT

SE - OVAL/EGG SHAPE

Part #	Size	Cut Diameter	Length of Cut	Shank Diameter	Qty.
18239	SE-41	1/8	7/32	1/8	1
18249	SE-53	3/16	9/32	1/8	1
18259	SE-11	3/16	5/16	1/4	1
18269	SE-51	1/4	3/8	1/8	1
18279	SE-1	1/4	3/8	1/4	1
18299	SE-3	3/8	5/8	1/4	1
18329	SE-5	1/2	7/8	1/4	1
18359	SE-6	5/8	1	1/4	1
18379	SE-7	3/4	1	1/4	1

SE - OVAL/EGG SHAPE - ALUMA

Part #	Size	Cut Diameter	Length of Cut	Shank Diameter	Qty.
18319	SE-3NF	3/8	5/8	1/4	1
18349	SE-5NF	1/2	7/8	1/4	1
18369	SE-6NF	5/8	1	1/4	1
18389	SE-7NF	3/4	1	1/4	1

SE - OVAL/EGG 6" EXTENDED SHANK LENGTH

Part #	Size	Cut Diameter	Length of Cut	Shank Diameter	Qty.
18289	SE-1L6	1/4	3/8	1/4	1
18309	SE-3L6	3/8	19/32	1/4	1
18339	SE-5L6	5/8	7/8	1/4	1

SF - TREE SHAPE RADIUS

Application: Narrow Contours

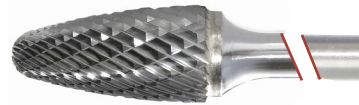
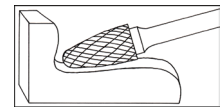

DOUBLE CUT



ALUMA CUT

SF - TREE SHAPE RADIUS

Part #	Size	Cut Diameter	Length of Cut	Shank Diameter	Qty.
18429	SF-41	1/8	1/4	1/8	1
18439	SF-42	1/8	1/2	1/8	1
18449	SF-11	1/8	1/2	1/4	1
18459	SF-53	3/16	1/2	1/8	1
18469	SF-51	1/4	1/2	1/8	1
18479	SF-1	1/4	5/8	1/4	1
18509	SF-3	3/8	3/4	1/4	1
18539	SF-4	7/16	1	1/4	1
18549	SF-13	1/2	3/4	1/4	1
18559	SF-5	1/2	1	1/4	1
18589	SF-6	5/8	1	1/4	1
18609	SF-7	3/4	1	1/4	1
18629	SF-14	3/4	1-1/4	1/4	1
18649	SF-15	3/4	1-1/2	1/4	1

SF - TREE SHAPE RADIUS - ALUMA

Part #	Size	Cut Diameter	Length of Cut	Shank Diameter	Qty.
18499	SF-1NF	1/4	5/8	1/4	1
18529	SF-3NF	3/8	3/4	1/4	1
18579	SF-5NF	1/2	1	1/4	1
18599	SF-6NF	5/8	1	1/4	1
18619	SF-7NF	3/4	1	1/4	1
18639	SF-14NF	3/4	1-1/4	1/4	1

SF - TREE SHAPE RADIUS 6" EXTENDED SHANK LENGTH

Part #	Size	Cut Diameter	Length of Cut	Shank Diameter	Qty.
18489	SF-1L6	1/4	5/8	1/4	1
18519	SF-3L6	3/8	3/4	1/4	1
18569	SF-5L6	1/2	1	1/4	1

SE - Oval/Egg Shape / SF - Tree Shape

Premium Carbide Burrs

SG - POINTED TREE SHAPE

Application: Milling, Acute Angle, Narrow Contouring

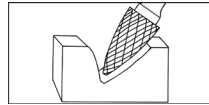
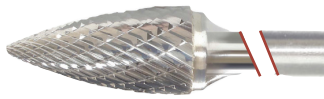

DOUBLE CUT

SG - POINTED TREE SHAPE

Part #	Size	Cut Diameter	Length of Cut	Shank Diameter	Qty.
18679	SG-41	1/8	1/4	1/8	1
18689	SG-42	1/8	5/16	1/8	1
18699	SG-43	1/8	3/8	1/8	1
18709	SG-44	1/8	1/2	1/8	1
18719	SG-53	3/16	1/2	1/8	1
18729	SG-51	1/4	1/2	1/8	1
18739	SG-1	1/4	5/8	1/4	1
18759	SG-2	5/16	3/4	1/4	1
18769	SG-3	3/8	3/4	1/4	1
18789	SG-13	1/2	3/4	1/4	1
18799	SG-5	1/2	1	1/4	1
18819	SG-6	5/8	1	1/4	1
18829	SG-7	3/4	1	1/4	1
18839	SG-15	3/4	1-1/2	1/4	1

SG - POINTED TREE SHAPE 6" EXTENDED SHANK LENGTH

Part #	Size	Cut Diameter	Length of Cut	Shank Diameter	Qty.
18749	SG-1L6	1/4	5/8	1/4	1
18779	SG-3L6	3/8	3/4	1/4	1
18809	SG-5L6	1/2	1	1/4	1

SJ - 60° CONE SHAPE

Application: Acute Angle Matching

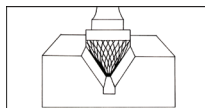

DOUBLE CUT

SJ - 60° CONE SHAPE

Part #	Size	Cut Diameter	Length of Cut	Shank Diameter	Qty.
18979	SJ-42	1/8	3/32	1/8	1
18989	SJ-1	1/4	3/16	1/4	1
18999	SJ-3	3/8	5/16	1/4	1
19009	SJ-5	1/2	7/16	1/4	1
19019	SJ-6	5/8	9/16	1/4	1
19029	SJ-7	3/4	11/16	1/4	1
19039	SJ-9	1	15/16	1/4	1

SH - FLAME SHAPE

Contouring & Milling



DOUBLE CUT

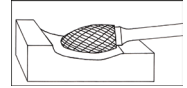

SH - FLAME SHAPE

Part #	Size	Cut Diameter	Length of Cut	Shank Diameter	Qty.
18869	SH-41	1/8	1/4	1/8	1
18879	SH-53	3/16	3/8	1/8	1
18889	SH-1	1/4	5/8	1/4	1
18899	SH-2	5/16	3/4	1/4	1
18919	SH-5	1/2	1-1/4	1/4	1
18939	SH-6	5/8	1-7/16	1/4	1
18949	SH-7	3/4	1-5/8	1/4	1

SH - FLAME SHAPE 6" EXTENDED SHANK LENGTH

Part #	Size	Cut Diameter	Length of Cut	Shank Diameter	Qty.
18909	SH-2L6	5/16	3/4	1/4	1
18929	SF-5L6	1/2	1-1/4	1/4	1

SK - 90° CONE SHAPE

Application: Acute Angle Machining Chamfering, Countersinking



DOUBLE CUT

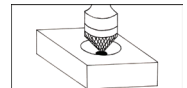

SK - 90° CONE SHAPE

Part #	Size	Cut Diameter	Length of Cut	Shank Diameter	Qty.
19069	SK-42	1/8	1/16	1/8	1
19079	SK-1	1/4	1/8	1/4	1
19089	SK-3	3/8	3/16	1/4	1
19099	SK-5	1/2	1/4	1/4	1
19109	SK-6	5/8	5/16	1/4	1
19119	SK-7	3/4	3/8	1/4	1
19129	SK-9	1	1/2	1/4	1

SL - TAPER SHAPE RADIUS 14° INCLUDED ANGLE

Application: Surface Machining, Narrow Contours and Surfaces



DOUBLE CUT

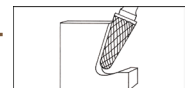

SL - TAPER SHAPE RADIUS 14° INCLUDED ANGLE

Part #	Size	Cut Diameter	Length of Cut	Shank Diameter	Qty.
19159	SL-41	1/8	3/8	1/8	1
19169	SL-42	1/8	1/2	1/8	1
19179	SL-53	3/16	1/2	1/8	1
19189	SL-1	1/4	5/8	1/4	1
19209	SL-2	5/16	7/8	1/4	1
19219	SL-3	3/8	1-1/16	1/4	1
19249	SL-4	1/2	1-1/8	1/4	1
19279	SL-5	5/8	1-3/16	1/4	1
19299	SL-6	5/8	1-5/16	1/4	1
19329	SL-7	3/4	1-1/2	1/4	1

SL - TAPER SHAPE RADIUS 14° INCLUDED ANGLE - ALUMA CUT

19239	SL-3NF	3/8	1-1/16	1/4	1
19269	SL-4NF	1/2	1-1/8	1/4	1
19289	SL-5NF	5/8	1-3/16	1/4	1
19309	SL-6NF	5/8	1-5/16	1/4	1
19329	SL-7NF	3/4	1-1/2	1/4	1

SL - TAPER SHAPE RADIUS 14° INCLUDED ANGLE - EXTRA LENGTH

19199	SL-1L6	1/4	5/8	1/4	1
19229	SL-3L6	3/8	1-1/16	1/4	1
19259	SL-4L6	1/2	1-1/8	1/4	1

Premium Carbide Burrs

SM - POINTED CONE SHAPE

Application: Surface Machining, Narrow Contours

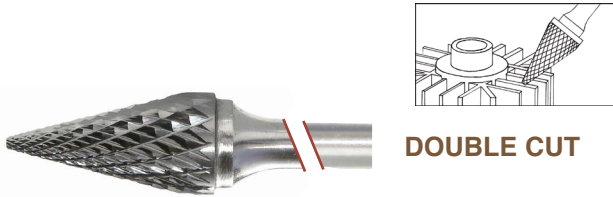

SM - POINTED CONE SHAPE

Product #	Size	Cut Diameter	Length of Cut	Shank Diameter	Included Angle	Qty.
19359	SM-41	1/8	11/32	1/8	12°	1
19369	SM-42	1/8	7/16	1/8	14°	1
19379	SM-43	1/8	5/8	1/8	7°	1
19389	SM-53	3/16	1/2	1/8	16°	1
19399	SM-51	1/4	1/2	1/8	22°	1
19409	SM-1	1/4	1/2	1/4	22°	1
19419	SM-2	1/4	3/4	1/4	14°	1
19429	SM-3	1/4	1	1/4	10°	1
19439	SM-4	3/8	5/8	1/4	28°	1
19449	SM-5	1/2	7/8	1/4	28°	1
19459	SM-6	5/8	1	1/4	31°	1

SN - INVERTED CONE SHAPE

Application: Edge Milling, Rear Machining on difficult to reach areas

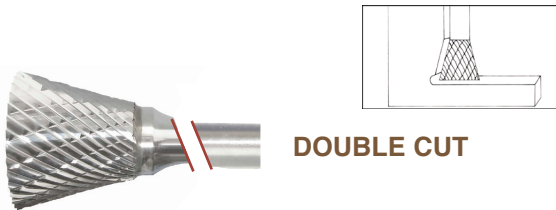

SN - INVERTED CONE SHAPE

Product #	Size	Cut Diameter	Length of Cut	Shank Diameter	Included Angle	Qty.
19489	SN-41	3/32	1/8	1/8	10°	1
19499	SN-42	1/8	3/16	1/8	10°	1
19509	SN-53	3/16	1/4	1/8	10°	1
19519	SN-51	1/4	1/4	1/8	10°	1
19529	SN-1	1/4	5/16	1/4	10°	1
19539	SN-2	3/8	3/8	1/4	13°	1
19549	SN-4	1/2	1/2	1/4	28°	1
19559	SN-6	5/8	3/4	1/4	18°	1
19569	SN-7	3/4	5/8	1/4	30°	1

PREMIUM CARBIDE DOUBLE CUT BURR SETS

Set A Burrs - 9pc.Part #19669
SA-51, SB-51, SC-51, SD-51, SE-51, SF-51, SG-51, SM-51, SN-51

Set B Burrs - 9pc.Part #19649
SA-1, SA-3, SA-5, SC-1, SC-3, SC-5, SF-1, SF-3, SF-5

Set C Burrs - 9pc.Part #19639
SB-1, SB-3, SB-5, SD-1, SD-3, SD-5, SE-1, SE-3, SE-5

Set D Burrs - 9pc.Part #19629
SB-1, SB-3, SB-5, SC-1, SC-3, SC-5SF-1, SF-3, SF-5

Set E Burrs - 8pc.Part #19619
SA-5, SC-5, SD-5, SE-5, SG-5, SH-5, SK-5, SM-5

Set F Burrs - 8pc.Part #19609
SB-5, SC-5, SD-5, SF-5, SG-5, SH-5, SJ-5, SK-5

PREMIUM CARBIDE DOUBLE & ALUMA CUT BURR DISPLAYS



11-1/2" x 6-1/2" (H) x 12" (W)

48 pc. Burrs Display - . . .Part #19689

Double Cut: (1/8 SHANK)
SA-51, SB-51, SC-51, SD-51, SE-51, SF-51, SG-51, SM-51, SN-51

Double Cut: (1/4 SHANK)
SA-1, SA-3, SA-5, SC-1, SC-3, SC-5, SD-1, SD-3, SD-5, SE-1, SE-3, SE-5, SF-1, SF-3, SF-5, SG-1, SG-3, SG-5, SL-4, SL-3, SL-1, SM-5, SM-4, SM-3

Aluma Cut: (1/4 SHANK)
SA-1NF, SA-3NF, SA-5NF, SC-1NF, SC-3NF, SC-5NF, SD-5NF, SD-3NF, SE-5NF, SE-3NF, SF-5NF, SF-3NF, SF-1NF, SL-4NF, SL-3NF



9" x 6-1/2" (H) x 9-1/2"

24 pc. Burrs Display Part #19679

Double Cut: (1/4 SHANK)
SA-5, SA-3, SA-1, SC-5, SC-3, SC-1, SD-5, SD-3, SD-1, SE-5, SE-3, SE-1SF-5, SF-3, SF-1, SG-5, SG-3, SG-1, SL-4, SL-3, SL-1, SM-5, SM-4, SM-3

SM - Pointed Cone Shape / SN - Inverted Cone Shape / Sets , Displays

Magnetic Base Drill & Annular Cutters

Annular Cutters

Type 14 & 14L	M35 Cobalt	94
Type 15C & 15CL	Carbide Tipped	94
Type 13SP & 13LSP	M2 HSS	94

Counter Display High-Speed Steel

Annular Sets	95
Counter Displays	95

Spira-Broach™

MBD 40	Variable Speed Motor	93
MBD 6500	Heavy - Duty	93
MBD 7000	Heavy Duty - w/ Reverse	93



Using the Latest Manufacturing and

Design Technology to provide hole-cutting solutions

for a Wide Range of Industries: • Construction • Steel Fabrication

- Oil & Gas • Mining • Shipyards • Offshore Oil/Gas Rigs • Structural Steelwork
- Automotive • Highway and Railroad Bridgework • Petrochemical Plants • Welding Shops
- Railroads • HVAC • Machinery Installation

Magnetic Base Drill Machines

SPIRA-BROACH™ MAG-BASED DRILLS

MBD 40

The Spira-Broach™ MBD 40 is a light, yet powerful magnetic drill with the ability to cut large diameter holes up to 1-1/2".

Features:

- Cutter capacity 1-1/2"
- Automatic coolant
- Clutch and Overload protection
- Twist Drill Capacity 1/2"
- Carry case, drill chuck and accessories included
- Magnetic adhesion: 1650 lbs.

Technical

Specifications:

- Speed RPM 350 Load
- Speed RPM 610 No Load
- Weight - only 32.2 lbs.
- Max hole cutting capacity: 1/2" dia x 2" deep
- Motor Spec: 110V full load 11A 1100W
230V full load 5A 1100W

Part No.	Size	Qty.
12420	MBD 40	1



MBD 6500 - Heavy Duty

Spira-Broach™ MBD 6500 variable speed Magnetic based drill.

- #### Features:
- Two gear ranges
 - Morse Taper allows for quick conversion to twist drilling
 - Convenient carrying case

Technical

Specifications:

- Power 1.5hp
- Cutter Capacity 2"
- Morse Taper -2
- Speed Ranges - 280/ 500 rpm
- Magnet Adhesion - 2000 lbs.
- Weight - 40 lbs.

Includes:

- Integral lubrication system
- Warranty
- Allen keys
- Safety strap & guard



MBD 7000 - Heavy Duty w/ Reverse

Spira-Broach™ MBD 7000 variable speed Magnetic based drill with reversible motor

- #### Features:
- Reversible motor for tapping
 - Variable Speed Control
 - Morse Taper allows for quick conversion to twist drilling
 - Two gear ranges
 - Convenient carrying case
 - 2-Inch cutter capacity

Part No.	Description	Qty.
17920	MBD 6500	1
17930	MBD 7000	1
00952	Drill Chuck with #2 Morse Taper	1

Portable Magnetic Base Drills - Spira-Broach™

Annular Cutters

SPIRA-BROACH™ ANNULAR CUTTERS

Types 13SP, Type 13LSP M2 High-Speed Steel Cutters

- High tungsten content increases abrasion resistance resulting in a tough tool with long lasting durability.
- M2 excellent all purpose capability.**

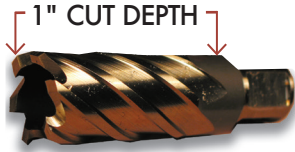

Type 13SP
M2, Hi-Tungsten



Type 14
COBALT



Type 15C
Carbide Tipped

Type 14, Types 14L Cobalt Cutters Gold Finish

- Cobalt added to increase heat resistance.
- M35 Increased hardness for tough jobs.**



Type 13LSP
M2, Hi-Tungsten



Type 14L
COBALT



Type 15CL
Carbide Tipped

Type 15C & 15CL Cobalt CT Spira-Broach Carbide Annular Cutters

- Spira-Broach carbide tipped cutters outperform high-speed steel annular cutters when drilling harder materials such as stainless steel, castings and high grade wear resistant steel.

Annular Cutters - Spira-Broach™ M2 M35 & M42

Type 13SP M2 Part #	Type 14 M35 Part #	Type 15C Carbide Tipped Part #	Cutter Diameter	Qty.
16311	16631	15651	7/16"	1
16321	16641	15661	1/2"	1
16331	16651	15671	9/16"	1
16341	16661	15681	5/8"	1
16351	16671	15691	11/16"	1
16361	16681	15701	3/4"	1
16371	16691	15711	13/16"	1
16381	16701	15721	7/8"	1
16391	16711	15731	15/16"	1
16401	16721	15741	1"	1
16411	16731	15751	1-1/16"	1
16421	16741	15761	1-1/8"	1
16431	16751	15771	1-3/16"	1
16441	16761	15781	1-1/4"	1
16451	16771	15791	1-5/16"	1
16461	16781	15801	1-3/8"	1
16471	16791	15811	1-7/16"	1
16481	16801	15821	1-1/2"	1
16491	16811	15831	1-9/16"	1
16501	16821	15841	1-5/8"	1
16511	16831	15851	1-11/16"	1
16521	16841	15861	1-3/4"	1
16531	16851	15871	1-13/16"	1
16541	16861	15881	1-7/8"	1
16551	16871	15891	1-15/16"	1
16561	16881	15901	2"	1
16571	16891	15911	2-1/16"	1
16581	16911	15921	2-1/8"	1
16591	16921	15931	2-3/16"	1
16601	16931	15941	2-1/4"	1
16611	16941	15951	2-5/16"	1
16621	16951	15961	2-3/8"	1

Type 13LSP M2 Part #	Type 14L M35 Part #	Type 15CL Carbide Tipped Part #	Cutter Diameter	Qty.
16312	16632	15652	7/16"	1
16322	16642	15662	1/2"	1
16332	16652	15672	9/16"	1
16342	16662	15682	5/8"	1
16352	16672	15692	11/16"	1
16362	16682	15702	3/4"	1
16372	16692	15712	13/16"	1
16382	16702	15722	7/8"	1
16392	16712	15732	15/16"	1
16402	16722	15742	1"	1
16412	16732	15752	1-1/16"	1
16422	16742	15762	1-1/8"	1
16432	16752	15772	1-3/16"	1
16442	16762	15782	1-1/4"	1
16452	16772	15792	1-5/16"	1
16462	16782	15802	1-3/8"	1
16472	16792	15812	1-7/16"	1
16482	16802	15822	1-1/2"	1
16492	16812	15832	1-9/16"	1
16502	16822	15842	1-5/8"	1
16512	16832	15852	1-11/16"	1
16522	16842	15862	1-3/4"	1
16532	16852	15872	1-13/16"	1
16542	16862	15882	1-7/8"	1
16552	16872	15892	1-15/16"	1
16562	16882	15902	2"	1
16572	16892	15912	2-1/16"	1
16582	16912	15922	2-1/8"	1
16592	16922	15932	2-3/16"	1
16602	16932	15942	2-1/4"	1
16612	16942	15952	2-5/16"	1
16622	16952	15962	2-3/8"	1

Pilot Pins for 1" Cut Depth		
Part #	Description	Size
00902	1/4" dia. pin fits One inch Depth cutters 1/2" & Larger	PP1/4" x 1"
13710	11/64" dia. Pin fits 7/16" --- 1" Depth cutter	

Pilot Pins for 2" Cut Depth		
Part #	Description	Size
00903	1/4" dia. pin fits Two inch Depth cutters 1/2" & Larger	PP1/4" x 2"
13720	11/64" dia. Pin fits 7/16" --- 2" Depth cutter	

Pilot Pins for Type 15C - 1" Cut Depth		
Part #	Description	Size
15601	1/4" dia. pin for 1/2" - 5/8"	PP1/4" x 1"
15611	5/16" dia. pin for 11/16" - 2-3/8"	PP5/16" x 1"
15621	7/16" dia. pin for 7/16"	PP7/16" x 1"

Pilot Pins for Type 15CL - 2" Cut Depth		
Part #	Description	Size
15602	1/4" dia. pin for 1/2" - 5/8"	PP1/4" x 2"
15612	5/16" dia. pin for 11/16" - 2-3/8"	PP5/16" x 2"
15622	7/16" dia. pin for 7/16"	PP7/16" x 2"

Annular Cutters

SPIRA-BROACH™ ANNULAR CUTTERS & COUNTER DISPLAY

Spira-Broach™ Annular Cutters

These unique cutters reduce time and power requirements by cutting larger diameter holes at the periphery leaving solid slug in the center.

SPIRA-BROACH Cutters

- Give the lowest cost per hole
- Cut on curved surfaces
- Allow overlapping cuts on existing holes
- Stay sharp much longer
- Leaves a burr-free hole



SB-5 1" & 2" LENGTH

9/16", 11/16", 13/16", 15/16", 1-1/16"

Part #	Pin	Type	Metal
16901	1" Pin	14	M42
16902	2" Pin	14L	M42
16624	1" Pin	13SP	M2 HSS
16629	2" Pin	13LSP	M2 HSS
15971	1" Pin	15-C	Hi-Carbon
15972	2" Pin	15-CL	Hi-Carbon



ANNULAR CUTTER DISPLAYS

Annular Cutters

- Compact metal case attractively displays annular cutters.
- Scratch proof Lexan front reduces pilferage and keeps merchandise clean.
- Includes: 1" pins and 2" pins for each size

ANNULAR CUTTERS COUNTER DISPLAY

1/2", 9/16", 5/8", 11/16", 3/4", 13/16", 7/8", 15/16", 1", 1-1/16"

Part#	Size	Type	Qty.
00943	M-42	SB-20	15
00944	M-35	SB-20HS	14
00949	M-2 HSS	SB-20SP	13SP
15981	Carbide Tipped	SB-20	15-C

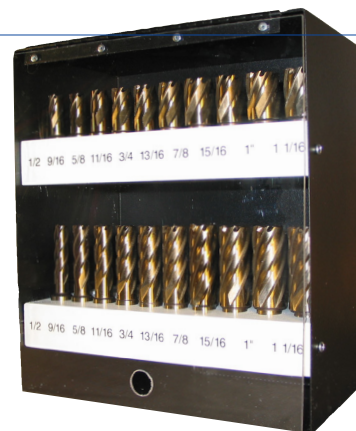

Specialty Tools Index

Acrylic Drills

Type 183-AG106

Auger Bits

Type 950, 951 952 & 953.....102

Bolt Remover

Bolt Extractors Set99

Type 420 Spiral.....98

Type 421-AG Square.....98

Brad Point Drills

Type 16-AG103

Type 16-AG Sets.....103

Carbide Tipped Holecutters

Type CHC-AG107

Type CHD-AG107

Type CHC-QR107

Type HC-3QR Set107

Type Ext OAL- 6-1/4"107

Hanging Display of CHC-QR107

Countersinks

Type 82-AG Piloted108

Type 82-AG Pilotless108

Type 90-AG Deburring108

Technical Diagram108

Type 83-AG 6-Flute109

Combined Drills & Countersinks

Type 296109

Type 296-XL.....109

Combined Drill & Countersinks Set ..109

Cutting Tool Lubricant

Type 11-AG106

Drywall Bits For Cutouts

Type 180-GP Black & Gold102

Type 180-SA Bright Finish102

Glass & Tile Drills

Type 62699

Hard Steel Drills

Type 602 Carbide Tipped106

Type 602-C Solid Carbide106

Reamers

Type 50-AG Standard Flute - Car Reamers 100

Type 51-AG Fast Spiral - Car Reamers ..100

Type 51-AGM Fast Spiral Mechanics Length  101

Type 52-AG Hex Nut Bridge Length...100

Type 53-AG Hex Nut Car Length...100

Type 54-AG Straight Flute - Taper Shank ..101

Type 55-AG Spiral Flute - Taper Shank ...101

Hole Hog™

Type 134-AG Hole Hog™ & Sets ...102

Step Reamers & Sets

Type 78-GR Gold Oxide101

Type 78-ZR Zirconium Nitride101

Left-Hand Spiral Drills

Type 420-AL Carded.....97

Type 190-AL97

Type 190-AL Sets.....97

Left-Hand Screw Machine

Type 135-AL97

Left-Hand **VORTEX**^{POINT} & Spiral Extractor

Type 175-VTL 97

All Purpose Heavy Duty

Type 214105

Pilot Drills

Type 185105

Step Drill Bits

Type 175-VT **VORTEX**^{POINT} 103

Power Bits

Type 935103

Type 935 Sets103

Type QR-AG Extensions 3", 6", 12".....103

Sheeters Drills

Type 224106

Step Drills - Multi-Diameter

Type B78-AG Gold Oxide.....104

Type B78-AGN Titanium Nitride.....104

Type B78-ACN Titanium Carbon Nitride 104

Type 78-QR104

Type 78-QRN104

Step Drill Sets.....104

Twin End Drills

Type 140-G105

Type 140105

Weldout™ Spotweld Drills & Sets

Type 186 Weldout™ Spot weld ...110

Type 187 Weldout™ Spot weld ...110

Type 187-DN TiN Coated110

Type 187-B Carbide ALTiN Coated 110

Type 187 WO-4 Set110

Type 186 WO-6 Set110



Specialty Tools



LEFT-HAND SPIRAL JOBBER LENGTH, LEFT-HAND **VORTEX-POINT™**

Type 190-AL Magnum Super Premium - Left Hand Spiral

- Special Hi-Molybdenum tool steel.
- 135° split point for fast penetration and accurate starting without center punch.
- Precision ground point, flutes, body, clearance and drill diameter for the ultimate in accuracy and performance.
- Ideal for removing broken studs.



TYPE 190-AL LEFT-HAND SPIRAL SETS

Part #	Diameter Inches	OAL Inches	Flute Length Inches	Qty. per/pack
92430	1/16"	1-7/8	7/8	6
23150	5/64	2"	1"	6
89290	3/32"	2-1/4	1-1/4	6
23160	7/64	2-5/8	1-1/2	6
92440	1/8"	2-3/4	1-5/8	6
92441	9/64	2-7/8	1-3/4	6
23170	5/32"	3-1/8	2"	6
92442	11/64	3-1/4	2-1/8	6
92450	3/16"	3-1/2	2-5/16	6
92443	13/64	3-5/8	2-7/16	6
92444	7/32"	3-3/4	2-1/2	6
92451	15/64	3-7/8	2-5/8	6
92460	1/4"	4"	2-3/4	6
92452	17/64	4-1/8	2-7/8	6
92453	9/32"	4-1/4	2-15/16	6
23180	19/64	4-3/8	3-1/16	3
92470	5/16"	4-1/2	3-3/16	3
92471	21/64	4-5/8	3-5/16	3
92472	11/32"	4-3/4	3-7/16	3
92473	23/64	4-7/8	3-1/2	3
92480	3/8"	5"	3-5/8	3
92481	25/64	5-1/8	3-3/4	3
92482	13/32"	5-1/4	3-7/8	3
92483	27/64	5-3/8	3-15/16	3
92490	7/16"	5-1/2	4-1/16	3
92491	29/64	5-5/8	4-3/16	3
92492	15/32"	5-3/4	4-5/16	3
92493	31/64	5-7/8	4-3/8	3
92500	1/2"	6"	4-1/2"	3

8 Pc.		
Part #	Description of Sizes	Qty of each
87650	LF-8 1/16-1/2" by 16ths	1

12 Pc.		
Part #	Description of Sizes	Qty of each
87651	LF-12 1/16-5/16" by 32nds, 3/8, 7/16 & 1/2"	1

13 Pc.		
Part #	Description of Sizes	Qty of each
87652	LF-13 1/16-1/4" by 64ths	1

15 Pc.		
Part #	Description of Sizes	Qty of each
87654	LF-15 1/16 - 1/2" by 32nds	1

17 Pc.		
Part #	Description of Sizes	Qty of each
87853	LF-17 1/16-1/4" by 64ths, 5/16-1/2" by 16ths	1

29 Pc.		
Part #	Description of Sizes	Qty of each
87854	LF-29 1/16-1/2" by 64ths	1

29 Pc. - Ultra Dex		
Part #	Description of Sizes	Qty of each
87859	LF-29P 1/16-1/2" by 64ths	1

Left-Hand Screw Machine Length 135° Split Point, 3-Flats on Shank 3/16" & Larger

Type 135-AL Black & Gold

- Ideal for removing broken studs in tight areas.
- Left hand spiral drills often remove bolt without the need for an extractor.



135-AL Black/Gold Part #	Diameter Inches	Overall Length Inches	Flute Length Inches	Qty. per/pack
35214	3/32"	1-3/4"	3/4"	6
35234	1/8"	1-7/8"	7/8"	6
35254	5/32"	2-1/16"	1"	6
35274	3/16"	2-3/16"	1-1/8"	6
35294	7/32"	2-3/8"	1-1/4"	6
35314	1/4"	2-1/2"	1-3/8"	6
35334	9/32"	2-11/16"	1-1/2"	3
35354	5/16"	2-13/16"	1-5/8"	3
35374	11/32"	3"	1-11/16"	3
35394	3/8"	3-1/8"	1-13/16"	3
35414	13/32"	3-5/16"	1-15/16"	3
35434	7/16"	3-7/16"	2-1/16"	3
35454	15/32"	3-5/8"	2-1/8"	3
35474	1/2"	3-3/4"	2-1/4"	3

Type 175-VTL

Left-Hand **VORTEX-POINT™** & Spiral Hi-Carbon Screw Pipe Extractor



- Unique tip geometry reduces heat generation & cutting tool wear increasing tool life.
- Remove broken screws, bolts threaded parts, and pipes.

Part #	Diameter Inches	OAL Inches	Flute Length Inches
35582	1/8"	2-1/2"	1-7/16"
35622	3/16"	3"	2-7/8"
35662	1/4"	3-1/2"	2"
35702	5/16"	4"	2-1/2"
35742	3/8"	4-1/4"	2-11/16"

TYPE 420 & **VORTEX-POINT™** SET

LEFT-HAND **VORTEX-POINT™** & SPIRAL EXTRACTOR

Part #	Description of Sizes	Qty of each
35852	BR-10VT EX 1, 2, 3, 4, 5 + 1/8", 3/16" 1/4", 5/16", 3/8"	1

Broken Bolt Remover Combo

Type 420-AL

- Carded left hand drill combined with spiral style screw extractor is ideal for removing broken studs.



Part #	Screw Extractor Number	Description of Sizes	Qty of each
30137	EX-1	3/32" LH drill	1
30147	EX-2	1/8" LH drill	1
30157	EX-3	3/16" LH drill	1
30167	EX-4	1/4" LH drill	1
30177	EX-5	5/16" LH drill	1

PRODUCT: TIPS

Bolt Remover Sets Include BOTH Left-Hand Spiral Drills and Bolt/Screw Extractors



TYPE 421-USA SET

SQUARE EXTRACTOR		
Part #	Description of Sizes	Qty of each
35484	BR-10SQ E 1, 2, 3, 4, 5 + 3/32", 1/8" 3/16", 1/4", 5/16"	1
35491	BR-10SQX E 1, 2, 3, 4, 5 + 1/8" 3/16", 1/4", 5/16", 3/8"	1

Hi-Carbon Specialty Tools

HI-CARBON SCREW, STUD & PIPE EXTRACTORS

Type 420

Screw & Pipe Extractors Hi-Carbon Steel - Spiral Style

- Remove broken screws, bolts, threaded parts, and pipes.
- Broken piece is extracted with out damage to threads.



To remove the broken threaded part: Drill a hole in the end of the broken part (left hand spiral heavy duty drills are recommended for this drilling operation), insert extractor, then turn counterclockwise using a wrench on the exposed end of the extractor.

TYPE 420 SCREW & PIPE EXTRACTORS

Part #	Screw Extractor Number	To remove Diameter of Screw	Diameter. of Screw Extractor Shank Point		Drill Size	No. per/pack
57100	EX-1	3/32" to 5/32"	1/8"	.060	5/64"	5
57110	EX-2	5/32" to 7/32"	3/16"	.080	7/64"	5
57120	EX-3	7/32" to 9/32"	1/4"	1/8	5/32"	5
57130	EX-4	9/32 to 3/8" and 1/8" pipe	5/16"	3/16	1/4"	5
57140	EX-5	3/8 to 5/8" and 1/4" pipe	7/16"	1/4	17/64"	5
57150	EX-6	5/8 to 7/8" and 3/8" pipe	5/8"	3/8	13/32"	1
57160	EX-7	7/8 to 1-1/8" and 1/2" pipe	7/8"	15/32	17/32"	1
57170	EX-8	1-1/8 to 1-3/8 and 3/4" pipe	11/32"	3/4	13/16"	1
57180	EX-9	1-3/8" up and 1" pipe	1-9/32"	1	1-1/8"	1

TYPE 420 SCREW & PIPE EXTRACTORS - CARDED

57107	EX-1	3/32 to 5/32"	1/8	.060	5/64"	1
57117	EX-2	5/32 to 7/32"	3/16	.080	7/64"	1
57127	EX-3	7/32 to 9/32	1/4	1/8	5/32"	1
57137	EX-4	9/32 to 3/8 and 1/8" pipe	5/16	3/16	1/4"	1
57147	EX-5	3/8 to 5/8 and 1/4" pipe	7/16	1/4	17/64"	1

Type 421-AG

Studout™ Screw, Stud and Pipe Extractors - Square Style Forged Hi-Carbon Steel



- The square shape of these extractors gives the tools the ability to remove broken bolts, screws, and pipes with minimum deformation of the broken part.
- These extractors will not chew up or expand the object being removed.

To remove the broken threaded part: Drill a hole in the end of the broken part (left hand spiral heavy duty drills are recommended for this drilling operation), insert extractor, then turn counterclockwise using a wrench on the exposed end of the extractor.

TYPE 421-AG STUDOUT™ SCREW, STUD & PIPE EXTRACTOR

Part #	Screw Extractor Number	To remove Diameter of Screw	Diameter. of Screw Extractor Shank Point		Drill Size	No. per/pack
70760	E-1	3/16" - 9/32"	3/16"	1/8"	1/8"	5
70770	E-2	9/32" - 11/32"	1/4"	11/64"	3/16"	5
70780	E-3	11/32" - 1/2"	5/16"	7/32"	1/4"	5
70800	E-4	1/2" - 3/4"	3/8"	9/32"	5/16"	5
70810	E-5	5/8" - 7/8"	7/16"	21/64"	3/8"	5
70820	E-6	7/8" - 1"	1/2"	7/16"	1/2"	1
70830	E-7	1" - 1-1/4"	5/8"	1/2"	9/16"	1
70860	E-8	1-1/8" - 1-1/2"	3/4"	9/16"	5/8"	1
70870	E-9	1-1/4" - 1-3/4"	7/8"	5/8"	11/16"	1

Type 421-USA

Screw, Stud & Pipe Extractors - Square Style Forged Hi-Carbon Steel

- The square shape of these extractors gives the tools the ability to remove broken bolts, screws, and pipes with minimum deformation of the broken part.
- These extractors will not chew up or expand the object being removed.



To remove the broken threaded part: Drill a hole in the end of the broken part (left hand spiral heavy duty drills are recommended for this drilling operation), insert extractor, then turn counterclockwise using a wrench on the exposed end of the extractor.

TYPE 421-USA SCREW, STUD & PIPE EXTRACTOR

Part #	Screw Extractor Number	To remove Diameter of Screw	Diameter. of Screw Extractor Shank Point		Drill Size	No. per/pack
20890	E-1	3/16" - 9/32"	3/16"	1/8"	1/8"	5
20900	E-2	9/32" - 11/32"	1/4"	11/64"	3/16"	5
20910	E-3	11/32" - 1/2"	5/16"	7/32"	1/4"	5
20920	E-4	1/2" - 3/4"	3/8"	9/32"	5/16"	5
20930	E-5	5/8" - 7/8"	7/16"	21/64"	3/8"	5
20940	E-6	7/8" - 1"	1/2"	7/16"	1/2"	1
20950	E-7	1" - 1-1/4"	5/8"	1/2"	9/16"	1
20960	E-8	1-1/8" - 1-1/2"	3/4"	9/16"	5/8"	1
20970	E-9	1-1/4" - 1-3/4"	7/8"	5/8"	11/16"	1

Specialty Tools

BOLT EXTRACTOR SETS / GLASS TILE

Type 420 -Bolt Extractor Set Type 421-AG -Bolt Extractor Set

- Fast and easy stud removal
- Left-hand spiral drills often eliminate the need for use of extractor.
- Drill loosens bolt stud with counter clockwise rotation.
- 135° split point for fast penetration and accurate starting without center punch.
- Most broken studs are work hardened during the breaking process.

TYPE 420 BOLT EXTRACTOR SETS - SPIRAL EXTRACTOR

SE-4N - Type 420

Part No.	Description of Sizes	Qty of each
47170	EX 2, 3, 4 & 5	1

SE-5N - Type 420

Part No.	Description of Sizes	Qty of each
47180	EX 1, 2, 3, 4 & 5	1

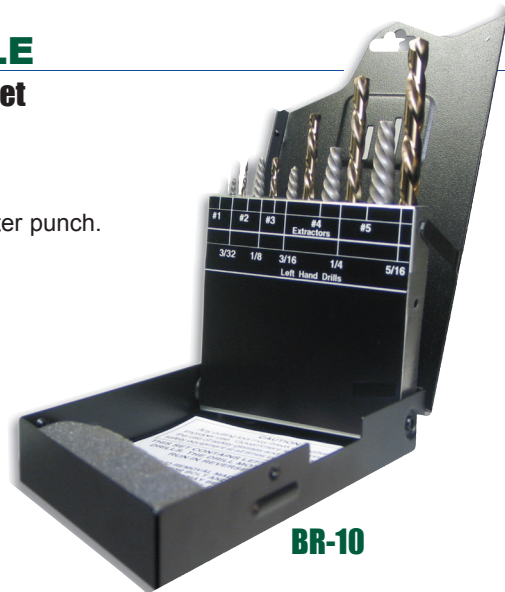

BR-10

TYPE 420 BOLT EXTRACTOR SETS - LEFT HAND DRILL

BR-8 - Type 420 & 190-AL

Part No.	Description of Sizes	Qty of each
88550	EX 1, 2, 3, 4 + 3/32, 1/8, 3/16 & 1/4	1

BR-10 - Type 420 & 190-AL

Part No.	Description of Sizes	Qty of each
58510	EX 1, 2, 3, 4 & 5 + 3/32, 1/8, 3/16, 1/4, 5/16	1

TYPE 421-AG BOLT EXTRACTOR SETS

SQE-4 - Type 421-AG

Part No.	Description of Sizes	Qty of each
70840	EX 2, 3, 4 & 5	1

TYPE 421-AG BOLT EXTRACTOR SETS - LEFT HAND DRILL

BR-8SQ - Type 421-AG & 190-AL

Part No.	Description of Sizes	Qty of each
70850	EX 1, 2, 3 & 4 + 1/8, 3/16, 1/4 & 5/16	1

GLASS & TILE DRILLS

Type 626

Carbide Tipped with Spear Point

- Designed for drilling in glass, tile, mirrors and ceramic materials.
- Spear point allows clean penetration with reduced cutting pressure and breakout.
- Carbide tip insures long tool life.



TYPE 626 CARBIDE TIPPED

Part #	Size Inches
56510	1/8"
56520	5/32"
56530	3/16"
56540	1/4"
56550	5/16"
56560	3/8"
56570	1/2"
56580	4pc. GT-4 1/8", 3/16", 1/4", 5/16"

Individually packaged in clear hanging tubes.

Hole Expansion Tools & Sets

CAR REAMERS & HEX NUT REAMERS

Type 50-AG

Car Reamers, Standard Flute 3-Flats on Shank

- All tools are constructed with left-hand spiral and right-hand cut.
- For use in enlarging previously formed or drilled holes.
- These reamers are especially designed for the reaming of structural steel plates commonly found in truck frames, rail cars, bridges, and pressure vessels.



Part#	Shank Dia.	Overall Length	Dia. Inches	Point Dia.	Min. Starting Hole Size	Qty. per/Pk
06390	3/8"	4-5/8"	*3/8"	0.244	9/32"	1
06400	1/2"	5-7/8"	*1/2"	0.291	5/16"	1
06410	1/2"	5-7/8"	*3/8"	0.291	5/16"	1
06420	1/2"	6-3/8"	*5/8"	0.323	11/32"	1
06430	1/2"	6-3/8"	11/16"	0.385	13/32"	1
06440	1/2"	6-7/8"	*3/4"	0.416	7/16"	1
06450	1/2"	6-7/8"	13/16"	0.478	1/2"	1
06460	1/2"	6-7/8"	7/8"	0.510	17/32"	1
06470	1/2"	6-7/8"	15/16"	0.595	19/32"	1
06480	1/2"	6-7/8"	1"	0.604	5/8"	1
06504	1/2"	6-7/8"	1-1/16"	0.635	21/32"	1

Part#	Shank Dia.	Overall Length	Dia. Inches	Point Dia.	Min. Starting Hole Size	Qty. per/Pk
06514	1/2"	6-7/8"	1-1/8"	0.670	11/16"	1
06524	1/2"	6-7/8"	1-3/16"	0.710	3/4"	1
06484	1/2"	6-7/8"	1-1/4"	0.729	3/4"	1
06534	3/4"	6-7/8"	1-5/16"	0.785	13/16"	1
06544	3/4"	6-7/8"	1-3/8"	0.820	7/8"	1
06554	3/4"	6-7/8"	1-7/16"	0.860	29/32"	1
06564	3/4"	6-7/8"	1-1/2"	0.900	15/16"	1

SET TYPE 50-AG Includes
12270 *4PC. CR-4SP 3/8", 1/2", 5/8", 3/4"

Type 51-AG

Car Reamers - Fast Spiral Hole Buster™ Super Premium 3-Flats on Shank

- Special Hi-Tungsten tool steel, gold surface treated body and clearance for maximum lubricity.
- The 51-AG, with the fast spiral, is the more aggressive of the two styles. It also will fit the needs of users who prefer a stop collar.



Part#	Shank Dia.	Overall Length	Dia. Inches	Point Dia.	Min. Starting Hole Size	Qty. per/Pk
06381	5/16"	4-5/8"	*5/16"	0.182	3/16"	1
06391	3/8"	4-5/8"	*3/8"	0.244	1/4"	1
06501	7/16"	5-7/8"	*7/16"	0.260	9/32"	1
06401	1/2"	5-7/8"	*1/2"	0.291	5/16"	1
06411	1/2"	5-7/8"	9/16"	0.291	5/16"	1
06421	1/2"	6-3/8"	*5/8"	0.323	11/32"	1
06432	1/2"	6-3/8"	0.652	0.385	13/32"	1
06431	1/2"	6-3/8"	11/16"	0.385	13/32"	1
06441	1/2"	6-7/8"	*3/4"	0.416	7/16"	1
06531	1/2"	6-7/8"	0.776	0.416	7/16"	1
06451	1/2"	6-7/8"	13/16"	0.478	1/2"	1
06461	1/2"	6-7/8"	7/8"	0.510	17/32"	1
06471	1/2"	6-7/8"	15/16"	0.595	19/32"	1

Part#	Shank Dia.	Overall Length	Dia. Inches	Point Dia.	Min. Starting Hole Size	Qty. per/Pk
06481	1/2"	6-7/8"	1"	0.604	5/8"	1
06491	1/2"	6-7/8"	1-1/16"	0.635	21/32"	1
06541	1/2"	6-7/8"	1-1/8"	0.670	11/16"	1
06551	1/2"	6-7/8"	1-3/16"	0.710	3/4"	1
06482	1/2"	6-7/8"	1-1/4"	0.729	3/4"	1
06561	3/4"	6-7/8"	1-5/16"	0.785	13/16"	1
06571	3/4"	6-7/8"	1-3/8"	0.820	7/8"	1
06581	3/4"	6-7/8"	1-7/16"	0.860	29/32"	1
06591	3/4"	6-7/8"	1-1/2"	0.900	15/16"	1

SETS TYPE 51-AG Includes
12271 *4PC. CR-4FS 3/8", 1/2", 5/8", 3/4"
12281 *4PC. SM-4FS 5/16, 3/8", 7/16", 1/2"



Type 52-AG - Bridge Length Type 53-AG - Car Length Hex Nut Reamers Black & Gold Finish HSS-Spiral Flute

- Designed for aligning and enlarging holes in structural steel applications.
- Gold treated for maximum lubricity.

TYPE 52-AG BRIDGE LENGTH

Part #	Diameter Inches	Hex Shank Inches	Flute Length	Overall Length	Qty. per/Pk
20480	9/16"	1-1/16"	5-1/8	6-7/8	1
20490	5/8"	1-1/16"	6-1/8	7-7/8	1
20510	11/16"	1-1/16"	7-1/8	9-1/4	1
20520	3/4"	1-1/4"	7-3/8	9-3/8	1
20530	13/16"	1-1/4"	7-3/8	9-3/8	1
20540	7/8"	1-7/16"	7-3/8	9-3/8	1
20550	15/16"	1-7/16"	7-3/8	9-3/8	1
20560	1"	1-7/16"	7-3/8	9-3/8	1
20570	1-1/16"	1-5/8"	7-3/8	9-3/8	1
20500	1-1/8"	1-5/8"	7-3/8	9-3/8	1
20580	1-3/16"	1-13/16"	7-3/8	9-3/8	1
20590	1-5/16"	2"	7-3/8	10	1
21120	1-3/8"	2"	7-3/8	10	1
21130	1-7/16"	2"	7-3/8	10	1
21140	1-1/2"	2"	7-3/8	10	1
21150	1-9/16"	2"	7-3/8	10	1
21160	1-5/8"	2"	7-1/2	10	1

TYPE 53-AG CAR LENGTH

Part #	Diameter Inches	Hex Shank Inches	Flute Length	Overall Length	Qty. per/Pk
35580	9/16	1-1/16	4	5-1/2	1
35590	5/8	1-1/16	4-1/2	6	1
35610	11/16	1-1/16	4-1/2	6-3/8	1
35620	3/4	1-1/4	5	7	1
35630	13/16	1-1/4	5	7	1
35640	7/8	1-7/16	5	7	1
35650	15/16	1-7/16	5	7	1
35660	1"	1-7/16	5	7	1
35670	1-1/16	1-5/8	5	7	1
35600	1-1/8	1-5/8	5	7	1
35680	1-3/16	1-13/16	5	7	1
35690	1-5/16	2	5	7-7/8	1

Hole Expansion Tools & Sets

BRIDGE REAMERS & STEP REAMERS & VORTEX-POINT™/REAMER

Type 54-AG - Straight Flute Type 55-AG - Spiral Flute

Bridge Reamers - Straight & Spiral Flutes - Taper Shank High-Speed Steel, Surface Treated

- These special Hi-Tungsten tool steel reamers with gold surface treated body and clearance are designed to be used with Taper shank equipment.
- They are available in both straight and spiral flute configuration and are designed for heavy-duty reaming as encountered in the fabrication of structural steel assemblies, bridge erection, and ship construction.



TYPE 54-AG STRAIGHT FLUTE

Part #	Diameter Inches	Flute Length	Overall Length	Taper Shank	Qty. per/pack
81630	7/16"	4-3/8	8-1/4	#2	1
81640	1/2"	5-1/8	9	#2	1
81650	9/16"	5-1/8	9	#2	1
81660	5/8"	6-1/8	10	#2	1
81670	11/16"	7-1/8	11-3/4	#3	1
81680	3/4"	7-3/8	12	#3	1
81690	13/16"	7-3/8	12	#3	1
81700	7/8"	7-3/8	12	#3	1
81710	15/16"	7-3/8	12	#3	1
81720	1"	7-3/8	12	#3	1
81730	1-1/16"	7-3/8	12	#3	1
81740	1-1/8"	7-3/8	12	#3	1
81750	1-3/16"	7-3/8	12	#3	1
81760	1-1/4"	7-3/8	13	#4	1
81770	1-5/16"	7-3/8	13	#4	1

TYPE 55-AG SPIRAL FLUTE

Part #	Diameter Inches	Flute Length	Overall Length	Taper Shank	Qty. per/pack
83310	7/16"	4-3/8	8-1/4	#2	1
83320	1/2"	5-1/8	9	#2	1
83330	9/16"	5-1/8	9	#2	1
83340	5/8"	6-1/8	10	#2	1
83350	11/16"	7-1/8	11-3/4	#3	1
83360	3/4"	7-3/8	12	#3	1
83370	13/16"	7-3/8	12	#3	1
83380	7/8"	7-3/8	12	#3	1
83390	15/16"	7-3/8	12	#3	1
83400	1"	7-3/8	12	#3	1
83410	1-1/16"	7-3/8	12	#3	1
83420	1-1/8"	7-3/8	12	#3	1
83430	1-3/16"	7-3/8	12	#3	1
83440	1-1/4"	7-3/8	13	#4	1
83450	1-5/16"	7-3/8	13	#4	1

Type 51-AGM

Car Reamers - Fast Spiral Hole Buster™ Super Premium Mechanics Length 3-Flats on Shank



- For use in enlarging previously formed or drilled holes.
- These reamers are especially designed for the reaming of structural steel plates commonly found in truck frames, rail cars, bridges, and pressure vessels.



Part #	Diameter Inches	OAL Inches	Point Diameter	Min. Starting Hole Size	Qty. per/pack
82100	3/8"	4.160	.183	3/16"	1
82120	1/2"	4.625	.245	1/4"	1
82140	5/8"	5.200	.310	5/16"	1
82170	3/4"	5.750	.370	3/8"	1

Type VT&R-8P

VORTEX-POINT™ & Car Reamers Mechanics Length

- VORTEX-POINT™ Split-point design gives accurate starting and its self-centering eliminating the need for the use of a center punch.
- VORTEX-POINT™ Unique tip geometry reduces heat generation & cutting tool wear increasing tool life.
- Type 51-AGM Mechanics Length reamers are especially designed for the reaming of structural steel plates commonly found in truck frames, rail cars, bridges, and pressure vessels.



SET

8 Pc. Ultra Dex

Part #	3/16", 1/4", 5/16", 3/8" + 3/8", 1/2", 5/8", 3/4"	Qty of ea.
82340	VORTEX-POINT™ + Fast Spiral Car Reamer Type 175-VT & 51-UBM	1

Type 78-GR -Gold Oxide Type 78-ZR -White Gold & SETS HSS Step Reamers, 3-Flats on Shank



- Accurately starts, enlarge and deburrs in holes in material up to 1/2" thick.
- 90° notch point starts holes easily.
- Each reamer has five hole enlargement steps.

Gold Oxide - low temperature stress relief that enhances lubricity, reduces friction and increases toughness.

Zirconium Nitride - cutting machining relief that enhances lubricity, reduces friction and increases toughness.



TYPE 78-GR GOLD OXIDE & TYPE 78-ZR WHITE GOLD

78-GR Gold Oxide Part #	78-ZR Zirconium Nitride Part #	Hole Sizes	Range	Shank Sizes	Step Thickness
83710	99940	5	5/16" - 9/16"	3/8"	1/2"
83720	99950	5	9/16" - 13/16"	3/8"	1/2"
83730	99960	5	13/16" - 1-1/16"	3/8"	1/2"

SETS

78-GR Part #	78-ZR Part #	Hole Sizes	Range	Shank Sizes	Step Thickness
83750	99980	3pc.	5 5/16" - 1-1/16"	3/8"	1/2"
83760	99990	2pc.	5 5/16" - 13/16"	3/8"	1/2"



#83750



#99980

Hole Expansion Tools & Sets

STANDARD WOOD AUGERS, HOLE HOG™, DRYWAL BITS

Type 134-AG & Sets

Hole Hog™ 1/2" Shank 4-Flute Core Drill Super Premium, 3-Flats on Shank

- The 4-flute design eliminates the catching and hogging-in experienced with standard S&D drills when breaking through thinner materials such as truck frames.
- These core drills may replace tapered reamers in many applications.



This tool is designed exclusively for enlarging existing holes.

Part #	Diameter Inches	Minimum Starting Hole Size	OAL Inches	Flute Length Inches	Qty. per/pack
22030	3/8"	1/4"	4-5/16"	1-7/8"	1
22040	1/2"	5/16"	4-5/16"	1-7/8"	1
22060	9/16"	3/8"	4-5/16"	1-7/8"	1
22080	5/8"	25/64"	4-5/16"	1-7/8"	1
22100	11/16"	7/16"	4-5/16"	1-7/8"	1
22120	3/4"	15/32"	4-5/16"	1-7/8"	1

TYPE 134-AG SETS

Part# 38880 SP-8HH Set

Contains 1ea:

134-AG Core drill sizes: 3/8", 1/2", 5/8" & 3/4"

175-AG Drill sizes: 1/4", 5/16", 25/64" & 15/32"

Part# 38870 SP-6HHL Set

Contains 1ea:

134-AG Core drill sizes: 1/2", 5/8" & 3/4"

175-AG Drill sizes: 5/16", 25/64" & 15/32"

Part# 38860 SP-6HHS Set

Contains 1ea:

134-AG Core drill sizes: 3/8", 1/2" & 5/8"

175-AG Drill sizes: 1/4", 5/16" & 25/64"



A selection of core drills and companion (minimum starting hole size) pilot drills in a black steel index.

Type 950- 9", Type 951 - 16" Wood Auger Bits Type 952- 18", Type 953 - 24" Wood Auger Bits

- High quality auger bits with hex shanks produced from alloy tool steel.
- For deep drilling wood applications, quickly and easily drill holes in all types of wood products.



TYPE 950 9"

Part #	Flute Length	Description of Sizes
53200	5"	3/8"
53210	5"	1/2"
53220	5"	9/16"
53230	5"	5/8"
53240	5"	11/16"
53250	5"	3/4"
53260	5"	7/8"
53270	5"	15/16"
53280	5"	1"
53290	5"	1-1/8"

TYPE 951 16"

Part #	Flute Length	Description of Sizes
53300	12"	3/8"
53310	12"	1/2"
53320	12"	9/16"
53330	12"	5/8"
53340	12"	11/16"
53350	12"	3/4"
53360	12"	7/8"
53370	12"	15/16"
53380	12"	1"
53390	12"	1-1/8"

TYPE 952 18"

Part #	Flute Length	Description of Sizes
53400	14"	3/8"
53410	14"	1/2"
53420	14"	9/16"
53430	14"	5/8"
53440	14"	11/16"
53450	14"	3/4"
53460	14"	7/8"
53470	14"	15/16"
53480	14"	1"
53490	14"	1-1/8"

TYPE 953 24"

Part #	Flute Length	Description of Sizes
53500	18"	3/8"
53510	18"	1/2"
53520	18"	9/16"
53530	18"	5/8"
53540	18"	11/16"
53550	18"	3/4"
53560	18"	7/8"
53570	18"	15/16"
53580	18"	1"
53590	18"	1-1/8"

DRYWALL BITS FOR CUTOUTS

Type 180-GP - Black & Gold

High-Speed Steel - Guide Point Left-Hand Cut

- Cuts material Up to 1" thick
- Left-hand spiral, Right hand cut.
- For use with Rotozip Spiral saws.

Type 180-SA - Bright Finish

High-Speed Steel - Left-Hand Cut

- Can cut material Up to 1" thick.
- Left hand spiral, Right hand cut.
- For use in Rotozip Spiral saws.
- Cuts a variety of materials from wood to fiberglass.



Type 180-GP

Gold oxide treated body and clearance for maximum lubricity.



Type 180-SA

It is recommended for non-ferrous metals wood and fiberglass.

TYPE 180- GP DRYWALL BITS

Part No	Diameter Inches	Overall Length Inches	Qty per/pack
68000	1/8"	2-1/4"	8
68020	5/32"	2-1/4"	10
68070	1/4"	2-7/8"	2

TYPE 180- SA DRYWALL BITS

Part No	Diameter Inches	Overall Length Inches	Qty per/pack
68030	1/8"	2-1/4"	8
68040	5/32"	2-1/4"	2

CAUTION: Safety glasses and dust mask must be worn at all times when using super Drywall bits.

Specialty Tools

BRAD POINT DRILLS

Type 16-AG

Jobber Length - Burrouter™ Brad Point Super Premium

- These high performance drills made from Hi-Moly tool steel will cut holes in wood or plastics and leave no burr.
- The special BURROUT™ point cuts at the circumference of the hole to avoid the break through burr problems common with standard point drills.

(Sizes 7/16" and 1/2" have 3/8" Reduced Shanks)



Part #	Diameter Inches	Overall Length Inches	Flute Length Inches	Qty. per/pack
01041	5/64	2	1	12
01051	3/32	2 1/4	1 1/4	12
01061	7/64	2 5/8	1 1/2	12
01071	1/8	2 3/4	1 5/8	12
01081	9/64	2 7/8	1 3/4	12
01091	5/32	3 1/8	2	12
01101	11/64	3 1/4	2 1/8	12
01111	3/16	3 1/2	2 5/16	12
01131	7/32	3 3/4	2 1/2	12
01151	1/4	4	2 3/4	12
01191	5/16	4 1/2	3 3/16	6
01231	3/8	5	3 5/8	6
01271	7/16	5 1/2	4 1/16	6
01311	1/2	6	4 1/2	6

TYPE 16-AG BURROUT™ SETS

BF-10

Part #	Description of Sizes	Qty of each
42001	5/64-3/16" by 64ths + 7/32", 1/4"	1

BF-14

Part #	Description of Sizes	Qty of each
42031	5/64-3/16" by 64ths + 7/32, 1/4"-1/2" by 16ths	1

TYPE QR-AG EXTENSIONS

- One handed operation – Simply push your PTA into the extension and it will automatically load and lock the accessory.
- Patented All Hex connection system will hold any 1/4" hex shape including, **Power groove** and **Notched product**.
- Patented all Hex connection system holds the accessory without any wobble or play. Tight fit for a professional feel.
- **Not intended for Impact Tools.** • **Made in the USA.**



Part #	Size	Qty. per/pack
34821	3" Quick Release Extension	1
34831	6" Quick Release Extension	1
34841	12" Quick Release Extension	1

VORTEX-POINT™

Type 175-VT

Mechanic Length, 3-Flat on Shank



Step drill design

3-Flats on Shank eliminates slippage



Mechanic length - Shorter sturdier construction

- Unique tip geometry reduces heat generation & cutting tool wear increasing tool life.
- Easily enlarges existing holes without damaging the point.
- Split-point design gives accurate starting and its self-centering eliminating the need for the use of a center punch.
- Ideal for **Hard steel, Sheet metal, Brass and Acrylics.**

POWER BITS

Type 935

Quick Release 1/4" Hex Shank - Power Bits

- Cuts clean accurate holes in all soft and hard woods plus foam core, plastic, many non-metallic building siding, and foam insulation.

TYPE 935 1/4" HEX SHANK

Part #	Diameter Inches	Qty. per/pack
52005	1/4"	1
52015	5/16"	1
52025	3/8"	1
52035	7/16"	1
52045	1/2"	1
52055	9/16"	1
52065	5/8"	1
52075	11/16"	1
52085	3/4"	1
52095	13/16"	1
52105	7/8"	1
52115	15/16"	1
52125	1 INCH	1
52135	1-1/8"	1
52145	1-1/4"	1
52155	1-3/8"	1
52165	1-1/2"	1

EXTENSIONS

Part #	Size	Qty. per/pack
27555	6"	1
52175	12"	1

TYPE 935 1/4" HEX SHANK SETS

4pc. SET EASY-CUT

One each: 3/8", 1/2", 5/8" & 3/4" in plastic pouch.

Part# 52185

6pc. SET EASY-CUT

One each: 3/8", 1/2", 5/8", 3/4", 7/8" & 1" in plastic pouch.

Part# 52195

13pc. SET EASY-CUT

One each: 1/4", 5/16", 3/8", 7/16", 1/2", 9/16", 5/8", 11/16", 3/4", 13/16", 7/8", 15/16" & 1" in plastic pouch.

Part# 52205

EASY-CUT 6" - 12" EXTENSION

For all bits with 1/4" shanks. For those jobs that require extra reach with Allen wrench.



Part #	Diameter Inches	Qty. per/pack
22573	1/16"	6
22583	5/64"	6
22593	3/32"	6
22603	7/64"	6
22613	1/8"	6
22623	9/64"	6
22633	5/32"	6
22643	11/64"	6
22653	3/16"	6
22663	13/64"	6
22673	7/32"	6
22683	15/64"	6
22693	1/4"	6
22703	17/64"	6
22713	9/32"	6
22723	19/64"	3
22733	5/16"	3
22743	21/64"	3
22753	11/32"	3

Part #	Diameter Inches	Qty. per/pack
22763	23/64"	3
22773	3/8"	3
22783	25/64"	3
22793	13/32"	3
22803	27/64"	3
22813	7/16"	3
22823	29/64"	3
22833	15/32"	3
22843	31/64"	3
22853	1/2"	3

TYPE 175-VT SETS

22863	VT-13	1/16" - 1/4" by 64ths
22873	VT-15	1/16" - 1/2" by 32nd
22883	VT-21	1/16" - 3/8" by 64ths
22893	VT-29	1/16" - 1/2" by 64ths
22903	VT-29P	1/16" - 1/2" by 64ths
22913	VT-29PO	1/16" - 1/2" by 64ths

Call Toll Free

1.800.328.4655

STEP DRILLS ULTRA BIT™ MULTI-DIAMETER

Made in the U.S.A



Type B78-AG Gold Oxide, 3-flats on Shank - Blister pak

- Special Axial and Radial flute design increases work piece penetration.
- Dual flute construction drills clean accurate holes in thin materials, quickly and easily.

Type B78-AGN Titanium Nitride, 3-flats on Shank - Blister pak

- Titanium nitride coated tools last six times longer than uncoated tools.
- Cutting edge stays sharper longer.
- Titanium nitride coating reduces friction.

Type B78-ACN Titanium Carbon Nitride, 3-flats on Shank - Blister pak

- 2 - 4x the tool life of Titanium Nitride coated tools.
- Improved lubricity for better performance in steel and aluminum.
- Twice as hard as titanium nitride coating.

Quick Release - Ultra Bit™ Multi-Diameter

Type 78-QR Gold Oxide

- Use for all thin metals, rigid plastics, wood or composite materials with a thickness equal to or less than the step thickness.
- Split point self centers and easily starts with no pilot hole required.

Type 78-QRN Titanium Nitride Coated

- Titanium nitride coated tools last six times longer than uncoated tools.
- Cutting edge stays sharper longer.
- Titanium nitride coating reduces friction.

TYPE B78-AG, B78-AGN, B78-ACN 3-FLATTED SHANK

B78-AG Gold Oxide Part #	B78-AGN Titanium Nitride Part #	B78-ACN Titanium Carbon Nitride Part #	Size	Hole Sizes	No. Range	Shank Size	Step Increments	Step Thickness
45401	45701	65301	1	13	1/8 - 1/2"	1/4"	1/32"	1/8
45441	45751	65311	2	8	1/4 - 1"	3/8"	1/16"	5/32
45431	45731	65321	3	9	1/4 - 3/4"	3/8"	1/16"	5/32
45411	45711	65331	4	6	3/16 - 1/2"	1/4"	1/16"	3/8
45481	45741	65341	7	11	1/4 - 7/8"	3/8"	1/16"	1/16
45421	45721	65351	8	12	3/16 - 7/8"	3/8"	1/16"	1/8
45501	-----	-----	9	3	1/4 - 1-7/32"	3/8"	7/8"	-----
45471	45771	65361	11	2	1/4 - 1-1/8"	3/8"	27/64"	9/64
*45461	45791	65371	12	5	1/4 - 1-3/8"	3/8"	1/8"	*SEE NOTE
45491	45781	65391	1/4 A	16	1/4 - 1-1/8"	3/8"	1/16"	1/16
45451	45761	65381	13/16	10	13/16 - 1-3/8"	1/2"	1/32"	5/32

*NOTE: Parts # 45461, 45791, 65371 - 7/8", 1 - 1/8", 1 - 7/32", 1 - 1/4", 1 - 3/8" (1/2" and 3/4" conduit)

HANGING TUBES

00693	-----	-----	10	1	1/2"	1/4"	-----	1/16"
00694	-----	-----	12	1	3/8"	1/4"	-----	-----
00750	-----	-----	13	1	1-1/8"	1/2"	-----	-----

3 & 4 PC. SETS

Gold Oxide	Titanium Nitride	Titanium Carbon Nitride	
01911	01811	65431	1/8 - 1/2", 3/16 - 1/2" & 1/4 - 3/4" (#1, #4, #3)
01921	01821	65411	1/8 - 1/2", 3/16 - 1/2" & 3/16 - 7/8" (#1, #4, #8)
01931	01831	-----	1/8 - 1/2", 3/16 - 7/8" & 7/8 - 1-1/8" (#1, #8, #11)
01941	01841	65421	1/8 - 1/2", 3/16 - 1/2" & 1/4" - 1" (#1, #4, #2)
4pc. 01981	01871	65441	1/8 - 1/2", 1/4 - 3/4", 1/4 - 7/8", 7/8 - 1-1/8" (#1, #3, #7, #11)

TYPE 78-QR, 78-QRN QUICK RELEASE

78-QR Gold Oxide Part #	78-QRN Titanium Nitride Part #	Size	Hole Sizes	No. Range	Shank Size	Step Increments	Step Thickness
01401	68491	1	13	1/8 - 1/2"	1/4"	1/32"	1/8
01411	68534	2	8	1/4 - 1"	1/4"	1/16"	5/32
01404	68521	3	9	1/4 - 3/4"	1/4"	1/16"	5/32
01402	68501	4	6	3/16 - 1/2"	1/4"	1/16"	3/8
01412	68541	7	11	1/4 - 7/8"	1/4"	1/16"	1/16
01403	68511	8	12	3/16 - 7/8"	1/4"	1/16"	1/8
01409	68531	11	2	1/4 - 1-1/8"	1/4"	27/64"	9/64
*01414	68524	12	5	1/4 - 1-3/8"	1/4"	1/8"	*SEE NOTE
01413	68551	1/4 A	16	1/4 - 1-1/8"	1/4"	1/16"	1/16

*NOTE: Parts # 01414, 68524 - 7/8", 1 - 1/8", 1 - 7/32", 1 - 1/4", 1 - 3/8" (1/2" and 3/4" conduit)

3 PC. SETS

20751	68801	1/8 - 1/2", 3/16 - 1/2" & 1/4 - 3/4" (#1, #4, #3)
20761	68811	1/8 - 1/2", 3/16 - 1/2" & 3/16 - 7/8" (#1, #4, #8)
01461	68581	1/8 - 1/2", 3/16 - 7/8" & 7/8 - 1-1/8" (#1, #8, #11)

Specialty Tools

TWIN END & PILOT DRILLS, ALL PURPOSE HEAVY-DUTY

TYPE 140-G -SUPER PREMIUM

Twin End - Super Premium 135° Split Point

- Special Hi-Molybdenum tool steel, gold surface treated for maximum lubricity.
- 135° split point for fast penetration and accurate starting without a center punch.



TYPE 140-G FRACTIONAL

Part No.	Diameter Inches	Overall Length Inches	Flute Length Inches	Qty. per/pack
95090	3/32	1-3/4	9/16	12
95080	7/64	1-15/16	5/8	12
95980	1/8	1-15/16	5/8	12
95070	9/64	2	5/8	12
95060	5/32	2-1/8	5/8	12
95050	3/16	2-5/16	5/8	12
95040	7/32	2-9/16	3/4	12
95030	1/4	2-5/8	13/16	12

TYPE 140-G WIRE

Part No.	Diameter Wire Gauge	Overall Length Inches	Flute Length Inches	Qty. per/pack
95020	10	2-5/16	5/8	12
95010	11	2-5/16	5/8	12
95000	20	2-1/8	5/8	12
94990	30	2	5/8	12

TYPE 140 -HEAVY DUTY

Twin End - Heavy-Duty -135° Split Point

- This twin end drill has wide applications in drilling any thin sheet metal or wood.
- Automotive body shops will find twin end drills especially productive.
- Black Oxide finish.



TYPE 140 FRACTIONAL

Part No.	Diameter Inches	Overall Length Inches	Flute Length Inches	Qty. per/pack
28470	3/32	1-3/4	9/16	12
28480	7/64	1-15/16	5/8	12
28490	1/8	1-15/16	5/8	12
28500	9/64	2	5/8	12
28510	5/32	2-1/8	5/8	12
28530	3/16	2-5/16	5/8	12
28550	7/32	2-9/16	3/4	12
28570	1/4	2-5/8	13/16	12

TYPE 140 WIRE

Part No.	Diameter Wire Gauge	Overall Length Inches	Flute Length Inches	Qty. per/pack
27940	10	2-5/16	5/8	12
27950	11	2-5/16	5/8	12
28040	20	2-1/8	5/8	12
28140	30	2	5/8	12

PILOT DRILLS

Type 185

Pilot Drills For HSS Hole Saws



Part#	Size Inches	Description	Diameter Inches	Overall Length Inches	Qty. per/pack
95100	1/4" x 4	Universal pilot with two whistle notch flats. Fits most hole saws needing 4" length - Bright finish	1/4"	4"	12
95101	1/4" x 3"	Fits most arbors with one set screw One flat on shank . Bright finish. Lennox, Starrett, Morse, Milwaukee & more.	1/4"	3	12
95102	1/4" x 4"L	Three long flats on shank allow for set screw and eliminate slippage. Fits through the arbor drive. Surface treated. (Replaces Lennox and others).	1/4"	4	12
95103	1/4" x 3"L	Same as 95101 except surface treated. (Replaces Lennox and others).	1/4"	3	12
95104	1/4" x 4-1/4"L	Three long flats on shank allow for set screw and eliminate slippage. Fits through the arbor drive. Black Surface treated. (Replaces Lennox L-series).	1/4"	4-1/4"	12

ALL PURPOSE HEAVY-DUTY

Type 214

- Carbide tipped, hardened steel bodies (3/8" diameter and smaller), 6% cobalt carbide grade, lifetime tip warranty against braze failure, and slow spiral.
- Black surface finish with bronze colored tip.
- Recommended for both impact and rotary use.
- Especially suited for drilling 2500-5000 psi concrete.



Part #	Diameter Inches	Overall Length Inches	Qty. per/pack
94600	1/8	3	12
94610	3/16	4	12
94620	3/16	6	12
94640	1/4	4	12
94650	1/4	6	12
94670	5/16x1/4	4	6
94680	5/16x1/4	6	6
94700	3/8x1/4	4	6
94710	3/8x1/4	6	6
94720	3/8x1/4	13	1

Part #	Diameter Inches	Overall Length Inches	Qty. per/pack
94730	3/8x3/8	6	6
94750	7/16x1/4	4	6
94760	7/16x1/4	6	6
94810	1/2x1/4	6	6
94830	1/2x3/8	6	6
94860	9/16x3/8	13	1
94890	5/8x3/8	6	1
94910	5/8x1/2	6	1
94920	5/8x1/2	13	1

ACRYLIC, HARD STEEL, SOLID CARBON DRILL, SHEETERS DRILLS & CUTTING TOOL LUBRICANT

Type 183-AG

Acrylic Drills with Chipfree™ Point Magnum Super Premium

- Super **CHIPFREE™** point is precision ground at a 60° angle for gradual penetration to avoid cracking and chipping of the acrylic material.
- Special 0° rake angle on cutting edge eliminates “grabbing” when drill breaks through plastic, acrylic, or laminate surfaces.
- All sizes over 1/4" have 1/4" shanks.



Part No.	Diameter Inches	Overall Length Inches	Flute Length Inches	Qty. per/pack
32260	3/32	2-1/4"	1-1/4"	12
31500	1/8	2-5/8"	1-5/8"	12
32200	9/64	2-7/8"	1-3/4"	12
31510	5/32	3"	2"	12
31520	3/16	3-3/8"	2-5/16"	12
32210	13/64	3-21/32"	2-7/16"	12
32220	7/32	3-13/16"	2-1/2"	12
31530	1/4	3-15/16"	2-3/4"	12
32240	9/32	3-9/16"	1-31/32	12
32230	19/64	3-23/32"	2"	12
31540	5/16	3-13/16"	2-1/8	6
32290	11/32	4-1/32"	2-11/32	6
31550	3/8	4-1/4"	2-5/16	6
32250	25/64	4-11/32"	2-9/16"	6
32460	13/32	4-15/32"	2-11/16	6
31560	7/16	4-11/16"	2-7/8	6
32470	15/32	4-7/8"	3-1/16	6
31570	1/2	5"	3-3/16	6

Type 224

Sheeters Drill - Black Surface Treated

Heavy-duty 135° split point high-speed steel drill is excellent for drilling sheet metal and corrugated construction panels.



Part #	Diameter Wire Gauge	Overall Length Inches	Flute Length Inches	Qty. per/pack
27010	1	3"	1-5/16	12
27030	1	4-1/2"	1-5/16	12
27040	1	6"	1-5/16	12

CUTTING TOOL LUBRICANT

Type 11-AG Ultra S/P™ Super Premium High Viscosity

- Super concentrated no run formula.
- Clings to vertical surfaces for continual lubrication.
- Virtually smoke free in even the most heat prone applications.
- Contains no ozone depleting substances.

This fluid will extend tool life and yield a super machined finish.



Part #	Size MM	Bottles Per Case	Weight Per Case
96050	12 - 4 OZ.	12	4.4 Lbs./2 Kgs.
96060	48 - 4 OZ.	48	18 Lbs./8.2 Kgs.
96070	12 - 16 OZ.	12	15 Lbs./6.8 Kgs.

Part No. 96071 is a self selling display with an attractive attention getting decal applied to the inside of the display flap. Dispose of display when empty.

Type 602-C Solid Carbide

Solid Carbide Drills, Straight Flute

- Excellent for removing broken screw extractors, tap and drills bits. For use in extremely hard and difficult to machine materials. Produces accurate holes.



Type 602-C

Designed for drilling holes in 48-65 RC hardened steel, stainless steels, and high temperature alloys.

Part No.	Diameter Inches	Shank Diameter Inches	Overall Length Inches	Qty. per/pack
36173	1/16	1/16	1-5/8	1
36193	3/32	3/32	1-3/4	1
36213	1/8	1/8	1-7/8	1
36233	5/32	5/32	2-1/16	1
36253	3/16	3/16	2-3/16	1
36273	7/32	7/32	2-3/8	1
36293	1/4	1/4	2-1/2	1
36313	9/32	9/32	2-11/16	1
36333	5/16	1/4	2-13/16	1
36353	11/32	11/32	3	1
36373	3/8	3/8	3-1/8	1
36393	13/32	13/32	3-5/16	1
36413	7/16	7/16	3-7/16	1
36433	15/32	15/32	3-5/8	1
36453	1/2	1/2	3-3/4	1
36473	5/8	5/8	4	1
36483	3/4	3/4	4	1

Type 602

Carbide Tipped Hard Steel Drills Carbide Tipped, Straight Flute

- Used for drilling broken studs, springs, bolts, die sections, broken easy outs, extra tough or exotic metals, and brake drums.



Type 602

These drills are made for use in drilling hardened steel in the range of 48 to 65 Rockwell C.

Part No.	Diameter Inches	Shank Diameter Inches	Overall Length Inches	Qty. per/pack
32300	1/8	1/8	2-3/4	1
32310	5/32	5/32	3	1
32320	11/64	11/64	3	1
32330	3/16	3/16	3	1
32340	7/32	7/32	4	1
32350	1/4	1/4	4	1
32360	1/4	1/4	6	1
32370	9/32	9/32	4	1
32380	5/16	1/4	4	1
32390	5/16	5/16	6	1
32400	3/8	1/4	4	1
32410	3/8	3/8	6	1
32420	7/16	3/8	6	1
32430	1/2	1/2	6	1
32440	9/16	1/2	6	1
32450	5/8	1/2	6	1

CARBIDE TIPPED HOLECUTTERS

Type CHC-AG Carbide Tipped Holecutters CUTS UP TO 3/16"

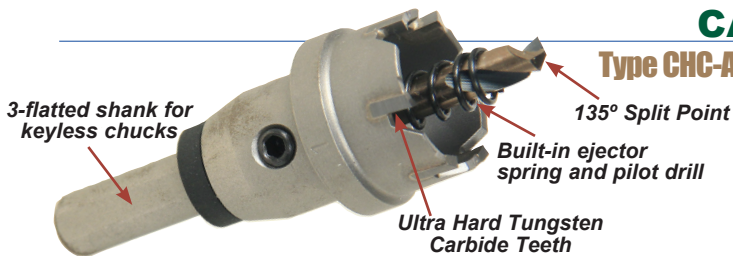

Part#	Diameter Inches	Shank Diameter	Qty. per/pack
62000	9/16	3/8	1
62010	5/8	3/8	1
62020	11/16	3/8	1
62030	3/4	3/8	1
62040	13/16	3/8	1
62050	7/8	3/8	1
62060	15/16	3/8	1
62070	1"	3/8	1
62080	1-1/16	3/8	1
62090	1-1/8	3/8	1
62100	1-3/16	3/8	1
62110	1-1/4	3/8	1
62120	1-5/16	3/8	1
62130	1-3/8	3/8	1

Part#	Diameter Inches	Shank Diameter	Qty. per/pack
62140	1-7/16	3/8	1
62150	1-1/2	3/8	1
62160	1-9/16	3/8	1
62170	1-5/8	3/8	1
62180	1-11/16	3/8	1
62190	1-3/4	3/8	1
62200	1-13/16	3/8	1
62210	1-7/8	3/8	1
62220	1-15/16	3/8	1
62230	2"	3/8	1
62240	2-1/16	3/8	1
62250	2-1/8	3/8	1
62260	2-3/16	3/8	1
62270	2-1/4	3/8	1

Part#	Diameter Inches	Shank Diameter	Qty. per/pack
62280	2-5/16	3/8"	1
62290	2-3/8	3/8"	1
62300	2-7/16	3/8"	1
62310	2-1/2	3/8"	1
62320	2-9/16	3/8"	1
62330	2-5/8	3/8"	1
62340	2-11/16	1/2"	1
62350	2-3/4	1/2"	1
62360	2-13/16	1/2"	1
62370	2-7/8	1/2"	1
62380	2-15/16	1/2"	1
62390	3"	1/2"	1
62400	3-1/4	1/2"	1
62410	3-1/2	1/2"	1
62420	3-3/4	1/2"	1
62430	4"	1/2"	1
62440	4-1/4	1/2"	1
62450	4-1/2	1/2"	1
62460	4-3/4	1/2"	1
62470	5"	1/2"	1
62480	PILOT DRILL		1
62490	SCREW		1
62500	SPRING		1

Type CHD-AG

Deephole Carbide Tipped Holecutters CUTS UP TO 1"

- Produces overlapping and interrupted holes easily
- Cuts 3 times faster than bi-metal hole saws.

Part#	Diameter Inches	Shank Diameter	Qty. per/pack
63990	9/16	3/8"	1
64000	5/8	3/8"	1
64010	11/16	3/8"	1
64020	3/4	3/8"	1
64030	13/16	3/8"	1
64040	7/8	3/8"	1
64050	15/16	3/8"	1
64060	1"	3/8"	1
64070	1-1/16	3/8"	1
64080	1-1/8	3/8"	1
64090	1-3/16	3/8"	1
64100	1-1/4	3/8"	1
64110	1-5/16	3/8"	1
64120	1-3/8	3/8"	1
64130	1-7/16	3/8"	1
64140	1-1/2	3/8"	1
64150	1-9/16	3/8"	1
64160	1-5/8	3/8"	1

Part#	Diameter Inches	Shank Diameter	Qty. per/pack
64170	1-11/16	3/8"	1
64180	1-3/4	3/8"	1
64190	1-13/16	3/8"	1
64200	1-7/8	3/8"	1
64210	1-15/16	3/8"	1
64220	2"	3/8"	1
64240	2-1/16	3/8"	1
64250	2-1/8	3/8"	1
64260	2-3/16	3/8"	1
64270	2-1/4	3/8"	1
64280	2-5/16	3/8"	1
64290	2-3/8	3/8"	1
64330	2-7/16	3/8"	1
64340	2-1/2	3/8"	1
64350	2-9/16	3/8"	1
64360	2-5/8	3/8"	1
64370	2-11/16	1/2"	1
64380	2-3/4	1/2"	1

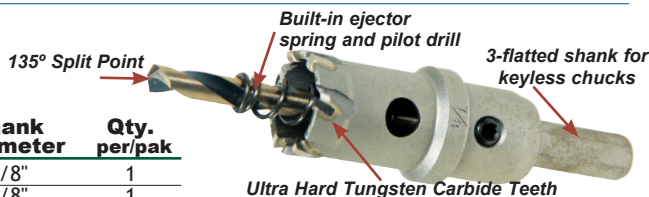

Part#	Diameter Inches	Shank Diameter	Qty. per/pack
64390	2-13/16	1/2"	1
64400	2-7/8	1/2"	1
64410	2-15/16	1/2"	1
64420	3"	1/2"	1
64430	3-1/4	1/2"	1
64440	3-1/2	1/2"	1
64450	3-3/4	1/2"	1
64460	4"	1/2"	1
64470	4-1/4	1/2"	1
64480	4-1/2	1/2"	1
64490	4-3/4	1/2"	1
64231	PILOT DRILL		1
62490	SCREW		1
62530	SPRING		1

Type CHC-QR Carbide Tipped Holecutters

1/4" Hex Shank Quick Release

- 3-flatted shank for keyless chucks.
- Produces overlapping and interrupted holes easily
- Cuts 3 times faster than bi-metal hole saws.



Part#	Diameter Inches	Shank Diameter	Qty. per/pack	Part#	Diameter Inches	Shank Diameter	Qty. per/pack
83470	5/8	1/4	1	83560	1-3/16	1/4	1
83480	11/16	1/4	1	83580	1-1/4	1/4	1
83490	3/4	1/4	1	83590	1-5/16	1/4	1
83500	13/16	1/4	1	83600	1-3/8	1/4	1
83510	7/8	1/4	1	83950	PILOT DRILL		1
83520	15/16	1/4	1	83960	SCREW		1
83530	1"	1/4	1	83970	SPRING		1
83540	1-1/16"	1/4	1				
83550	1-1/8"	1/4	1				

Type EXT - Extension

Carbide Tipped Holecutter - Extension

Includes: "Allen Wrench" (For CHC-UB & CHD-UB Holecutter only)



Part#	Bore/Shank	Diameter	Overall Length	Ext Length	Qty. per/pack
62710	3/8"	7/8"	6-1/4"	5 inches	1
62720	1/2"	7/8"	6-1/4"	5 inches	1

Type CHC-18

Carbide Tipped Holecutter - Hanging Display

Contents	Size	# of Ea.
CHC-AG	13/16", 7/8", 15/16", 1", 1-1/16"	1
Depth of cut	3/16"	1-1/8", 1-3/16", 1-1/4", 1-3/8"
CHD-AG	13/16", 7/8", 15/16", 1", 1-1/16"	1
Depth of cut	1"	1-1/8", 1-3/16", 1-1/4", 1-3/8"
Display Rack	16" width x 27" height	1
	(Display Rack Only Part #14120)	

Type CHC-3QR Quick Release SETS - 3 pc.

83990	7/8", 1-1/8" & 1-3/8"
-------	-----------------------



COUNTERSINKS & TECHNICAL DIAGRAMS & COMBINED DRILLS



Type 82-AG - Piloted Type 82-AG - Pilotless Type 90-AG - Deburring

Type 82-AG Chatter proof™ - Countersinks
Type 90-AG Chatter proof™ - Deburring Tools

Special Hi-Molybdenum tool steel, gold surface treated for maximum lubricity.

These high performance, flute-less tools are:

- Free cutting - for ease of use. • Designed for fast stock removal.
- Chatter proof - for a micro smooth finish.
- Available in a wide selection of styles.
- Recommended for smooth finishes on metal, plastic and wood applications.
- Made in the U.S.A.

TYPE 82-AG 82° PILOTED COUNTERSINK

Part No.	Size	Style	Screw Size	Shank Diameter			Overall Length				No. per/pack
				A	B	C	D	E	F		
67010	CS1/4	1	1/4"	1/4"	3/8"	2"	33/64"	1"	5/32"	1	
67020	CS1/4A	1	1/4"	17/64"	3/8"	2"	33/64"	1"	5/32"	1	
67030	CS5/16	1	5/16"	5/16"	3/8"	2-3/16"	41/64"	1-3/16"	5/32"	1	
67040	CS5/16A	1	5/16"	21/64"	3/8"	2-3/16"	41/64"	1-3/16"	5/32"	1	
67050	CS3/8	1	3/8"	3/8"	1/2"	2-5/8"	49/64"	1-3/8"	5/32"	1	
67060	CS3/8A	1	3/8"	25/64"	1/2"	2-5/8"	49/64"	1-3/8"	5/32"	1	
67070	CS7/16	1	7/16"	7/16"	1/2"	2-3/4"	53/64"	1-1/2"	7/32"	1	
67080	CS7/16A	1	7/16"	29/64"	1/2"	2-3/4"	53/64"	1-1/2"	7/32"	1	
67090	CS1/2	1	1/2"	1/2"	1/2"	2-13/16"	15/16"	1-9/16"	1/4"	1	
67100	CS1/2A	1	1/2"	33/64"	1/2"	2-13/16"	15/16"	1-9/16"	1/4"	1	

See left for technical diagram.

TYPE 82-AG 82° PILOT LESS COUNTERSINK

Part No.	Size	Style	Diameter of Cut		Screw Size	Shank Diameter B	Overall Length			No. per/pack
			Min	Max			C	D	E	
67110	CS073	3	5/64"	15/64"	---	1/4"	1-3/4"	---	---	1
67120	CS3/16	2	3/16"	17/32"	---	1/4"	1-15/16"	9/16"	1"	1
67130	CS307	2	5/16"	25/32"	---	1/2"	2-5/8"	13/16"	1-3/8"	1
67140	CS307A	2	5/16"	25/32"	---	1/4"	2-1/16"	13/16"	1-1/4"	1
67150	CS431	2	7/16"	7/8"	---	1/2"	2-13/16"	1-1/8"	1-9/16"	1
67160	CS1/2B	2	1/2"	1-15/32"	---	1/2"	3-1/2"	1-1/2"	2-1/8"	1
67170	CS55	2	1/8"	17/64"	No. 4	1/4"	1-1/2"	17/64"	5/8"	1
67180	CS65	2	1/8"	19/64"	No. 6	1/4"	1-1/2"	19/64"	5/8"	1
67190	CS85	2	1/8"	11/32"	No. 8	1/4"	1-5/8"	11/32"	3/4"	1
67200	CS105	2	9/64"	25/64"	No. 10	1/4"	1-5/8"	25/64"	3/4"	1

See left for technical diagram.

TYPE 90-AG 90° DEBURRING TOOLS

Part No.	Size	Style	Diameter of Cut		Shank Diameter B	Overall Length			No. per/pack
			Min	Max		C	D	E	
67210	DB1/64	3	1/64"	11/64"	3/16"	1-1/2"	---	---	1
67220	DB1/16	3	1/16"	11/64"	3/16"	1-1/2"	---	---	1
67230	DB1/8	3	1/8"	15/64"	1/4"	1-3/4"	---	---	1
67240	DB5/32	2	5/32"	13/32"	1/4"	1-11/16"	7/16"	13/16"	1
67250	DB3/16	2	3/16"	17/32"	1/4"	1-7/8"	9/16"	1"	1
67260	DB5/16	2	5/16"	25/32"	1/2"	2-19/32"	13/16"	1-3/8"	1
67270	DB5/16C	2	5/16"	25/32"	1/4"	2-1/32"	13/16"	1-5/32"	1
67280	DB9/16	2	9/16"	1-3/32"	1/2"	2-13/16"	1-1/8"	1-9/16"	1
67290	DB1/2	2	1/2"	1-15/32"	1/2"	3-1/2"	1-1/2"	2-1/8"	1

See left for technical diagram.

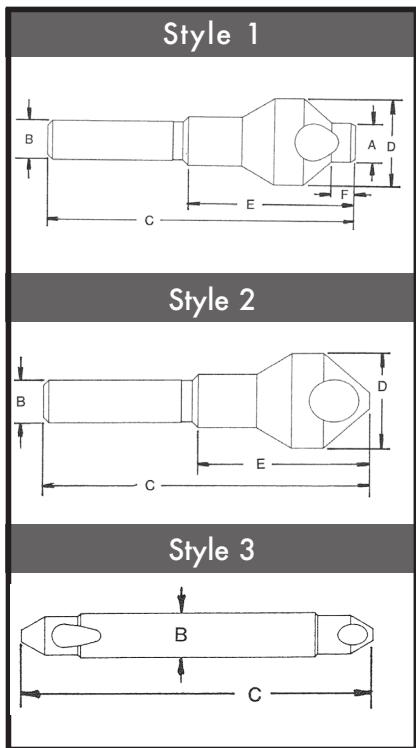

Specialty Tools

COMBINED DRILLS, COUNTERSINK SETS & 6-FLUTE COUNTERSINK TOOL

TYPE 82-AG & TYPE 90-AG SETS

Part#	Description of Sizes
SP-4CS 10440	82-AG C/S sizes: CS5S, CS6S, CS8S, CS10S
SP-4ACS 10442	82-AG C/S sizes: CS6S, CS8S, CS10S, CS3/16
SP-6DB 10450	90-AG D/B sizes: DB1/16, DB1/8, DB5/32, DB3/16, DB5/16 & DB9/16
SP-9CS 10443	82-AG C/S sizes: CS5S, CS6S, CS8S, CS10S, CS1/4, CS5/16, CS3/8, CS7/16, & CS1/2



COMBINED DRILLS & COUNTERSINK

Type 296 -Plain

Drill ends are of equal diameter. The included angle is 60°.



TYPE 296 PLAIN COUNTERSINKS

Part#	Size	Dia. of Body Inches	Dia. & Length of drills	Overall Length Inches	No. per/Pack
26760	00	1/8	.025x.030	1-7/32	5
26770	0	1/8	1/32x.038	1-7/32	5
26780	1	1/8	3/64x3/64	1-1/4	5
26790	2	3/16	5/64x5/64	1-7/8	5
26800	3	1/4	7/64x7/64	2	5
26810	4	5/16	1/8x1/8	2-1/8	5
26820	5	7/16	3/16x3/16	2-3/4	5
26830	6	1/2	7/32x7/32	3	5
26840	7	5/8	1/4x1/4	3-1/4	1
26850	8	3/4	5/16x5/16	3-1/2	1

COMBINED DRILLS AND COUNTERSINK - SET

26861 5pc. Bright Finish Sizes: 1, 2, 3, 4 and 5



6-FLUTE 82° CHATTER-LESS HSS COUNTERSINK

Type 83-AG

- Chatter-less 6-flute design reduces vibration
- Multiple cutting edges extend tool life.
- 82° Countersink produce the ideal profile for the majority of flat head fasteners.
- 3-Flat on shank
- Made in the USA.



Type 83-AG

4pc. Type 83-AG



TYPE 83-AG HSS 82° COUNTERSINK

Part#	Size	Shank Size	# per/Pack
67700	1/4"	1/4"	1
67710	5/16"	1/4"	1
67720	3/8"	1/4"	1
67730	1/2"	3/8"	1
67740	5/8"	3/8"	1
67750	3/4"	1/2"	1
67760	7/8"	1/2"	1
67770	1"	1/2"	1
67780	1-1/4"	1/2"	1
67790	1-1/2"	3/4"	1

4PC. HSS 82° COUNTERSINK SET

Part#	Sizes	Shank Sizes	# per/Pack
67800	1/4", 5/16", 3/8", *1/2"	1/4", *3/8"	1

COMBINED DRILLS & COUNTERSINK

Type 296-XL - Long Length 60°

- 60° degree countersink angle fits all standard centers.
- Used for centering work ends, where the work piece is to be revolved on machine centers.
- Made in the USA.



TYPE 296-XL COMBINED DRILLS & COUNTERSINK

Part#	Size	Body Diameter	Drill Diameter	No. per/Pack
08603	1x3	1/8"	3/64"	1
08613	1x4	1/8"	3/64"	1
08623	1x5	1/8"	3/64"	1
08633	1x6	1/8"	3/64"	1
08643	2x3	3/16"	5/64"	1
08653	2x4	3/16"	5/64"	1
08663	2x5	3/16"	5/64"	1
08673	2x6	3/16"	5/64"	1
08683	3x3	1/4"	7/64"	1
08693	3x4	1/4"	7/64"	1
08703	3x5	1/4"	7/64"	1
08713	3x6	1/4"	7/64"	1
08723	4x4	5/16"	1/8"	1
08733	4x5	5/16"	1/8"	1
08743	4x6	5/16"	1/8"	1
08753	4-1/2x4	3/8"	9/64"	1
08763	4-1/2x5	3/8"	9/64"	1
08773	4-1/2x6	3/8"	9/64"	1
08783	5x4	7/16"	3/16"	1
08793	5x5	7/16"	3/16"	1
08803	5x6	7/16"	3/16"	1
08813	6x5	1/2"	7/32"	1
08823	6x6	1/2"	7/32"	1
08833	7x6	5/8"	1/4"	1
08843	8x6	3/4"	5/16"	1

SUPER COBALT - WELD OUT™ CARBIDE SPOT WELD DRILLS

Carbide ALTiN

Specialty Tools - Spotweld Drills

Type 186

Weldout™ Spot weld
Super Cobalt HSS
Gold Finish - Heavy-Duty Spur Point

- This rugged high performance drill is designed to effectively cut auto body panel spot welds.



High red hardness of cobalt steel permits speeds 30% greater than HSS drill.

Part No.	Diameter MM	Approx. Spotweld Size, Inches	OAL Inches	Flat Length Inches	Qty. per/pack
66420	6.5mm	1/4	1.56	.44	5
37240	6.5mm	1/4	1.49	.44	5
37520	6.5mm	1/4	1.75	none	5
37660	6.5mm TE*	1/4	3.62	none	5
66430	8.0mm	5/16	1.56	.44	5
37250	8.0mm	5/16	1.49	.44	5
37510	8.0mm	5/16	1.69	.75	5
37470	8.0mm	5/16	1.75	none	5
37670	8.0mm TE*	5/16	3.62	none	5
37530	10.0mm	3/8	1.75	none	5
37680	10.0mm TE*	3/8	3.62	none	5

The spur point on the **Type 186** is designed to cut through the weld on one panel while leaving the second panel free of holes.

Type 187

Weldout™ Spotweld Super Cobalt HSS
Gold Finish - Heavy-Duty Spur Point

- This rugged high performance drill is designed to effectively cut auto body panel spot welds.



Our Super Cobalt HSS contains 8% cobalt.

Part No.	Diameter MM	Approx. Spotweld Size, Inches	OAL Inches	Flat Length Inches	Qty. per/pack
66180	8.0	5/16"	2.25	none	5
66190	10.00	3/8"	2.25	none	5
37671	8.0 TE*	5/16"	3.62	none	5
37681	10 TE	3/8"	3.62	none	5

The modified point on the **Type 187** drill is chip resistant with slightly greater penetration into the second panel.

Weldout™ Spot weld Drills Sets

- Cobalt steel is substantially more abrasion resistant, resulting in long wear cutting edges.



Heavy-Duty Spur Point

Designed for use in high strength high alloy steel commonly used in the automobile industry.

TYPE 186 WO-6 SET

Part No.	Description of Sizes
35010	6.5mm, 8.0mm & 10.0mm Single-end drills with 1.75" length
	6.5mm, 8.0mm & 10.0mm Twin end drills with 3.62" length

TYPE 187 WO-4 SET

Part No.	Description of Sizes
35050	8.0mm & 10mm Single-end 8.0mm & 10mm Twin-end In Type 187 Length

Type 187-B

Carbide Aluminium Titanium Nitride
Spot weld Drills

- Designed to cut spot welds from Boron Steel
- Use in high temperature operations and difficult to machine materials.
- ALTiN coating improves lubricity, eliminating lubrication requirements.

1-3/4" to 2-1/4" OAL - Recommended (900 RPM - 1,000 RPM)



Carbide ALTiN offers higher temperature resistance.

3" OAL with Round - Recommended (900 RPM - 1,000 RPM)



Carbide ALTiN typically last 3 to 10 times longer than uncoated tools. Created for abrasive and high temperature applications (> 800°C).

TYPE 187-B

Part No.	Diameter MM	Approx Spot weld Size, Inches	OAL Inches	Flat Length Inches	Qty. per/pack
85910	6.7	17/64"	3"	NONE	1
85890	8.0	5/16	2"	NONE	1
85900	10.0	3/8	2-1/4"	NONE	1

TYPE 187-B WITH FLAT

Part No.	Diameter MM	Approx Spotweld Size, Inches	OAL Inches	Flat Length Inches	Qty. per/pack
85920	6.7	17/64"	1-3/4"	.750	1
85880	8.0	5/16	1-3/4"	.750	1

Type 187-DN

Titanium Nitride Weldout™ Spot weld Drills
Cobalt HSS - Heavy-Duty Spur Point

- Titanium nitride coated M42 cobalt steel spot weld drills are designed for use in high strength high alloy steel commonly used in the automobile industry.
- Titanium nitride coating doubles the tool life, gives additional lubricity and protects the cutting edges of the drill in tough removal applications.
- Titanium nitride drills require a slower speed (490 RPM) when drilling difficult materials.

Part No.	Diameter MM	Approx Spotweld Size, Inches	AOL Inches	Flat Length Inches	Qty. per/pack
73450	8.0	5/16"	2.25	none	1
73460	10.00	3/8"	2.25	none	1
73470	8.0 TE*	5/16"	3.62	none	1
73480	10 TE	3/8"	3.62	none	1

Cutting Tool Sets Index

Jobber Length NAS 907B Heavy Duty 135° Split point

- Type 190-CN CN-TECH™ CRYO/NITRIDE . 112
- Type 190-AG Heavy Duty Magnum . . . 112
- Type 170-AG Metric. 112
- *Type 128-AG 3/8" Shank 112
- Type 190 Black Oxide 114 - 115
- *Type 198 V-Line Black Oxide . . . 116
- Type 190-AN Titanium Nitride. . . 114 - 115
- Type 190-ACN Titanium Nitride . . 114 - 115
- Type 190-ALN Titanium Nitride . . 114 - 115
- *Type 190-GF Gold Strike™ 3-Flats. . 116
- *Type 190-GFR Gold Strike™ 3/8" RS 116
- * Not NAS907B

Mechanic Length 135° Split point

- Type 175-AG 113
- Type 178-AG Magnum 3/8" Shank . . 113
- Type QR-AG 1/4" Hex Shank. 113
- Type 191 V-line Black Oxide CAD-HD . . . 124

VORTEX-POINT Mechanic Length 135° SP

- Type 175-VT Black & Gold 113
- Type VT&R-8P Vortex-Point & Fast Spiral Reamers. 126

Jobber Length Hi-Helix 135° SP

- Type 190-SS Black & Gold 114

Jobber Length

General Purpose 118° point

- Type 100 Bright Finish. 119 - 121
- Type 128 3/8" RS Bright Finish . . 119 - 121
- Type 100-BN Titanium Nitride . . . 119 - 121
- Type 115 Black Oxide 119 - 121
- Type 170 Metric - Black Oxide. . . . 121
- Type 118 V-Line Black Oxide . . . 119 - 120

Jobber Length Parabolic 135° SP

- Type 190-P Black Oxide. 123
- Type 190-PT Titanium Nitride 123

Screw Machine Length NAS 907C

- Type 135-AG 122
- Type 135 Black Oxide 125
- Type 135-TN Titanium Nitride 125
- * Not NAS907C

Screw Machine Length 118° point

- Type 260 Bright Finish 124
- Type 260-BN Titanium Nitride. . . . 124

1/4" Shank 118°

- Type 120 122

Jobber Length Cobalt NAS 907J

- Type 150 117
- Type 150-N Titanium Nitride 117
- Type 150-M Metric - 135° SP . 117 - 118

Screw Machine Length M42 Cobalt

- Type 260-D 135° Split point 122

Silver & Deming 1/2" Shank

- Type 130-AG 135° Split point 126

- Type 130-AGX 118° Split Pt 3-Flats . 126

Type 130-CN CN-TECH™ CRYO/NITRIDE 126

- Type 130-D 135° Split point 126
- Type 130 118° point - Round Shank . 126
- Type 130-MRO 135° Split point 126

Step Drills

- Type 78-AG 129
- Type 78-AGN 129
- Type 78-ACN. 129
- Type 78-QR. 129
- Type 78-QRN 129

Acrylic Drills

- Type 183-AG Super ChipFree™ 124

Combination Drill & Tap

- Type 40-AG 128
- Type 40-QR. 128

Weldout™ Spotweld Drills

- Type 187 WO-4 127
- Type 186 WO-6 127

Left Hand Spiral

- Type 190-AL 127

Brad Point Drills

- Type 16-AG 127

Tap & Drill Sets

- B-18TD 128
- SP-18TD 128
- SP-18TDM. 128
- SP-18TDF 128
- SP-12TD 128
- SF-18TDC 128
- SF-18TDF 128
- SF-10TD 128

Bolt Extractor

- BR-8 Left Hand Drill Bolt Extractor. . . . 129
- BR-10 Left Hand Drill Bolt Extractor. . . . 129
- BR-8SQ Left Hand - Bolt Extractor 129
- SE-4N Bolt Extractor-Spiral Extractor . . . 129
- SE-5N Bolt Extractor-Spiral Extractor . . . 129
- SQE-4 Bolt Extractor-Spiral Extractor . . . 129

Chatter Proof™ Counter sink

- Type 82-AG Counter sink 129
- Type 90-AG Deburring Tools. 129

Hole Expansion Tools

- Type 50-AG Standard Flute 130
- Type 51-AG Fast Spiral 130

Hole Hog™

- Type 134-AG 130

Carbide Hole Cutters

- Type CHC-AG & CHD-AG 130
- 3pc. Carbide Holecutters CHC-AG . . 130



QUICK INDEX - Cutting Tool Sets

Cutting Tool Sets

JOBBER LENGTH, METRIC, 3/8" REDUCED SHANK



Type 190-CN CN-TECH™ CRYO/NITRIDE 135° Split point

- Nitride coating creates a case hardened surface that is resistant to rust, heat and extends tool life.
- Cryogenic treatment at -300° F increases toughness while reducing brittleness.
- Excellent for truck & trailer repair, and all MRO applications.

Type 190-AG NAS 907B 135° Split point Black & Gold Magnum Super Premium

- Manufactured to NAS 907B aerospace specification
- Body and clearance are gold surface treated for maximum lubricity.
- Recommended for use in work hardening grades of stainless steel & other hard metal drilling applications.

13 Pc.

Part No.	1/16-1/4 by 64ths	Qty of each
44110 SP-13	Black & Gold Super Premium 135° Split point	1
47492 CT-13	CN-TECH™ CRYO/NITRIDE	1

15 Pc.

Part No.	1/16-1/2 by 32nds	Qty of each
44120 SP-15	Black & Gold Super Premium 135° Split point	1
47472 CT-15	CN-TECH™ CRYO/NITRIDE	1

15 Pc. Ultra Dex™

Part No.	1/16-1/2 by 32nds	Qty of each
47482 CT-15P	CN-TECH™ CRYO/NITRIDE	1

21 Pc.

Part No.	1/16-3/8 by 64ths	Qty of each
44130 SP-21	Black & Gold Super Premium 135° Split point	1

26 Pc.

Part No.	A - Z	Qty of each
88660 SP-26	Black & Gold Super Premium 135° Split point	1

29 Pc.

Part No.	1/16-1/2 by 64ths	Qty of each
44150 SP-29	Black & Gold Super Premium 135° Split point	1
47452 CT-29	CN-TECH™ CRYO/NITRIDE	1

29 Pc. Ultra Dex™

Part No.	1/16-1/2 by 64ths	Qty of each
44170 SP-29P	Black & Gold Super Premium 135° Split point	1
47462 CT-29P	CN-TECH™ CRYO/NITRIDE	1

29 Pc. Blaze Orange Ultra Dex™

Part No.	1/16-1/2 by 64ths	Qty of each
44190 SP-29PON	Black & Gold Super Premium 135° Split point	1

60 Pc.

Part No.	# 1 - 60	Qty of each
88640 SP-60	Black & Gold Super Premium 135° Split point	1
47502 CT-60	CN-TECH™ CRYO/NITRIDE	1

114 Pc.

Part No.	1/16-1/2 by 64ths, #1-#60 & 1.0-13.0 by .05	Qty of ea.
93830 SP-114	Black & Gold Super Premium 135° Split point	1

115 Pc.

Part No.	1/16" - 1/2" x 64 ths + A-Z & 1-60	Qty of each
93840 SP-115	Black & Gold Super Premium 135° Split point	1
47512 CT-115	CN-TECH™ CRYO/NITRIDE	1

Type 128-AG

3/8" Reduced Shank, 135° Split point Black & Gold - Magnum Super Premium

- Recommended for use in work hardening grades of stainless steel & other hard metal drilling applications.

21 Pc.

Part No.	1/16-1/4 by 64ths, 9/32-1/2 by 32nds	Qty of each
92170 RSP-21	3/8" Reduced Shank	1

15 Pc.

Part No.	1/16-1/2 by 32nds	Qty of each
92110 RSP-15	3/8" Reduced Shank	1

29 Pc.

Part No.	1/16-1/2 by 64ths	Qty of each
92100 RSP-29	3/8" Reduced Shank	1

29 Pc. Black - Ultra Dex™

Part No.	1/16-1/2 by 64ths	Qty of each
92150 RSP-29P	3/8" Reduced Shank	1

29 Pc. Blaze Orange - Ultra Dex™

Part #	1/16 - 1/2 by 64ths	Qty of each
92152 RSP-29P0	3/8" Reduced Shank	1

Type 170-AG - Metric

NAS 907B Black & Gold Magnum Super Premium, 135° Split point

- Manufactured to NAS 907B aerospace specification
- Recommended for use in work hardening grades of stainless steel & other hard metal drilling applications.

11 Pc. - Metric

Part #	1.0mm - 6.0mm x .5mm	Qty of each
58650 SP-11M	Black & Gold Super Premium	1

13 Pc.- Metric

Part #	1.0mm - 7.0mm x .5mm	Qty of each
49042 SP-13M	Black & Gold Super Premium	1

19 Pc. - Metric

Part #	1.0mm - 10.0mm x .5mm	Qty of each
58920 SP-19M	Black & Gold Super Premium	1

25 Pc. - Metric

Part #	1.0mm - 13.0mm x .5mm	Qty of each
58660 SP-25M	Black & Gold Super Premium	1

41 Pc. - Metric

Part #	6.0mm - 10.0mm x .1mm	Qty of each
49043 SP-41M	Black & Gold Super Premium	1

118 Pc. - Metric

Part #	1.00 - 2.05mm by 0.05mm, 2.10 - 10.00 10mm by 0.1mm & 10.20, 10.50, 10.80, 11.00, 11.20, 11.50, 11.80, 12.00, 12.20, 12.50, 12.80 & 13.00)	Qty of each
60090 SP-118M	Black & Gold Super Premium	1

Cutting Tool Sets - Mechanic Length

QR 1/4" HEX SHANK & 3/8" REDUCED SHANK, VORTEX-POINT™

Type 175-AG

Mechanic Length - 135° Split point
Black & Gold Magnum Super Premium
3-Flats on Shank 3/16" and Larger

- Body and clearance are gold surface treated for maximum lubricity.
- Especially designed for hand held drills.
- Recommended for use in work hardening grades of stainless steel & other hard metal drilling applications.

13 Pc.

Part No.	Description of Sizes	Qty of each
66460 SPM-13	1/16 - 1/4" by 64ths	1

15 Pc.

Part No.	Description of Sizes	Qty of each
66470 SPM-15	1/16 - 1/2" by 32nds	1

21 Pc.

Part No.	Description of Sizes	Qty of each
57810 SPM-21	1/16 - 3/8" by 64ths	1

29 Pc.

Part No.	Description of Sizes	Qty of each
66480 SPM-29	1/16 - 1/2" by 64ths	1

29 Pc. Black- Ultra Dex

Part No.	Description of Sizes	Qty of each
66820 SPM-29P	1/16 - 1/2" by 64ths - w/ Ultra Dex	1

29 Pc. Blaze Orange- Ultra Dex

Part No.	Description of Sizes	Qty of each
67650 SPM-29PO	1/16 - 1/2" by 64ths	1

Type 178-AG

Mechanics Length -135° Split point
3/8" Reduced Shank with 3-Flats Shank
Black & Gold - Magnum Super Premium

21 Pc.

Part No.	Description of Sizes	Qty of each
92340 RSPM-21	1/16 - 1/4" by 64ths + 9/32-1/2 by 32nds (3/8" shank)	1

15 Pc.

Part No.	Description of Sizes	Qty of each
57910 RSPM-15	1/16 - 1/2" by 32nds (3/8" shank)	1

29 Pc.

Part No.	Description of Sizes	Qty of each
57920 RSPM-29	1/16 - 1/2" by 64ths (3/8" shank)	1

29 Pc. Black- Ultra Dex

Part No.	Description of Sizes	Qty of each
57950 RSPM-29P	1/16 - 1/2" by 64ths (3/8" shank) - w/ Ultra Dex	1

29 Pc. Blaze Orange- Ultra Dex

Part No.	Description of Sizes	Qty of each
58150 RSPM-29PO	1/16 - 1/2" by 64ths (3/8" shank) - w/ Ultra Dex	1

TYPE QR-AG 1/4" QUICK RELEASE

Quick Release Drills -
135° Split point Mechanics Length

- 135° Split point - Magnum Super Premium with 1/4" Hex Shanks
- Perfect for use with impactor tools.



TYPE QR12-AG HARD CASE SET

Part No.	Description of Sizes	Qty of each
34811	1/16, 3/32, 1/8, 5/32, 3/16, 7/32, 1/4, 5/16, 3/8, 7/16, 1/2", & Quick Release Adapter	1



TYPE QR16-AG SOFT POUCH SET

Part No.	Description of Sizes	Qty of each
34812	1/16, 3/32, 1/8, 5/32, 3/16, 7/32, 1/4, 9/32, 5/16, 11/32, 3/8, 13/32, 7/16, 15/32, 1/2", & Quick Release Adapter	1

TYPE QR-7B SOFT POUCH SET

Part No.	Description of Sizes	Qty of each
34804	1/8, 3/16, 1/4, 5/16, 3/8, 7/16, 1/2"	1

Sets QR-7B and QR-7A
do not include Quick Release Adapters



TYPE QR-7A SOFT POUCH SET

Part No.	Description of Sizes	Qty of each
34803	1/16, 3/32, 1/8, 5/32, 3/16, 7/32, 1/4"	1

VORTEX-POINT™

Type 175-VT

VORTEX-POINT™ Mechanics Length
135° Split point, 3-flats on Shank



- Unique tip geometry reduces heat generation & cutting tool wear increasing tool life.
- Recommended for Cast iron, Brass, Sheet metal, Plastic, Mild steel, Copper, Hardened steel.

13 Pc.

Part #	Description of Sizes	Qty of each
22863 VT-13	VORTEX-POINT™ 135° Split point	1

15 Pc.

Part #	Description of Sizes	Qty of each
22873 VT-15	VORTEX-POINT™ 135° Split point	1

21 Pc.

Part #	Description of Sizes	Qty of each
22883 VT-21	VORTEX-POINT™ 135° Split point	1

29 Pc.

Part #	Description of Sizes	Qty of each
22893 VT-29	VORTEX-POINT™ 135° Split point	1

29 Pc. Black - Ultra Dex

Part #	Description of Sizes	Qty of each
22903 VT-29P	VORTEX-POINT™ 135° Split point	1

29 Pc. Blaze Orange - Ultra Dex

Part #	Description of Sizes	Qty of each
22913 VT-29PO	VORTEX-POINT™ 135° Split point	1

Cutting Tool Sets

NAS 907B TITANIUM NITRIDE/TiCN/TiAlN & BLACK OXIDE, HI-HELIX FLUTES

Type 190-SS High Helix Flutes Jobber Length - 135° Split point

- High Helix Flute design allows for increased feed rates.
- Recommended for stainless steel, aluminum, brass and all other non-ferrous metals.

13 Pc.

Part No.	1/16 - 1/4" by 64ths	Qty of each
41591 SS-13	High Helix Flutes 135° Split point	1

15 Pc.

Part No.	1/16-1/2" by 32nds	Qty of each
41601 SS-15	High Helix Flutes 135° Split point	1

29 Pc.

Part No.	1/16-1/2" by 64ths	Qty of each
41611 SS-29	High Helix Flutes 135° Split point	1

29 Pc. Ultra Dex

Part No.	1/16-1/2" by 64ths	Qty of each
41621 SS-29P	High Helix Flutes 135° Split point	1

Type 190 Black Oxide NAS 907B - Heavy-Duty

- The 135° Split point makes this drill self-centering and requires less thrust in drilling harder metal than a general purpose drill.
- Recommended for medium hardness drilling applications.

Type 190-AN Titanium Nitride Coated NAS 907B - 135° Split point Heavy-Duty

- TiN coating provides a super hard surface with high lubricity.
- Greatly extends tool life in high wear or very abrasive applications.

Type 190-ACN Titanium Carbon Nitride (TiCN) NAS 907B - 135° Split point - HSS Heavy Duty

- TiCN is harder and has a lower coefficient of friction than Titanium nitride coating recommended were moderate temperatures are generated
- Heavy-duty construction for drilling in tougher materials
- Manufactured from premium high-speed steel
- 135° Split point is self-centering for reducing thrust and easier penetration
- Provides exceptional oxidation resistance and extreme hardness
- Manufactured to NAS 907B aerospace specification.

Type 190-ALN Titanium Aluminum Nitride (TiAlN) NAS 907B - 135° Split point - HSS Heavy Duty

- TiAlN provides extreme hardness and oxidation resistance, superior hot hardness when compared to other coatings.
- Heavy-duty construction for drilling in tougher materials
- Manufactured from premium high-speed steel
- 135° Split point is self-centering for reducing thrust and easier penetration
- Provides exceptional oxidation resistance and extreme hardness
- Manufactured to NAS 907B aerospace specification.



A-13

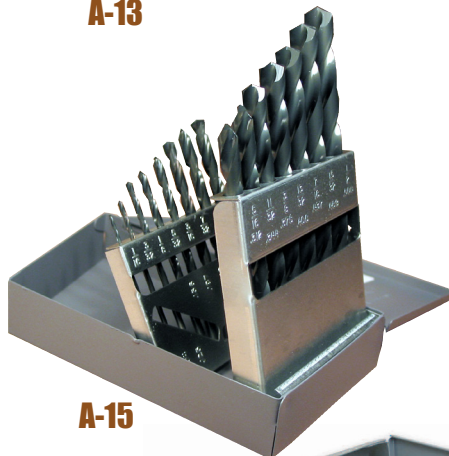

A-15



ACN-15

10 Pc.

Part #	1/16 - 5/32" by 64ths + 3/16, 7/32, 1/4	Qty of each
43330 A-10	Black Oxide - 135° Split point	1

11 Pc.

Part #	1/16 - 3/8" by 32nds	Qty of each
43320 A-11	Black Oxide - 135° Split point	1

13 Pc.

Part #	1/16 - 1/4" by 64ths	Qty of each
43340 A-13	Black Oxide - 135° Split point	1
88670 AN-13	Titanium Nitride - 135° Split point	1

15 Pc.

Part #	1/16 - 1/2" by 32nds	Qty of each
43350 A-15	Black Oxide 135° Split point	1
88680 AN-15	Titanium Nitride 135° Split point	1
81182 ACN-15	Titanium Carbon Nitride 135° SP	1
81150 ALN-15	Titanium Aluminum Nitride 135° SP	1

21 Pc.

Part #	1/16 - 3/8" by 64ths	Qty of each
43360 A-21	Black Oxide - 135° Split point	1
96740 AN-21	Titanium Nitride 135° Split point	1
88680 ACN-21	Titanium Carbon Nitride 135° Point	1
81160 ALN-21	Titanium Aluminum Nitride 135° SP	1

Cutting Tool Sets

NAS 907B TITANIUM NITRIDE / TiCN / TiAlN & BLACK OXIDE

Type 190 Heavy-Duty NAS 907B - Black Oxide

- The 135° Split point makes this drill self-centering and requires less thrust in drilling harder metal than a general purpose drill.
- It is recommended for medium hardness drilling applications.

Type 190-AN Titanium Nitride NAS 907B

135° Split point Heavy-Duty

- Titanium nitride provides a super hard surface with high lubricity.
- Greatly extends tool life in high wear or very abrasive applications.

Type 190-ACN Titanium Carbon Nitride (TiCN)

NAS 907B - 135° Split point Heavy-Duty

- Heavy-duty construction for drilling in tougher materials
- Manufactured from premium high-speed steel
- 135° Split point is self-centering for reducing thrust and easier penetration
- Provides exceptional oxidation resistance and extreme hardness
- Manufactured to **NAS 907B** aerospace specification.

Type 190-ALN Titanium Aluminum Nitride (TiAlN)

NAS 907B - 135° Split point Heavy-Duty

- Heavy-duty construction for drilling in tougher materials
- Manufactured from premium high-speed steel
- 135° Split point is self-centering for reducing thrust and easier penetration
- Provides exceptional oxidation resistance and extreme hardness
- Manufactured to **NAS 907B** aerospace specification.



AN-29



AN-29PON

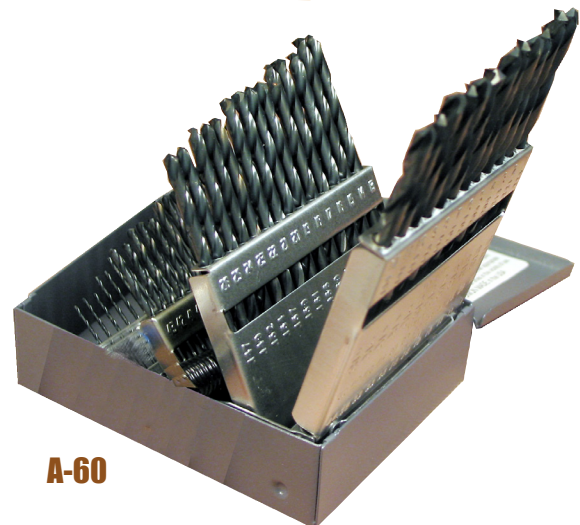

A-60

26 Pc.

Part #	A - Z	Qty of each
43370	A-26 Black Oxide - 135° Split point	1
81172	ACN-26 Titanium Carbon Nitride 135° Split point	1
81170	ALN-26 Titanium Aluminum Nitride 135° Split point	1

29 Pc.

Part #	1/16 - 1/2 by 64ths	Qty of each
43380	A-29 Black Oxide - 135° Split point	1
96690	AN-29 Titanium Nitride - 135° Split point	1
81162	ACN-29 Titanium Carbon Nitride 135° Split point	1
81180	ALN-29 Titanium Aluminum Nitride 135° Split point	1

29 Pc. Blaze Orange - Ultra Dex

Part No.	1/16-1/2 by 64ths	Qty of each
96770	AN-29PON Titanium Nitride - 135° Split point	1

60 Pc.

Part #	# 1 - 60	Qty of each
43390	A-60 Black Oxide - 135° Split point	1
96700	AN-60 Titanium Nitride - 135° Split point	1

115 Pc.

Part #	1/16 - 1/2 by 64ths + A - Z, #1 - 60	Qty of each
43420	A-115 Black Oxide - 135° Split point	1
95110	AN-115 Titanium Nitride - 135° Split point	1

Cutting Tool Sets - NAS 907B TiN / TiCN / TiAlN Coated & Black Oxide

Cutting Tool Sets

V-LINE, GOLD STRIKE & 3/8" REDUCED SHANK - JOBBER LENGTH



SA-21



GF-21RS



GF-29P

Type 198 V-Line Heavy-Duty Black Oxide

- American made value line drill.
- These 135° Split point drills are self centering and perform well in hard metals.
- This series is designed for the user whose applications are well served with out the need for the tighter tolerances of our standard **Type 190**.

Type 190-GF Gold-Strike™

3-Flats on Shank 3/16" and Larger

- Heavy-duty 135° Split point drills perform well in very demanding applications.
- Ideal for use with hand held drills with key-less chucks.

Type 190-GFR 3/8" Reduced Shank with Flats

- Heavy-duty gold finish 135° Split point drills perform well in very demanding applications.
- The flats on shank give positive chuck grip, ideal for use with hand held drills with key-less chucks.

13 Pc.

1/16 - 1/4" by 64ths

Part #		Qty of each
06072 SA-13	Black Oxide - 135° Split point	1
40611 GF-13	Gold Strike™ - 135° Split point	1

15 Pc.

1/16 - 1/2" by 32nds

Part #		Qty of each
06082 SA-15	Black Oxide - 135° Split point	1
40612 GF-15	Gold Strike™ - 135° Split point	1

21 Pc.

1/16 - 3/8" by 64ths

Part #		Qty of each
06092 SA-21	Black Oxide - 135° Split point	1
40613 GF-21	Gold Strike™ - 135° Split point (1/16 - 1/4" by 64ths & 9/32 - 1/2" by 32nds 3/8" reduced shank)	1
40631 GF-21RS	3/8"- Reduced Shank Gold Strike™	1

29 Pc.

1/16 - 1/2" by 64ths

Part #		Qty of each
06102 SA-29	Black Oxide - 135° Split point	1
40604 GF-29	Gold Strike™ - 135° Split point	1
40641 GF-29RS	3/8"- Reduced Shank Gold Strike™	1

29 Pc. -Ultra Dex

1/16 - 1/2" by 64ths

Part #		Qty of each
40614 GF-29P	Gold Strike™ - 135° Split point	1
40651 GF-29RSP	3/8"- Reduced Shank Gold Strike™	1

Cutting Tool Sets

COBALT HEAVY DUTY 135° SPLIT POINT - JOBBER LENGTH

Type 150 M42 Cobalt NAS 907J

- Manufactured from M42 HSS containing 8% cobalt which increases high red hardness.
- Cobalt drills require rigidly held positive feed drilling equipment.
- Manufactured to **NAS 907J** specifications.

Type 150-N M42 Cobalt NAS 907J - Titanium Nitride

- Manufactured from M42 HSS containing 8% cobalt which increases high red hardness.
- Cobalt drills require rigidly held positive feed drilling equipment.
- Titanium Nitride extends tool life.
- Manufactured to **NAS 907J** specifications.



DN-21

13 Pc.		
Part #	1/16 - 1/4" by 64ths	Qty of each
68320 D-13	M42 Cobalt NAS 907J	1
79890 DN-13	M42 Cobalt NAS 907J Titanium Nitride	1

15 Pc.		
Part #	1/16-1/2" by 32nds	Qty of each
68340 D-15	M42 Cobalt NAS 907J	1
79900 DN-15	M42 Cobalt NAS 907J Titanium Nitride	1

20 Pc.		
Part #	#60 - 80	Qty of each
68310 D-20	M42 Cobalt NAS 907J	1

21 Pc.		
Part #	1/16-3/8" by 64ths	Qty of each
68360 D-21	M42 Cobalt NAS 907J	1
79910 DN-21	M42 Cobalt NAS 907J Titanium Nitride	1

26 Pc.		
Part #	A - Z	Qty of each
68380 D-26	M42 Cobalt NAS 907J	1
79930 DN-26	M42 Cobalt NAS 907J Titanium Nitride	1

29 Pc.		
Part #	1/16-1/2" by 64ths	Qty of each
68400 D-29	M42 Cobalt NAS 907J	1
79920 DN-29	M42 Cobalt NAS 907J Titanium Nitride	1

29 Pc. -Ultra Dex		
Part #	1/16-1/2" by 64ths	Qty of each
68410 D-29P	M42 Cobalt NAS 907J	1

60 Pc.		
Part #	#1 - 60	Qty of each
68420 D-60	M42 Cobalt NAS 907J	1
79940 DN-60	M42 Cobalt NAS 907J Titanium Nitride	1

115 Pc.		
Part #	1/16-1/2" by 64ths + A - Z , #1 - 60	Qty of each
69280 D-115	M42 Cobalt NAS 907J	1
79950 DN-115	M42 Cobalt NAS 907J Titanium Nitride	1



D-29

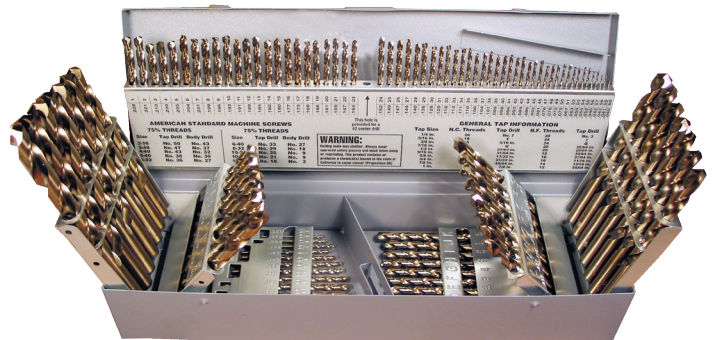

D-115

Cutting Tool Sets - Cobalt Heavy Duty 135° Split point

Cutting Tool Sets

COBALT HEAVY DUTY 135° SPLIT POINT - JOBBER LENGTH

Type 150-M **Metric** M42 Cobalt NAS 907J

- Manufactured from M42 HSS containing 8% cobalt which increases high red hardness.
- Cobalt drills require rigidly held positive feed drilling equipment.
- Manufactured to **NAS 907J** specifications.



D-13M

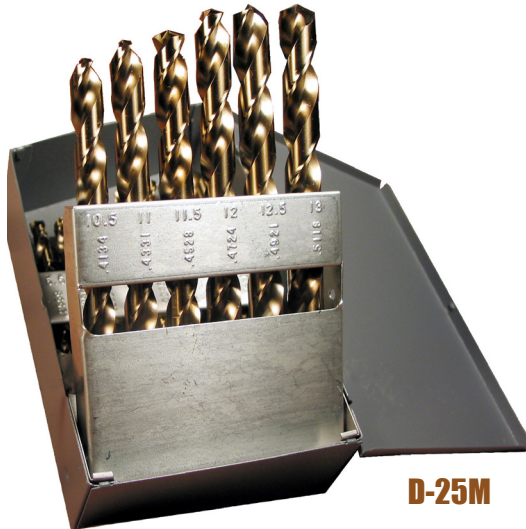

D-25M

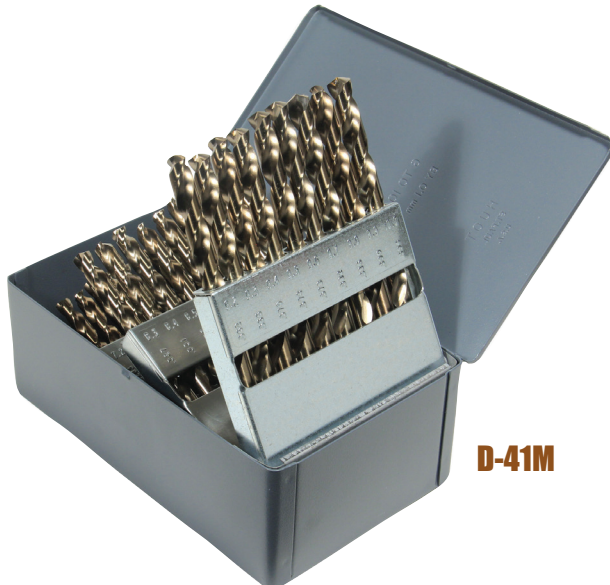

D-41M

11 Pc. - **Metric**

Part #	1.0mm - 6.0mm x .5mm	Qty of each
58670 D-11M	M42 Cobalt NAS 907J Gold Oxide	1

13 Pc. - **Metric**

Part #	1.0mm - 7.0mm x .5mm	Qty of each
49082 D-13M	M42 Cobalt NAS 907J Gold Oxide	1

19 Pc. - **Metric**

Part #	1.0mm - 10.0mm x .5mm	Qty of each
49081 D-19M	M42 Cobalt NAS 907J Gold Oxide	1

25 Pc. - **Metric**

Part #	1.0mm - 13.0mm x .5mm	Qty of each
58680 D-25M	M42 Cobalt NAS 907J Gold Oxide	1

41 Pc. - **Metric**

Part #	6.0mm - 10.0mm x .1mm	Qty of each
49083 D-41M	M42 Cobalt NAS 907J Gold Oxide	1

METRIC

Cutting Tool Sets - Cobalt Heavy Duty 135° Split point / TIN Coated

Cutting Tool Sets

GENERAL PURPOSE 118° POINT - JOBBER LENGTH

Type 115 Black Oxide

- Widely used in general purpose applications.
- Designed for a wide range of operating conditions and materials.

Type 100 Bright Finish

- Widely used in general purpose applications.
- Designed for a wide range of operating conditions and materials.

Type 100-BN Titanium Nitride

- Titanium Nitride extends cutting tool life.
- Widely used in general purpose applications.
- Designed for a wide range of operating conditions and materials.

Type 128 Bright Finish 3/8" Reduced Shank

- General purpose 118° point HSS drill is designed for use in portable air or electric drilling equipment with 3/8" chucks.

Type 118 V-Line Black Oxide

- American made value line drill
- These general purpose 118° point HSS drills are ideal for a wide variety of light tensile strength metal drilling applications.
- This series is designed for the user whose applications are well served without the need for the tighter tolerances of our **standard Type 115**.



B-13



B-21



BN-15

10 Pc.

1/16 - 5/32" by 64ths + 3/16", 7/32", 1/4"

Part #			Qty of each
42000	B-10	Black Oxide - 118° Point	1
43400	J-10	Bright Finish - 118° Point	1

11 Pc.

1/16 - 3/8" by 32nds

Part #			Qty of each
42010	B-11	Black Oxide - 118° Point	1
43410	J-11	Bright Finish - 118° Point	1

13 Pc.

1/16 - 1/4" by 64ths

Part #			Qty of each
42020	B-13	Black Oxide - 118° Point	1
43430	J-13	Bright Finish - 118° Point	1
48310	BN-13	Titanium Nitride - 118° Point	1
06073	SJ-13	V-Line Black Oxide - 118° Point	1

15 Pc.

1/16 - 1/2" by 32nds

Part #			Qty of each
42030	B-15	Black Oxide - 118° Point	1
43450	J-15	Bright Finish - 118° Point	1
48320	BN-15	Titanium Nitride - 118° Point	1
44540	R-15	3/8" Reduced Shank Bright Finish	1
06083	SJ-15	V-Line Black Oxide - 118° Point	1

Cutting Tool Sets

GENERAL PURPOSE 118° POINT - JOBBER LENGTH

Type 115 Black Oxide

- Widely used in general purpose applications.
- Designed for a wide range of operating conditions and materials.

Type 100 Bright Finish

- Widely used in general purpose applications.
- Designed for a wide range of operating conditions and materials.

Type 100-BN Titanium Nitride

- Titanium Nitride extends cutting tool life.
- Widely used in general purpose applications.
- Designed for a wide range of operating conditions and materials.

Type 128 Bright Finish, 3/8" Reduced Shank

- General purpose 118° point HSS drill is designed for use in portable air or electric drilling equipment with 3/8" chucks.

Type 118 V-Line, Black Oxide

- American made value line drill
- These general purpose 118° point HSS drills are ideal for a wide variety of light tensile strength metal drilling applications.
- This series is designed for the user whose applications are well served without the need for the tighter tolerances of our **standard Type 115**.



J-29



SJ-29

20 Pc.

61 - 80

Part #			Qty of each
42040	B-20	Black Oxide - 118° Point	1
43460	J-20	Bright Finish - 118° Point	1
48360	BN-20	Titanium Nitride - 118° Point	1

21 Pc.

1/16 - 3/8" by 64ths

Part #			Qty of each
42050	B-21	Black Oxide - 118° Point	1
43480	J-21	Bright Finish - 118° Point	1
06093	SJ-21	V-Line Black Oxide - 118° Point	1

26 Pc.

A - Z

Part #			Qty of each
42060	B-26	Black Oxide - 118° Point	1
48640	BN-26	Titanium Nitride - 118° Point	1
43500	J-26	Bright Finish - 118° Point	1

29 Pc.

1/16 - 1/2" by 64ths

Part #			Qty of each
42070	B-29	Black Oxide - 118° Point	1
43520	J-29	Bright Finish - 118° Point	1
48330	BN-29	Titanium Nitride - 118° Point	1
44530	R-29	3/8" Reduced Shank Bright Finish	1
06103	SJ-29	V-Line Black Oxide - 118° Point	1

60 Pc.

1 - 60

Part #			Qty of each
42080	B-60	Black Oxide - 118° Point	1
43540	J-60	Bright Finish - 118° Point	1
48340	BN-60	Titanium Nitride - 118° Point	1

Cutting Tool Sets

GENERAL PURPOSE 118° POINT - JOBBER LENGTH

Type 115 Black Oxide

- Widely used in general purpose applications.
- Designed for a wide range of operating conditions and materials.

Type 100 Bright Finish

- Widely used in general purpose applications.
- Designed for a wide range of operating conditions and materials.

Type 100-BN Titanium Nitride

- Titanium Nitride extends cutting tool life.
- Widely used in general purpose applications.
- Designed for a wide range of operating conditions and materials.

Type 128 Bright Finish 3/8" Reduced Shank

- General purpose 118° point HSS drill is designed for use in portable air or electric drilling equipment with 3/8" chucks.

NOTE: Surface treated flutes on sizes larger than 1/2".

Type 170 Black Oxide - Metric

- Widely used in general purpose applications.
- Designed for a wide range of operating conditions and materials.

Part #	80 Pc. #1 - 80	Qty of each
43300 B-80	Black Oxide - 118° Point	1

Part #	114 Pc. 1/16 - 1/2 by 64ths, #1 - 60, 1.0mm - 13.0mm by .5mm	Qty of each
43310 B-114	Black Oxide - 118° Point	1

Part #	115 Pc. 1/16 - 1/2 by 64ths + A - Z, #1-60	Qty of each
43440 B-115	Black Oxide - 118° Point	1
43550 J-115	Bright Finish - 118° Point	1
48350 BN-115	Titanium Nitride - 118° Point	1
44520 R-115	3/8" Reduced Shank Bright Finish	1

Part #	11 Pc. - Metric 1.0mm - 6.00 by .5mm	Qty of each
44050 M-11	Black Oxide - 118° Point	1

Part #	13 Pc.- Metric 1.0mm - 7.0mm x .5mm	Qty of each
44180 M-13	Black Oxide - 118° Point	1

Part #	25 Pc. - Metric 1.0mm - 13.0mm by .5mm	Qty of each
44060 M-25	Black Oxide - 118° Point	1



R-29

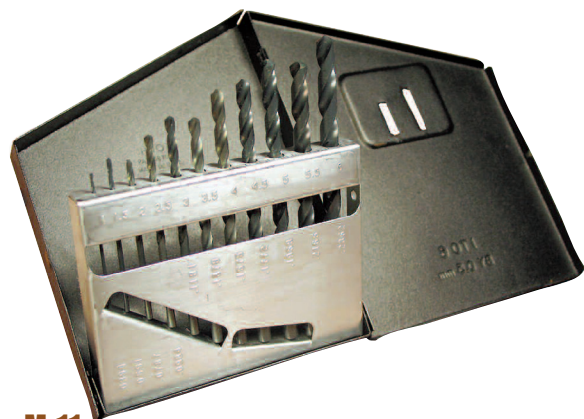

M-11

METRIC

Cutting Tool Sets - Bright / TiN Coated / Black Oxide

Cutting Tool Sets

BRIGHT 1/4" SHANK JOBBER LENGTH - COBALT SCREW MACHINE

Type 120

1/4" Shank - General Purpose 118° Point

- For use in portable air and electric equipment with 1/4" chucks, the shorter-than-jobber length greatly increases rigidity and improves performance.



Q-29

15 Pc.

Part #	Description of Sizes	Qty of each
43580 Q-15	1/16 - 1/2 by 32nds Black Oxide Flutes - 118° Point	1

21 Pc.

Part #	Description of Sizes	Qty of each
43600 Q-21	1/16 - 1/2 by 32nds Black Oxide Flutes - 118° Point	1

29 Pc.

Part #	Description of Sizes	Qty of each
43620 Q-29	1/16 - 1/2 by 64ths Black Oxide Flutes - 118° Point	1

Type 260-D

135° Split point M42-Cobalt

Screw Machine NAS 907C

High-Speed Steel Heavy-Duty Gold Finish

- Use to drill hard, tough metals, free machining stainless steel, titanium alloys and certain abrasive plastics.
- High red hardness of cobalt permits speed 30% over regular high-speed drills.

13 Pc.

Part No.	Description of Sizes	Qty of each
42610 DT-13	1/16 - 1/4 by 64ths M42 Cobalt NAS 907C	1

15 Pc.

Part No.	Description of Sizes	Qty of each
42620 DT-15	1/16 - 1/2 by 32nds M42 Cobalt NAS 907C	1

21 Pc.

Part No.	Description of Sizes	Qty of each
42640 DT-21	1/16 - 3/8 by 64ths M42 Cobalt NAS 907C	1

29 Pc.

Part No.	Description of Sizes	Qty of each
42630 DT-29	1/16 - 1/2 by 64ths M42 Cobalt NAS 907C	1



SPT-26

Type 135-AG

Screw Machine Length, Magnum Super Premium Black & Gold, 135° Split point

- Special Hi-Molybdenum surface treated body and clearance for maximum lubricity.
- Recommended for work hardening grades of stainless steel and other hard metal drilling applications.

26 Pc.

Part No.	Description of Sizes	Qty of each
66850 SPT-26	A - Z	1

29 Pc.

Part No.	Description of Sizes	Qty of each
66490 SPT-29	1/16-1/2 by 64ths	1

60 Pc.

Part No.	Description of Sizes	Qty of each
23560 SPT-60	#1-60	1

Cutting Tool Sets

PARABOLIC TITANIUM NITRIDE & BLACK OXIDE

Type 190-P

Parabolic Flute 135° Split point Black Oxide

- Parabolic flute drills are designed to allow deep hole drilling without frequent drill removal to clear chips.
- Drills perform best in low to medium tensile strength materials.

Type 190-PT

Parabolic Flute 135° Split point - Titanium Nitride

- Exceptional high-performance drill with the Titanium Nitride coating may extend tool life 500% or more in very abrasive drilling applications.
- The parabolic flutes eliminate the need for frequent drill removal in deep hole drilling.

13 Pc.

Part #	1/16-1/4 by 64ths	Qty of each
68080	P-13 Black Oxide -135° Split point	1
68090	PT-13 Titanium Nitride -135° Split point	1

15 Pc.

Part #	1/16-1/2 by 32nds	Qty of each
68100	P-15 Black Oxide -135° Split point	1
68110	PT-15 Titanium Nitride -135° Split point	1

21 Pc.

Part #	1/16-3/8 by 64ths	Qty of each
68120	P-21 Black Oxide -135° Split point	1
68130	PT-21 Titanium Nitride -135° Split point	1

29 Pc.

Part #	1/16-1/2 by 64ths	Qty of each
68150	P-29 Black Oxide -135° Split point	1
68160	PT-29 Titanium Nitride -135° Split point	1



PT-29



P-21

Cutting Tool Sets - Parabolic Titanium Nitride & Black Oxide

Cutting Tool Sets

CAD-HD, SCREW MACHINE & ACRYLIC DRILLS



CAD-15A

Type 191 CAD-HD - Mechanic Length

V-Line Heavy-Duty Black Oxide - 135° Split point

- Black oxide prevents chip welding and increases abrasion resistance.
- American made value line drill

13 Pc.

Part #	1/16 - 1/4 by 64ths	Qty of each
43342 CAD-13A	Black Oxide - 135° Split point	1

15 Pc.

Part #	1/16 - 1/2 by 32nds	Qty of each
43352 CAD-15A	Black Oxide - 135° Split point	1

21 Pc.

Part #	1/16 - 3/8 by 64ths	Qty of each
43362 CAD-21A	Black Oxide - 135° Split point	1

29 Pc.

Part #	1/16 - 1/2 by 64ths	Qty of each
43382 CAD-29A	Black Oxide - 135° Split point	1



AD-7

Type 183-AG

Super Premium Acrylic Drills

- Super **CHIPFREE™** point is precision ground at a 60° angle for gradual penetration to avoid cracking and chipping of the acrylic material.
- Special 0° rake angle on cutting edge eliminates “grabbing” when drill breaks through plastic, acrylic, or laminate surfaces.
- All sizes over 1/4" have 1/4" shanks.

7 Pc.

Part #	1/8, 3/16, 1/4, 5/16, 3/8, 7/16, 1/2	Qty of each
31580 AD-7	Acrylic Drills Super ChipFree™	1

Type 260

118° Point Screw Machine Length High Speed Steel - General Purpose

- The short length of drill and flute makes this an especially rigid drill for greater drilling accuracy.
- This drill is designed for ease of penetration and to facilitate chip removal in tough, hard materials.

29 Pc.

Part #	1/16 - 1/2 by 64ths	Qty of each
10390 SM-29	Screw Machine - 118° Point	1

60 Pc.

Part #	#1 - 60	Qty of each
35210 SM-60	Screw Machine - 118° Point	1

Type 260-BN

118° Point Screw Machine Length Titanium Nitride High Speed Steel

- The short length of drill and flute makes this an especially rigid drill for greater drilling accuracy.
- Can be used for all screw machine operation.
- This drill is designed for ease of penetration and to facilitate chip removal in tough, hard materials

29 Pc.

Part #	1/16 - 1/2 by 64ths	Qty of each
25243 SMN-29	Titanium Nitride - Screw Machine	1

60 Pc.

Part #	#1 - 60	Qty of each
25253 SMN-60	Titanium Nitride - Screw Machine	1

Cutting Tool Sets

BLACK OXIDE & TITANIUM NITRIDE - SCREW MACHINE LENGTH

Type 135 Screw Machine Length, NAS 907C Black Oxide 135° Split point

- A sturdy drill for use in portable power drilling.
- Accurate centering, fast penetration. Ideal for thin metal work.

Type 135-TN Titanium Nitride NAS 907C Screw Machine Length Heavy-Duty 135° Split point

- A sturdy drill for use in portable power drilling.
- Accurate centering, fast penetration. Ideal for thin metal work.
- TiN coating extends tool life.

Type 135-AG Screw Machine Length Black & Gold Super Premium 135° Split point

- Special Hi-Molybdenum surface treated body and clearance for maximum lubricity.
- Recommended for work hardening grades of stainless steel and other hard metal drilling applications.

10 Pc.

1/16 - 5/32 by 64ths + 3/16, 7/32, 1/4

Part #			Qty of each
43660	T-10	Black Oxide - 135° Split point	1

11 Pc.

1/16 - 3/8 by 32nds

Part #			Qty of each
43670	T-11	Black Oxide - 135° Split point	1

13 Pc.

1/16 - 1/4 by 64ths

Part #			Qty of each
43690	T-13	Black Oxide - 135° Split point	1

21 Pc.

1/16 - 3/8 by 64ths

Part #			Qty of each
43710	T-21	Black Oxide - 135° Split point	1

26 Pc.

A - Z

Part No.			Qty of each
66850	SPT-26	Black & Gold - 135° Split point	1

29 Pc.

1/16 - 1/2 by 64ths

Part #			Qty of each
43730	T-29	Black Oxide - 135° Split point	1
96680	TN-29	Titanium Nitride - 135° Split point	1
66490	SPT-29	Black & Gold - 135° Split point	1

60 Pc.

1 - 60

Part #			Qty of each
43750	T-60	Black Oxide - 135° Split point	1
96730	TN-60	Titanium Nitride - 135° Split point	1
23560	SPT-60	Black & Gold - 135° Split point	1



TN-29



TN-60

Cutting Tool Sets - Black Oxide / TiN Coated Screw Machine Length

Cutting Tool Sets



S&D-4CN

S&D-4SP



4 Pc.

Part #	9/16, 5/8, 3/4, 1"	Qty of each
12260 S&D-4	1/2" Shank-Silver & Deming	1
12250 S&D-4SP	1/2" Shank-Silver & Deming	1
74771 S&D-4AGX	1/2" Shank-Silver & Deming	1
29551 S&D-4D	M42 Cobalt	1
30323 S&D-4CN	CN-TECH™ CRYO/NITRIDE 1/2" Shank - Silver & Deming	1

8 Pc.

Part #	9/16 - 1" by 16ths	Qty of each
43200 S&D-8	1/2" Shank - Silver & Deming	1
92400 S&D-8SP	1/2" Shank - Silver & Deming	1
74781 S&D-8AGX	1/2" Shank - Silver & Deming	1
29571 S&D-8D	M42 Cobalt	1
30333 S&D-8CN	CN-TECH™ CRYO/NITRIDE 1/2" Shank - Silver & Deming	1

13 Pc.

Part #	3 ea.(9/16" & 5/8") 2 ea.(3/4") 11/16", 13/16", 7/8", 15/16", 1"	Qty of each
30343 S&D-13CN	CN-TECH™ CRYO/NITRIDE 1/2" Shank - Silver & Deming	1

33 Pc.

Part #	1/2 - 1" by 64ths	Qty of each
43201 S&D-33	1/2" Shank Type 130 Silver & Deming	1
92401 S&D-33SP	1/2" Shank Type 130-AG Silver & Deming	1
30353 S&D-33CN	CN-TECH™ CRYO/NITRIDE 1/2" Shank - Silver & Deming	1

4 Pc. - MRO

Part No.	9/16, 5/8, 3/4 & 1"	Qty of each
54520 S&D-4MRO	1/2" Shank Silver & Deming 130-MRO	1

8 Pc.

Part #	3/16", 1/4", 5/16", 3/8" + 3/8", 1/2", 5/8", 3/4"	Qty of each
82340 VT&R-8P	VORTEX-POINT™ + Fast Spiral Reamer Type 175-VT & 51-UBM	1



1/2" SHANK SILVER & DEMING

Type 130-AG

1/2" Shank Silver & Deming
Premium, 3-Flats on Shank
Heavy-Duty 135° Split point

- 135° Split point for fast penetration and accurate starting without a center punch.
- One piece solid construction
- Sizes larger than 1" diameter have 118° Split point.
- Recommended for use in work hardening grades of stainless steel and other hard metal drilling applications.

Type 130-AGX

1/2" Shank Silver & Deming
Premium - 3-Flats on Shank
118° Split point

- M2 High Speed Steel
- Precision ground point, flutes, body and clearance.
- 118° Split point for general purpose drilling in metal, wood and plastic.



Type 130-CN CN-TECH™ CRYO/NITRIDE

1/2" Shank Silver & Deming
135° Split point - 3-Flats on Shank

- Nitride process case hardening resulting in superior tool life and exceptional corrosion resistance.
- Excellent for truck & trailer repair, and all MRO application.

Type 130-D

1/2" Shank Silver & Deming
M42 Cobalt 135° Split point

- Manufactured from M42 HSS containing 8% cobalt which increases high red hardness.
- Cobalt drills require rigidly held positive feed drilling equipment.

Type 130

1/2" Shank Silver & Deming
118° General Purpose

- This general purpose 118° point high-speed steel drill is recommended for use in portable air and electric drilling equipment with 1/2" chucks.
- Type 130 drills may be used in power applications such as drill presses where a short rigid drill is required.

Type 130-MRO

Silver & Deming, 135° Split point,
3-Flats on Shank

- The 130-MRO is a shorter (5") tougher version of our very popular 1/2" reduced shank product.
- Designed specifically for the needs of the MRO market, the 130-MRO has a split point (135°) to insure fast hole starts without drill walking.
- This feature packed tool provides tremendous value for your drilling dollar.

Type VT&R-8P

VORTEX-POINT™ & FAST SPIRAL REAMER-MAINT.
Mechanics Length, 3-Flat on the Shank

- VORTEX-POINT™ unique tip geometry reduces heat generation & cutting tool wear increasing tool life.
- High speed steel aligning reamer.
- Right hand fast spiral flute, left hand cut.

Cutting Tool Sets

WELDOUT™ SPOTWELD DRILLS SETS

- This rugged high performance drill is designed to effectively cut auto body panel spot welds.
- The high red hardness of cobalt steel permits speeds 30% greater than HSS drills.
- Cobalt steel is substantially more abrasion resistant, resulting in long wearing cutting edges.
- A selection of the most popular sizes of spot weld drills in an attractive, rugged black steel case.



TYPE 187 WO-4

Part #	Description of Sizes
35050	8.0mm & 10mm Single-end 8.0mm & 10mm Twin-end

TYPE 186 WO-6

Part #	Description of Sizes
35010	6.5mm, 8.0mm & 10.0mm single-end drills. 6.5mm, 8.0mm & 10.0mm twin end drills.

LEFT HAND DRILL SETS

Type 190-AL

Magnum Super Premium - Left Hand Spiral 135° Split point

- Precision ground point, flutes, body, clearance and drill diameter for the ultimate in accuracy and performance.
- Ideal for drilling broken studs.
- Need for screw and bolt extractor may be eliminated.

8 Pc.

Part No.	Description of Sizes	Qty of each
87650 LF-8	1/16, 1/8, 3/16, 1/4, 5/16, 3/8, 7/16, 1/2"	1

12 Pc.

Part No.	Description of Sizes	Qty of each
87651 LF-12	1/16 - 5/16 by 32nds, 3/8, 7/16 & 1/2"	1

13 Pc.

Part No.	Description of Sizes	Qty of each
87652 LF-13	1/16 - 1/4 by 64ths	1

15 Pc.

Part No.	Description of Sizes	Qty of each
87654 LF-15	1/16 - 1/2" by 32nds	1

17 Pc.

Part No.	Description of Sizes	Qty of each
87853 LF-17	1/16-1/4 by 64ths, 5/16-1/2 by 16ths	1

29 Pc.

Part No.	Description of Sizes	Qty of each
87854 LF-29	1/16-1/2 by 64ths	1

29 Pc. -Ultra Dex

Part No.	Description of Sizes	Qty of each
87859 LF-29P	1/16-1/2 by 64ths	1

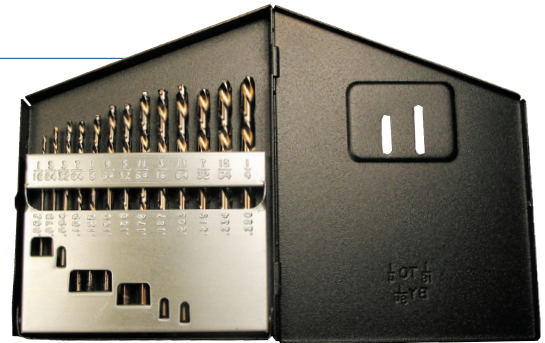

BRAD POINT DRILLS

Type 16-AG

Jobber Length Burrout™ Brad Point Super Premium

- These high performance drills made from Hi-Moly tool steel will cut holes in wood or plastics and leave no burr.
- They will also drill splinter free holes in wood.
- The special BURROUT™ point cuts at the circumference of the hole to avoid the break through burr problems common with standard point drills.



10 Pc.

Part No.	Description of Sizes	Qty of each
42001 BF-10	5/64 - 3/16 by 64ths + 7/32, 1/4"	1

14 Pc.

Part No.	Description of Sizes	Qty of each
42031 BF-14	5/64 - 3/16 by 64ths + 7/32, 1/4 - 1/2" by 16ths	1

Cutting Tool Sets

TAP & DRILL, COMBINATION DRILL & TAPS SETS

Type 40-AG

Combination Drill & Tap Sets - Magnum Super Premium



- Combination drill and taps are ideally suited for on-site tapping in construction, maintenance and repair, assembly, production and other applications where one pass drilling and tapping saves time and costs.
- Gold surface treatment for maximum lubricity.
- Self-centering Split point insures excellent drilling precision and accuracy.



7 Pc.	
Part No.	Description of Sizes
73991	40-AG - DT-7F
Fine	8-36, 10-32, 1/4"-28, 5/16-24, 3/8-24, 7/16-20, 1/2"-20

7 Pc.	
Part No.	Description of Sizes
73990	40-AG - DT-7C
Coarse	8-32, 10-24, 1/4" -20, 5/16-18, 3/8-16, 7/16-14, 1/2"-13

6 Pc.	
Part No.	Description of Sizes
21330	40-AG - DT-6
	6-32, 8/32, 10-24, 10-32, 12-24, 1/4"-20

5 Pc.	
Part No.	Description of Sizes
21324	40-QR - DT-5
	6-32, 8/32, 10-24, 10-32, 12-24, 1/4"-20

TAP & DRILL SETS

Magnum Super Premium

- Hi-Molybdenum super premium twist drill combined with the corresponding Hi-Tungsten Magnum Super Premium tap.
- Both tools are gold surface treated for maximum lubricity, and precision ground for the ultimate in accuracy and performance.

SP-18TD		SPIRAL POINT, NC	
Part No.	Description of Sizes		
57580			
190-AG Drill Sizes	#36, 29, 25, 21, 7, F, 5/16, U & 27/64		
20-AG Tap Sizes	6-32, 8-32, 10-24, 10-32, 1/4-20 7 5/16-18, 3/8-16, 7/16-14 & 1/2-13		

SF-18TDC		STRAIGHT FLUTE, NC	
Part No.	Description of Sizes		
60930			
190-AG Drill Sizes	#36, 29, 25, 21, 7, F, 5/16, U & 27/64		
24-AG Tap Sizes	6-32, 8-32, 10-24, 10-32, 1/4-20, 5/16-18, 3/8-16, 7/16-14 & 1/2-13		

SP-18TDM		SPIRAL POINT, METRIC	
Part No.	Description of Sizes		
57990			
170-AG Drill Sizes (mm)	2.05, 2.50, 2.90, 3.30, 4.20 5.00, 6.70, 8.50 & 10.20		
21-AG Tap Sizes (mm)	2.5-.45, 3.0-.50, 3.5-.60, 4.0-.70, 5.0-.80, 6.0-1.00, 8.0-1.25, 10.0-1.50 & 12.0-1.75		

SF-18TDF		STRAIGHT FLUTE, NF	
Part No.	Description of Sizes		
60940			
190-AG Drill Sizes	#33, 29, 25, 21, 3, 1, Q, 25/64 & 29/64		
24-AG Tap Sizes	6-40, 8-36, 10-24, 10-32, 1/4-28, 5/16-24, 3/8-24, 7/16-20 & 1/2-20		

SP-18TDF		SPIRAL POINT, NF	
Part No.	Description of Sizes		
58010			
190-AG Drill Sizes	#33, 29, 25, 21, 3, 1, Q, 25/64 & 29/64		
20-AG Tap Sizes	6-40, 8-36, 10-24, 10-32, 1/4-28, 5/16-24, 3/8-24, 7/16-20 & 1/2-20		

SF-10TD		STRAIGHT FLUTE, NC	
Part No.	Description of Sizes		
58500			
190-AG Drill Sizes	31/64		
130-AG Drill Sizes	17/32, 21/32, 49/64 & 7/8		
24-AG Tap Sizes	9/16-12, 5/8-11, 3/4-10, 7/8-9 & 1-8		

SP-12TD		SPIRAL POINT, NC	
Part No.	Description of Sizes		
58501			
190-AG Drill Sizes	#36, 29, 25, 21, 7, F		
20-AG Tap Sizes	6-32, 8-32, 10-24, 10-32, 1/4-20 & 5/16-18		

BRIGHT FINISH 118° POINT DRILL & HSS GENERAL PURPOSE TAPS

B-18TD		118° POINT DRILLS MAINT.	
Part No.	Description of Sizes		
60541			
Type 100	Drills Sizes # 7, 21, 25, 29, 36, F, U, 5/16, 27/64		
Type 100	Drill Sizes # 7, 21, 25, 29, 36, F, U		
Type 20	Tap Sizes 6-32, 8-32, 10-24, 10-32, 1/4-20 5/16-18 3/8-16, 7/16-14, 1/2-13		

Cutting Tool Sets

STEP DRILL SETS

Type 78-AG 3-Flatted Shank **Type 78-AGN Titanium Nitride** **Type 78-QR Quick Release**
Type 78-QRN Titanium Nitride **Type 78-ACN Titanium Carbon Nitride**
Ultra Bit™ Multi-Diameter Step Drill 3-Flats on Shank

Type 78-AG Gold Oxide SETS - 3 & 4pc.

01911	1/8 - 1/2, 3/16 - 1/2, & 1/4 - 3/4"
01921	1/8 - 1/2, 3/16 - 1/2, & 3/16 - 7/8"
01931	1/8 - 1/2, 3/16 - 7/8, 7/8 & 1-1/8" ELECTRICIANS - SET
01941	1/8 - 1/2, 3/16 - 1/2, & 1/4" - 1"
01981 4pc.	1/8 - 1/2, 1/4 - 3/4, 1/4 - 7/8, 7/8 - 1-1/8"

Type 78-AGN Titanium Nitride SETS - 3 & 4pc.

01811	1/8 - 1/2, 3/16 - 1/2, & 1/4 - 3/4"
01821	1/8 - 1/2, 3/16 - 1/2, & 3/16 - 7/8"
01831	1/8 - 1/2, 3/16 - 1/2, 7/8 & 1-1/8" ELECTRICIANS - SET
01841	1/8 - 1/2, 3/16 - 1/2, & 1/4" - 1"
01871 4pc.	1/8 - 1/2, 1/4 - 3/4, 1/4 - 7/8, 7/8 - 1-1/8"

Type 78-QR Quick Release SETS - 3 pc.

20761	1/8 - 1/2, 3/16 - 1/2, & 3/16 - 7/8"
20751	1/8 - 1/2, 3/16 - 1/2, & 1/4 - 3/4"
01461	1/8 - 1/2, 3/16 - 1/2, 7/8 & 1-1/8" ELECTRICIANS - SET

Type 78-QRN Titanium Nitride SETS - 3 pc.

68811	1/8 - 1/2, 3/16 - 1/2, & 3/16 - 7/8"
68801	1/8 - 1/2, 3/16 - 1/2, & 1/4 - 3/4"
68581	1/8 - 1/2, 3/16 - 1/2, 7/8 & 1-1/8" ELECTRICIANS - SET

Type 78-ACN Titanium Carbon Nitride SETS - 3 & 4pc.

65431	1/8 - 1/2, 3/16 - 1/2 & 1/4 - 3/4"	(#1, #4, #3)
65411	1/8 - 1/2, 3/16 - 1/2 & 3/16 - 7/8"	(#1, #4, #8)
65421	1/8 - 1/2, 3/16 - 1/2 & 1/4" - 1"	(#1, #4, #2)
65441 4pc.	1/8 - 1/2, 1/4 - 3/4, 1/4 - 7/8, 7/8 - 1-1/8"	(#1, #3, #7, #11)



BOLT EXTRACTOR SETS

Type 420 & Type 421-AG Sets

- Left-hand spiral drills often eliminate the need for bolt extractors.
- Drill may loosen bolt stud with counter clockwise rotation.

Spiral Bolt Extractor Sets

Left Hand Drill

BR-8 Type 420 & 190-AL

Part #	Sizes	Qty of each
88550	EX 1, 2, 3, 4 + 3/32, 1/8, 3/16, 1/4 drills	1

BR-10 Type 420 & 190-AL

Part #	Sizes	Qty of each
58510	EX 1, 2, 3, 4, 5 + 3/32, 1/8, 3/16, 1/4, 5/16 drills	1

Spiral Extractor

Bolt Extractor Set

SE-4N Type 420

Part #	Sizes	Qty of each
47170	EX 2, 3, 4, 5	1

SE-5N Type 420

Part #	Sizes	Qty of each
47180	EX 1, 2, 3, 4, 5	1

Square Extractor Set

Left Hand Drill

BR-8SQ Type 421-AG, Square and 190-AL

Part #	Sizes	Qty of each
70850	E 1, 2, 3, 4 + 1/8, 3/16, 1/4, 5/16	1

Square Extractor

Bolt Extractor Sets

SQE-4 Type 421-AG

Part #	Sizes	Qty of each
70840	E 2, 3, 4, 5	1

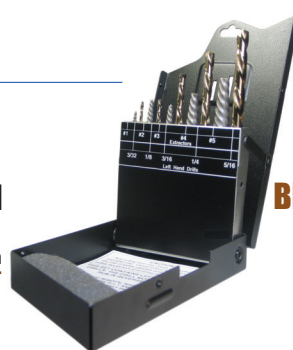

BR-10



CHATTER-PROOF™ COUNTER SINK SETS

Type 82-AG Countersinks
 Type 90-AG Deburring Tools

These high performance, flute-less tools are:

- Single cutting edge - for fast stock removal
- Chatter proof - for a micro smooth finish
- Wide selection of styles & angles - a tool for any job

Recommended for smoother finishes on metal, plastic and wood applications.

TYPE 82-AG & 90-AG SETS

Part No.	Sizes
SP-4CS 10440	82-AG C/S Sizes: CS5S, CS6S, CS5S, CS10S
SP-4ACS 10442	82-AG C/S Sizes: CS6S, CS8S, CS10S, CS3/16S
SP-6DB 10450	90-AG D/B Sizes: DB1/16, DB1/8, DB5/32, DB3/16, DB5/16 & DB9/16
SP-9CS 10443	82-AG C/S Sizes: CS5S, CS6S, CS8S, CS10S, CS1/4, CS5/16, CS3/8, CS7/16, & CS1/2

Cutting Tool Sets

HOLE EXPANSION TOOLS

Type 50-AG

Car Reamers, Standard Flute 3-Flats on Shank



- Special Hi-Tungsten tool steel, gold surface treated body and clearance for maximum lubricity.
- These reamers are designed for the reaming of hardened steel commonly found in truck frames, rail cars, bridges, and pressure vessels.
- Use only to enlarge previously formed or drilled holes.

SET - Contains 1ea.

12270	CR-4SP	3/8", 1/2", 5/8", 3/4"
-------	--------	------------------------

Type 51-AG

Car Reamers - Fast Spiral Hole Buster™
3-Flats on Shank



- Special Hi-Tungsten tool steel, gold surface treated body and clearance for maximum lubricity.
- These reamers are designed for the reaming of hardened steel commonly found in truck frames, rail cars, bridges, and pressure vessels.

SET - Contains 1ea.

12271	CR-4FS	3/8", 1/2", 5/8", 3/4"
12281	SM-4FS	5/16", 3/8", 7/16", 1/2"

The 51-AG, with the fast spiral, is the more aggressive of the two styles. It also will fit the needs of users who prefer a stop collar.

HOLE HOG™ SETS

Type 134-AG

Magnum Super Premium 1/2" Shank
3-flats on Shank, 4 - Flute Core Drill

- A selection of core drills and companion (minimum starting hole size) pilot drills in a black steel index.



SP-8HH Set contains:

Part # 38880

- 1ea: **134-AG** core drill sizes 3/8, 1/2, 5/8 & 3/4"
175-AG drill sizes 1/4, 5/16, 25/64 & 15/32"

SP-6HHL Set contains:

Part # 38870

- 1ea: **134-AG** core drill sizes 1/2, 5/8 & 3/4"
175-AG drill sizes 5/16, 25/64 & 15/32"

SP-6HHS Set contains:

Part # 38860

- 1ea: **134-AG** core drill sizes: 3/8, 1/2 & 5/8"
175-AG drill sizes 1/4, 5/16 & 25/64"

3pc. CARBIDE HOLE CUTTER SET Type CHC-AG

- Ideal for stainless steel, structural steel studs and electrical boxes.
- Can be used on cast iron, brass, aluminum and other thin non-ferrous metals.
- Burr free holes.
- For material up to 3/16"



Size	Steel	Stainless Steel
11/16" to 13/16"	700-1000 RPM	300-700 RPM
7/8" to 1-3/16"	500-800 RPM	200-450 RPM
1-1/4" to 1-9/16"	300-600 RPM	175-315 RPM
1-5/8" to 2"	200-500 RPM	120-225 RPM
2-1/16" to 2-3/8"	200-400 RPM	95-195 RPM
2-7/16" to 3"	150-300 RPM	80-150 RPM

SET - Contains 1ea.

62590	3pc.	7/8", 1-1/8" & 1-3/8"
83990	3pc. Quick Release	7/8", 1-1/8" & 1-3/8"

CARBIDE HOLE CUTTER SETS

Type CHC-AG & CHD-AG

Magnum Premium



Type CHC-AG Cuts up to 3/16" Thin Material

HC-4B Part # 62600

Set contains: 1ea:
Fractional sizes: 11/16", 13/16", 15/16", 1-1/16"

HC-4A Part # 62610

Set contains: 1ea:
Fractional sizes: 5/8", 3/4", 7/8", 1-inch

HC-5C Part # 62620

Set contains: 1ea:
Fractional sizes: 7/8", 1-1/8", 1-3/8", 1-3/4", 2-inch

CHC-AG Individual Sizes Available 9/16" to 5-inch

Type CHD-AG Cuts up to 1" Thick Material

HCD-4B Part # 64300

Set contains: 1ea:
Fractional sizes: 11/16", 13/16", 15/16", 1-1/16"

HCD-4A Part # 64310

Set contains: 1ea:
Fractional sizes: 5/8", 3/4", 7/8", 1-inch

HCD-5C Part # 64320

Set contains: 1ea:
Fractional sizes: 7/8", 1-1/8", 1-3/8", 1-3/4", 2-inch

HCD-5PL Part # 64520

Set contains: 1ea:
Fractional sizes: 5/8", 3/4", 7/8", 1-inch, 1-1/8"

CHD-AG Individual Sizes Available 5/8" to 2-inch

Displays, Cabinets & Indexes

Annular Cutter Sets 134

Counter Displays

Annular Cutter 134

Reamers Type 50-AG & Type 51-AG ... 133

Silver & Deming 133

Stock Master Dispensers & Displays

Type 925 300pc. Fractional 132

Display Packages

Type 175-AG 142

Type CHC-AG 142

Drill Gauges

Type 914 Letter, Fractional & Wire ... 139

Drill Stand

Type 914 Letter, Fractional & Wire. 139

Indexes

Type 902 Indexes Only 143

Type 902 Black Indexes - ID Plate Slot . . 144

Master Drill Dispensers

Type 914 U.S. & Metric Sizes 137

Master Tap Dispensers

Type 914 138

Silver & Deming Drill Dispensers

Type 914 136

Stocking Cases

Type 925

13 pc. Silver & Deming 135

72 pc. Letter 135

91 pc. Metric 135

96 pc. Fractional 135

249 pc. Wire 135

Carbide Hole cutter Display

Type CHC-AG 142

Tap & Die Counter tops

Tap & Round Die 140

Tap & Hex Die 140

Magnum Super Premium

53-SF 140

55-SP 140

Tap & Drill Assortments

Super Premium

67-SP 141

123-SP 141

123-SF 141

Drawer-Mount Dispensers

Type 914

Fractional, Wire, Letter & Empty 140



QUICK INDEX - Displays, Cabinets & Indexes

Displays, Cabinets & Indexes

STOCK MASTER DISPENSERS & DISPLAYS



Type 925

Fractional Drills - 300 Piece Assortment

- Assortment is complete with lexan front display pictured on the left side of this page.
- Case stocks **29 fractional sizes -1/16" thru 1/2" by 64ths** - each size in a separate compartment.
- Individual compartments are plainly marked with drill sizes.
 - Drills will be attractively displayed yet secure with the lexan locking cover.

BLACK Counter Top Display are available stocked with Type 190-AG, 175-AG, 175-VT

BEIGE Counter Top Display are available stocked with Type 150, 190, 115, 100 or 190-GF drills



300 PC. ASSORTMENT EACH. DISPLAY CONTAINS

Part #	Assortment No.	Drill Type
06490	300-SP	190-AG
06520	300-HD	190
54720	300-BR	100
54750	300-BL	115
57640	300-SPM	175-AG
57641	300-RSPM	175/178-AG
68460	300-D	150
40632	300-GF	190-GF
22923	150-VT	175-VT 

240-UB, 250-UB, 240

# of Drills	Fractional Size
24	1/16"
12	5/64"
24	3/32"
18	7/64"
48	1/8"
18	9/64"
18	5/32"
12	11/64"
24	3/16"
6	13/64"
12	7/32"
6	15/64"
24	1/4"
6	17/64"
6	9/32"
2	19/64"
6	5/16"
2	21/64"
3	11/32"
2	23/64"
6	3/8"
2	25/64"
2	13/32"
2	27/64"
3	7/16"
2	29/64"
2	15/32"
2	31/64"
6	1/2"

VORTEX-POINT™ 175-VT

# of Drills	Fractional Size
12	1/16"
6	5/64"
12	3/32"
9	7/64"
20	1/8"
9	9/64"
10	5/32"
6	11/64"
12	3/16"
3	13/64"
6	7/32"
3	15/64"
12	1/4"
3	17/64"
3	9/32"
1	19/64"
3	5/16"
1	21/64"
2	11/32"
1	23/64"
3	3/8"
1	25/64"
2	13/32"
1	27/64"
2	7/16"
1	29/64"
2	15/32"
1	31/64"
3	1/2"

Total 300

Total 150

ACCESSORIES

Part #	Description	Qty. per/pack
58350	Replacement Lock and Key	1

DISPLAY Only Part #45150

Displays, Cabinets & Indexes

SILVER DEMING DISPLAY

Silver & Deming Drills

- Compact Lexan case attractively displays S&D drills.
- Scratch proof Lexan front reduces pilferage and keeps merchandise clean.



SILVER & DEMING COUNTER DISPLAY

Contents	Part #00940	No. of Each
Type 130-AG	9/16, 5/8, 11/16, 3/4, 13/16, 7/8, 15/16, 1"	1

DISPLAY Only Part #00934



CR8SPA

REAMER COUNTER DISPLAY

Type 50-AG -Standard Flute Type 51-AG -Fast Spiral Reamers

- Compact case attractively displays reamers.
- Scratch proof Lexan front reduces pilferage and keeps merchandise clean.

Part #	Type	Contents	#of Each
00941	CR8SPA 50-AG	3/8, 1/2, 9/16, 5/8, 11/16, 3/4, 7/8, 1"	1
00942	CR8FSA 51-AG	3/8, 1/2, 9/16, 5/8, 11/16, 3/4, 7/8, 1"	1

Display Only Part #00934

Display, Cabinets & Indexes - Silver & Deming / Annular Cutters

Displays, Cabinets & Indexes

ANNULAR CUTTERS DISPLAYS

Annular Cutters

- Compact metal case attractively displays annular cutters.
- Scratch proof Lexan front reduces pilferage and keeps merchandise clean.



DISPLAY CONTENT

1 of each, 1/2, 9/16, 5/8, 11/16, 3/4, 13/16, 7/8, 15/16, 1", 1-1/16 by 1" depth and same sizes as above by 2" depth. Both include five pins.



ANNULAR CUTTERS COUNTER DISPLAY

Part #	Size / Type
00943	SB-20 /15C, 15CL
00944	SB-20HS /14, 14L
00949	SB-20SP/13SP, 13LSP

DISPLAY Only Part #00939

SPIRA-BROACH™ ANNULAR CUTTERS

- These unique cutters reduce time and power requirements by cutting larger diameter holes as a ring to produce a solid slug.
- The effort required is a fraction what is needed when using a twist drill or indexable tooling.



SPIRA-BROACH™ Annular Cutters

- Gives the lowest cost per hole
 - Cuts on curved surfaces
 - Leaves a burr-free hole
 - Uses less power
- Allows overlapping cuts on existing holes
 - Stays sharp much longer



SB-5 1" LENGTH

Part #	M	Type	Components
15301	M-42	15	1" Pin, 9/16, 11/16, 13/16, 15/16 & 1-1/16
16901	M-35	14	1" Pin, 9/16, 11/16, 13/16, 15/16 & 1-1/16
16624	M-2	13SP	1" Pin, 9/16, 11/16, 13/16, 15/16 & 1-1/16

SB-5 2" LENGTH

Part #	M	Type	Components
15302	M-42	15L	2" Pin, 9/16, 11/16, 13/16, 15/16 & 1-1/16
16902	M-35	14L	2" Pin, 9/16, 11/16, 13/16, 15/16 & 1-1/16
16629	M-2	13LSP	2" Pin, 9/16, 11/16, 13/16, 15/16 & 1-1/16

Displays, Cabinets & Indexes

STOCKING CASES, FRACTIONAL, WIRE, LETTER, METRIC & SILVER DEMING ASSORTMENT

Type 925

Closed Drawer All-Steel Stocking Units

Stocking cases for Fractional, Wire Gauge, Letter, Metric, and Silver & Deming drills.

FRACTIONAL DRILLS

Part #	Assortment #	Drill Type
06500	96-SP	190-AG
22933	96-VT	175-VT <small>NEW</small>
16010	96-HD	190
37270	96-SPM	175-AG
95130	96-AN	190-AN
81780	96-ALN	190-ALN
54690	96-BR	100
54760	96-BL	115
68440	96-D	150
37271	96-RSPM	175/178-AG

FRACTIONAL DRILLS - 96PC. ASSORTMENT

Drill Size - Contains	Quantity
1/16", 3/32", 1/8", 5/32", 11/64", 3/16", 7/32", 1/4"	6 ea.
5/64", 7/64", 9/64", 13/64", 15/64", 9/32", 5/16", 11/32"	3 ea.
17/64", 21/64", 23/64", 3/8", 25/64", 13/32", 27/64", 7/16", 29/64"	
15/32 & 1/2	2 ea.
19/64, 31/64	1 ea.

WIRE GAUGE

Part #	Assortment No.	Drill Type
16030	249-HD	190
35070	249-SP	190-AG
95140	249-AN	190-AN
54700	249-BR	100
54770	249-BL	115

WIRE GAUGE DRILLS - 249 PC. ASSORTMENT

Drill Size - Contains	Quantity
1-22	3 ea.
23-29	4 ea.
30-60	5 ea.

LETTER DRILLS

Part #	Assortment No.	Drill Type
16020	72-HD	190
35080	72-SP	190-AG
95120	72-AN	190-AN
81212	72-ACN	190-ACN
54710	72-BR	100
54780	72-BL	115

LETTER DRILLS - 72 PC. ASSORTMENT

Drill Size - Contains	Quantity
A-T	3 ea.
U-Z	2 ea.



Fractional & Metric Sizes = 3 Drawers

Wire Sizes = 5 Drawers

Letter Sizes = 3 Drawers

Silver & Deming = 4 Drawers

CABINET ONLY

Fractional Sizes: Part # 44920

Wire Sizes: Part # 44930

Letter Sizes: Part # 44940

Metric Sizes: Part # 08930

Silver & Deming: Part # 43203

METRIC DRILLS

Part #	Assortment No.	Drill Type
18910	91-SP	170-AG

METRIC DRILLS - 91 PC. ASSORTMENT

Drill Size - Contains	Quantity
2.5, 3.5, 4.5, 5.0, 5.5, 6.0 & 6.5	5 ea.
1.5, 2.0, 3.0, 7.0, 8.0 & 8.5	4 ea.
1.0, 4.0, 9.0, 9.5, 10.0, 10.5, 11.0 & 12.0	3 ea.
7.5, 11.5, 12.5 & 13.0	2 ea.

SILVER & DEMING

Part #	Assortment No.	Drill Type
43202	S&D 13	130
92402	S&D 13-SP	130-AG

SILVER & DEMING - 13PC. ASSORTMENT

Drill Size - Contains	Quantity
9/16, 5/8	3 ea.
3/4	2 ea.
11/16, 13/16, 7/8, 15/16, 1"	1 ea.

Displays, Cabinets & Indexes

SILVER & DEMING DRILL DISPENSERS

Type 914



HUOT MODEL 13166

Part #	Dimensions Inches	Weight	Qty. per/pack
00950	14-5/8" W x 7-3/8" D x 7-3/4" H	13-1/4 lbs.	1

Holds: 2 each Reduced Shank S & D bits from 33/64ths to 63/64ths by 64ths.

HUOT MODEL 13167

Part #	Dimensions Inches	Weight	Qty. per/pack
00951	14-5/8" W x 7-3/8" D x 7-3/4" H	10-3/4 lbs.	1

Holds: 2 each Reduced Shank S & D bits from 1, 1-1/32, 1-1/16, 1-1/8, 1-5/32, 1-3/16, 1-1/4, 1-5/16, 1-3/8, 1-7/16 & 1-1/2.

DRAWER-MOUNT DRILL ORGANIZER

Type 914

Drawer-Mount

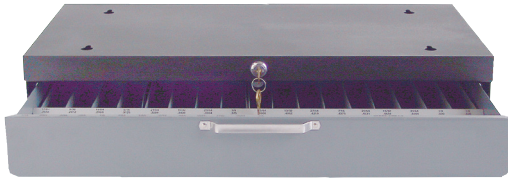

The latest thing in organizing, sorting, storing, and securing your cutting tools. The outer shell can be mounted underneath a work bench, desk, shelf, inside a cabinet, or just about anywhere. The drawer has a cam-lock to keep your cutting tools safely locked away.

- Workbench-space-saver.
- Out-of-the way convenience.
- Security-built in cam lock and two keys.
- Heavy-duty ball bearing drawer slides.
- Time-saving cutting tools are stored away in their proper locations making it fast and easy to find the right tool.
- Each space clearly marked for the proper tool.
- Decimal equivalent shown under each size tool.

Overall Dimensions: 26 -1/8" W x 12-1/2" D x 4-1/2" H

Drawer Dimensions: 23 -1/8" W x 11" D x 3" H

Shipping Weight: 14 -1/2 pounds

PART NO. 01021

Huot Model 30000
For Fractional Drills 1/16" to 1/2" x 64ths

PART NO. 01023

Huot Model 30050
For Letter Drills from A to Z

PART NO. 01022

Huot Model 30025
For Wire Gauge Drills #1 to #60

PART NO. 01024

Huot Model 30001
Empty drawer-mount drawer, no dividers
for miscellaneous storage space.

Displays, Cabinets & Indexes

MASTER DRILL DISPENSERS

Baked, Epoxy finish for long life

Lockable models

Heavy gauge fabricated steel cabinet and drawers

Stackable models, full drawer extension slides

Exclusive, patented Glydex® slides on Master Series

Easy-to-read, permanent, durable identification strips show tool size and decimal equivalents!

- Cost effective tool management and storage
- Safest way to store sharp tools
- Fast inventory tracking
- Eliminates wasted searching
- Helps prevent losing or damaging tools
- See tool inventory at a glance
- 100% U.S.A. made!

Type 914

Master Drill Dispensers (U.S. and Metric Sizes)

Feature:

- All steel cabinet with vinyl dividers to help protect and separate bits.
- Each cabinet is lockable with its own set of 2 keys.
- Each drawer measures 23-1/8" wide; 11" front to back.
- Stackable for larger inventories at one location.
- Lower drawer is undivided for extra long drills, reamers, and miscellaneous tools.
- Drawer Divider Kit available for lower drawer.

U.S. Sizes

Part # 00682

Holds full packages (minimum of 12 pc.) of jobber or screw machine length drills, fractional, letter, and wire gauge sizes in one complete cabinet.

- Top drawer holds fractional drills 1/16" to 1/2" by 64th with 42 compartments.
- 2nd drawer is for #1 to #60 wire gauge with 75 compartments.
- 3rd drawer for letter size A to Z with 42 compartments.

HUOT MODEL 13175 - U.S. SIZE DRILLS

Part #	Dimensions Inches	Weight	Qty. per/pack
00682	26" W x 12" D x 12 - 1/2" H	43 lbs.	1

Metric Sizes

Part # 00681

Holds metric drills from .35mm to 13.00mm.

- Sizes include: .35mm to 2.50mm by .05mm, 2.6mm to 10.0mm by .1mm, 10.2mm, 10.5mm, 10.8mm, 11.0mm, 11.2mm, 11.5mm, 11.8mm, 12.0mm, 12.2mm, 12.5mm, and 13.0mm.

138 compartments to store and inventory all your Metric drill bits. Same great features as our #00682 Jobber length Master cabinet.

HUOT MODEL 13180 - METRIC SIZE DRILLS

Part #	Dimensions Inches	Weight	Qty. per/pack
00681	26" W x 12" D x 12 - 1/2" H	43 lbs.	1

Displays, Cabinets & Indexes

MASTER TAPS DISPENSERS

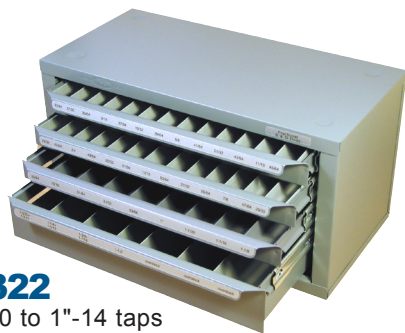

Part # 01322

For sizes 1/4"-20 to 1"-14 taps
Many compartments hold multiples of a given size tap.

Holds - Bottom, Plug and Taper of each size:

1/4-20	1/4-28	5/16-18	5/16-24	3/8-16	3/8-24
7/16-14	7/16-20	1/2-13	1/2-20	9/16-12	9/16-18
5/8-11	5/8-18	3/4-10	3/4-16	7/8-9	7/8-14
1"-8	1"-14				

Holds - Taper, Plug, Bottoming & Spiral:

2-56	3-48	3-56	4-40	4-48	5-40
5-44	6-32	6-40	8-32	8-36	10-24
10-32	12-24	12-28			

Type 914

- **Holds** most common NC/NF sizes from 1/4" to 1-1/2"
- **Holds** metrics from 2.5 mm to 30 mm
- **Holds** machine screw size 2-56 thru 12-28, **Taper, Plug, Bottoming, and Spiral**
- Extruded vinyl drawer dividers protect taps
- **Top drawer** has 40 compartments
- **Second drawer** has 78 compartments
- **Third drawer** has 21 compartments
- **Fourth drawer** has 13 compartments
- Stackable for larger inventories
- Lockable

Part # 01321

HUOT MODEL 13585

Part #	Dimensions Inches	Weight	Qty. per/pack
01321	26" W x 12" D x 12 - 1/2" H	46 lbs.	1

HUOT MODEL 13580

Part #	Dimensions Inches	Weight	Qty. per/pack
01322	26" W x 12" D x 12 - 1/2" H	46 lbs.	1

MASTER TAPS DISPENSERS

Type 914

- **Holds all sizes** of National Pipe taps (NPT) from 1/16" to 2"
- **Top drawer** has **13 compartments** measuring 3/4" W x 7/8" H x 4-1/2" D
- **2 compartments** for 1/16-27, 2 for 1/8-27, 3 for 1/4-18, 3 for 3/8-18 and 3 for 1/2-14
- **Middle drawer** has **9 compartments** for 3 for 3/4-14, 3 for 1-11-1/2, 3 for 1-1/4-11-1/2
- **Bottom drawer** has **7 compartments** measuring 1-3/4" W x 2" H x 7" D
- **3 compartments** for 1-1/2-11-1/2
- **1 large compartment** for 2-11-1/2

Part # 01323

HUOT MODEL 13560

Part #	Description	Qty. per/pack
01323	National Pipe Taps (NPT)	1

HUOT MODEL 13595

Part #	Description	Qty. per/pack
01324	Taps, Drill & Dies	1



Part # 01324

METRIC - Taps, Drills & Dies

From 2.50 x 0.45 Tap to 12.0 x 1.75 Tap and holds the following sizes:

- **Top drawer holds**
 - 2.50 x 0.45 Tap - 2.05 Drill, Dies
 - 3.00 x 0.50 Tap - 2.50 Drill, Dies
 - 3.50 x 0.60 Tap - 2.90 Drill, Dies
 - 4.00 x 0.70 Tap - 3.30 Drill, Dies
- **Middle drawer holds**
 - 5.00 x 0.80 Tap - 4.20 Drill, Dies
 - 6.00 x 1.00 Tap - 5.00 Drill, Dies
 - 8.00 x 1.25 Tap - 6.70 Drill, Dies
- **Bottom drawer holds**
 - 10.00 x 1.50 Tap - 8.50 Drill, Dies
 - 12.00 x 1.75 Tap - 10.20 Drill, Dies
- **Room in top drawer** for your T-handle wrench

Displays, Cabinets & Indexes

DRILL STANDS

Type 914

- These drill stands can be hung on a wall, used on a bench, or mounted on a press.
- Durably made from a single piece of prime steel, rigidly formed.

Part # 01011

Letter sizes A to Z inclusive

Part # 01012

Fractional drills 1/16" to 1/2" by 64ths inclusive

Part # 57430

Silver & Deming drills from 1/2"-1" by 64ths. Held by shank



HUOT MODEL 11850 PART #01011		
Part #	Dimensions Inches	Qty. per/pack
01011	5-5/8" W x 2-5/8" D x 1-1/2" H	1

HUOT MODEL 11985 PART #57430		
Part #	Dimensions Inches	Qty. per/pack
57430	13" W x 5" D x 2" H	1

HUOT MODEL 11900 PART #01012		
Part #	Dimensions Inches	Qty. per/pack
01012	5-5/8" W x 2-5/8" D x 1-1/2" H	1

DRILL GAUGES

Type 914

Economical gauge made from prime steel and finished.

Part # 58520

For measuring 1/16" to 1/2" by 64ths drill bits.

Part # 58522

For measuring #1 to 60 wire gauge drill bits.

Part # 58521

For measuring drills 1/2" to 1" by 64ths.

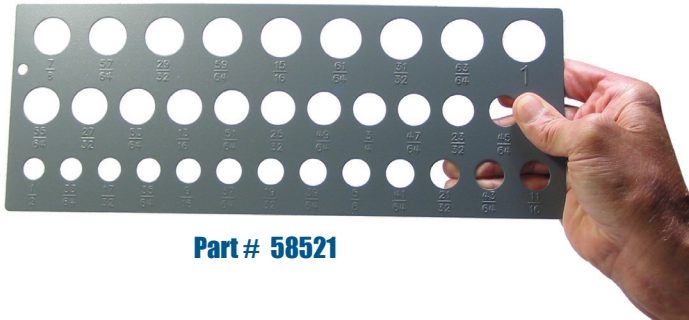

Part # 58521

HUOT MODEL 12250 PART #58520		
Part No.	Dimensions Inches	Qty. per/pack
58520	6" W x 3" D	1

HUOT MODEL 12280 PART #58521		
Part No.	Dimensions Inches	Qty. per/pack
58521	13" W x 5" D	1

HUOT MODEL 12260 PART #58522		
Part No.	Dimensions Inches	Qty. per/pack
58522	5-1/4" W x 2" D	1

Displays, Cabinets & Indexes

STOCKED COUNTER DISPLAYS

- Compact metal case attractively displays complete assortment of Taps, Dies, and Wrenches.
- Locking scratch proof Lexan front reduces pilferage and keeps merchandise clean.
- Broad range of sizes. Practically all customers can be served with small investment.
- Price strips furnished on each display for quick reference at point of sale
- Furnished with Hex or Round Dies

Part # 50010 - Display with Round Dies

Part # 50210 - Display with Hex Dies



**DISPLAY ONLY
#45000**

DISPLAY CONTENTS

Contents	Size	No. of Each
Plug Tap	1/4-20 NC	6
	1/4-28 NF	6
	5/16-18 NC	6
	5/16-24 NF	6
	3/8-16 NC	6
	3/8-24 NF	6
	7/16-14 NC	6
	7/16-20 NF	6
	1/2-13 NC	6
	1/2-20 NF	6
	9/16-12 NC	6
	9/16-18 NF	6
	5/8-11 NC	6
	5/8-18 NF	6
	3/4-10 NC	6
	3/4-16 NF	6
	4-40 NC	12
	6-32 NC	12
8-32 NC	12	
10-24 NC	12	
10-32 NF	12	
12-24 NC	12	
Pipe Tap	1/8-27NPT	6
Round or Hex Die	1/4-20 NC	3
	1/4-28 NF	3
	5/16-18 NC	3
	5/16-24 NF	3
	3/8-16 NC	3
	3/8-24 NF	3
	7/16-14 NC	3
	7/16-20 NF	3
	1/2-13 NC	3
	1/2-20 NF	3
	9/16-12 NC	3
	9/16-18 NF	3
	5/8-11 NC	3
	5/8-18 NF	3
	3/4-10 NC	3
	3/4-16 NF	3
	4-40 NC	3
	6-32 NC	3
	8-32 NC	3
	10-24 NC	3
	10-32 NF	3
12-24 NC	3	
1/8-27 NPT	3	
T-Handle Tap Wrench	0 to 1/4"	3
T-Handle Tap Wrench	3/16" to 1/2"	3
Economy Die Stock	1" Round Hex	3

When Ordering Specify Round or Hex Dies

TAP & DIE COUNTER-TOP

Magnum Super Premium

**Tap & Die Counter Top Dispenser 53pc.
Straight Flute Taps & Hex Dies**

53-SF Assortment contains:

Type 24-AG Straight flute plug tap sizes:

3 each 6-32, 8-32, 10-24, 10-32 & 1/4-20;

2 each 5/16-18, 3/8-16, 7/16-14 & 1/2-13;

1 each 4-40, 12-24, 1/4-28, 5/16-24, 3/8-24, 7/16-20,
1/2-20, 9/16-12, 5/8-11 & 3/4-10.

Hex die sizes:

1 each 4-40, 6-32, 8-32, 10-24, 10-32, 12-24, 1/4-28,
5/16-18, 5/16-24, 3/8-16, 3/8-24, 7/16-14, 7/16-20,
1/2-13, 1/2-20, 9/16-12, 5/8-11 & 3/4-10;

2 each 1/4-20.

Includes glass front stocking cabinet

PART # 35150

Magnum Super Premium

**Tap & Die Counter Top Dispenser 55pc.
Spiral Point Taps & Hex Dies**

55-SP Assortment contains:

Type 20-AG Spiral point tap sizes:

3 each 6-32, 8-32, 10-24, 10-32 & 1/4-20;

2 each 5/16-18, 3/8-16, 7/16-14 & 1/2-13;

1 each 4-40, 12-24, 1/4-28, 5/16-24, 3/8-24, 7/16-20,
1/2-20, 5/8-11, 5/8-18, 3/4-10 & 3/4-16

Hex die sizes:

1 each 4-40, 6-32, 8-32, 10-24, 10-32, 12-24, 1/4-28,
5/16-18, 5/16-24, 3/8-16, 3/8-24, 7/16-14, 7/16-20,
1/2-13, 1/2-20, 5/8-11, 5/8-18, 3/4-10 & 3/4-16

2 each 1/4-20

Includes glass front stocking cabinet.

PART # 35160

Displays, Cabinets & Indexes

TAP & DRILL ASSORTMENTS

Magnum Super Premium

- Special Hi-Tungsten & Hi-Molybdenum tool steels, Gold surface treated for maximum lubricity.
- Recommended for use in production Tapping and Drilling of work hardening grades of stainless steel and other hard metal applications.
- Precision ground tap threads for the ultimate in accuracy and performance.



CABINET ONLY PART #35100

Magnum Super Premium

Tap & Drill Dispenser Assortment

67pc. Spiral Point Taps & Jobber Length Drills

67-SP Assortment contains:

Type 190-AG - Jobber drill sizes:

- 6 each** #36, 29, 25, 21
- 3 each** #7, F & 5/16
- 2 each** #3, I, Q, U, 25/64, 27/64 & 29/64

Type 20-AG - Spiral point Plug tap sizes:

- 3 each** 1/4-20
- 2 each** 6-32, 8-32, 10-24, 10-32 and 1 each 1/4-28, 5/16-18, 5/16-24, 3/8-16, 3/8-24, 7/16-14, 7/16-20, 1/2-13 & 1/2-20

Includes 3 drawer stocking cabinet.

PART # 35121

Magnum Super Premium

Tap & Drill Dispenser Assortment

123pc. Spiral Point Taps & Jobber Length Drills

123-SP Assortment contains:

Type 190-AG - Jobber drill sizes:

- 12 each** #36, 29, 25, 21
- 6 each** #7, F & 5/16
- 3 each** #3, I, Q, U, 25/64, 27/64 & 29/64

Type 20-AG - Spiral point plug tap sizes:

- 6 each** 1/4-20
- 3 each** 6-32, 8-32, 10-24, 10-32, 5/16-18 & 3/8-16
- 2 each** 1/4-28, 5/16-24, 3/8-24, 7/16-14 & 1/2-13
- 1 each** 7/16-20 & 1/2-20

Includes 3 drawer stocking cabinet

PART # 35120

Magnum Super Premium

Tap & Drill Dispenser Assortment

123pc. Straight Flute Taps & Jobber Length Drills

123-SF Assortment contains:

Type 190-AG - Jobber drill sizes:

- 12 each** #36, 29, 25, 21
- 6 each** #7, F & 5/16
- 3 each** #3, I, Q, U, 25/64, 27/64 & 29/64

Type 24-AG - Straight flute plug tap sizes:

- 6 each** 1/4-20
- 3 each** 6-32, 8-32, 10-24, 10-32, 5/16-18 & 3/8-16
- 2 each** 1/4-28, 5/16-24, 3/8-24, 7/16-14 & 1/2-13
- 1 each** 7/16-20 & 1/2-20

Includes 3 drawer stocking cabinet

PART # 35110

DISPLAY PACKAGES

Type 175-AG

Mechanic Length Drills Magnum Super Premium - Black & Gold - 135° Split Point

- Super Premium drills in attractive, displays.
- All drills are packed on cards with logo and scanable bar code.
- 178-AG drills with flattened reduced shanks are used where indicated.



All displays contain an attractive header card and 1/4" peg board fasteners.

DISPLAY NO. DC145SP

Part # 81651

Contents	Size	No. of Cards
175-AG	3/16, 1/4	5
1/16 thru 1/2	1/16, 5/64, 3/32, 7/64, 1/8, 5/16	4
	9/64, 5/32, 11/64, 13/64, 7/32 15/64, 3/8	3
	17/64, 9/32, 19/64, 21/64, 11/32	2
	23/64, 7/16, 1/2	
	25/64, 13/32, 27/64, 29/64 15/32, 31/64	1

* 1/16" thru 1/8" = 3 per card, 9/64" thru 1/4" = 2 per card

DISPLAY NO. DC116SP

Part # 81631

Contents	Size	No. of Cards
175-AG 1/16 thru 13/32	1/8"	7
	1/16, 3/32"	5
	5/32"	3
178-AG 7/16 thru 1/2	1/4"	7
	3/16, 5/16"	6
	9/32, 11/32, 3/8"	4
	13/32, 7/32, 7/16"	3
	1/2"	2
	15/32"	1

DISPLAY NO. DC72SP

Part # 81641

Contents	Size	No. of Cards
175-AG 1/16 thru 3/8	1/8	7
	1/16, 3/32	5
	5/32	3
178-AG 7/16 thru 1/2	1/4	7
	3/16, 5/16	6
	3/8	4
	7/32, 7/16	3
	1/2	2

* 1/16" thru 1/8" = 3 per card, 9/64" thru 1/4" = 2 per card

Type CHC-AG

Magnum Super Premium Carbide Tipped Holecutter Display

- Carbide tipped hole cutters are made with ultra-hard tungsten carbide teeth for cutting through tough alloys.
- The design provides sharp, crisp cuts without burrs and prevents over penetration.
- The built-in pilot drill with ejector spring quickly discharges the slug effortlessly.

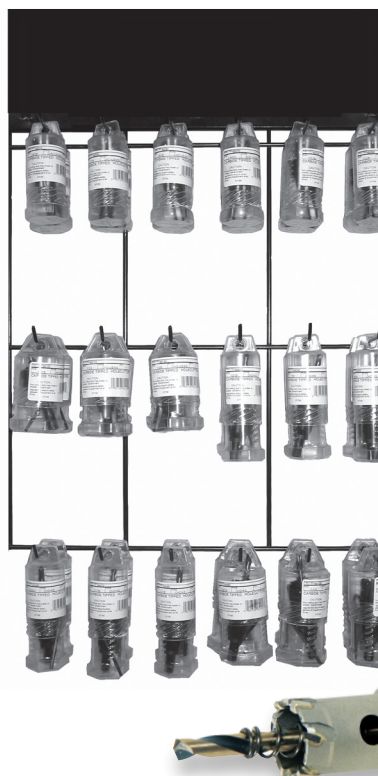

Display
Rack Only

Part # 14120

CARBIDE HOLE CUTTERS DISPLAY

Part # 62700

Contents	Size	No. of Each
CHC-AG	13/16, 7/8, 15/16, 1"	1
Depth of cut	1-1/16, 1-1/8, 1-3/16, 1-1/4, 1-3/8	
3/16"		
CHD-AG	13/16, 7/8, 15/16, 1",	1
Depth of cut	1-1/16, 1-1/8, 1-3/16, 1-1/4, 1-3/8	
1"		
Display Rack	16" width x 27" height	1
(Display Rack Only Part #14120)		

Displays, Cabinets & Indexes

INDEXES ONLY
Type 902

Jobber Indexes

Part #	Description	Qty. per/pack
43870	I-11	1
43760	I-13	1
49044	I-13M	1
43770	I-15	1
43780	I-20	1
43790	I-21	1
43880	I-25	1
43800	I-26	1
43810	I-29	1
49049	I-41	1
43860	I-60	1
43940	I-115	1
43850	H-13	1



Silver & Deming Indexes

Part #	Description	Qty. per/pack
43930	I-SD	1
12240	PL-4SD	1
12243	PL-8SD	1
57430	A-33	1

Plastic Indexes & Cases

Part #	Description	Qty. per/pack
44000	13-PL	1
44020	I-25TDI	1
44040	I-40TDI	1
61670	I-58TDI	1

Screw Machine Indexes

Part #	Description	Qty. per/pack
43890	S-13	1
43900	S-21	1
43910	S-29	1
43920	S-60	1

Black & Gold

Indexes - Indexes Only

Displays, Cabinets & Indexes

BLACK INDEXES - ID PLATE SLOT

Type 902



Display, Cabinets & Indexes - Black Indexes / ID Plate Slot

Jobber Indexes

Part #	Description	Qty. per/pack
28580	I-3SP	1
57460	I-13SP	1
57470	I-15SP	1
57480	I-21SP	1
57490	I-26SP	1
57500	I-29SP	1
57510	I-60SP	1
57520	I-115SP	1
58930	I-25SP	1
99860	I-21SPR	1

Screw Machine Index

Part #	Description	Qty. per/pack
23250	I-29SPT	1

Silver & Deming Indexes

Part #	Description	Qty. per/pack
57440	ISD-8SP	1

Hole Hog™ Index

Part #	Description	Qty. per/pack
38850	I-8HH	1

Tap & Drill Indexes

Part #	Description	Qty. per/pack
58320	I-10TD	1
57570	I-18TD	1
57980	I-18TDM	1
58000	I-18TDF	1
58502	I-12TD	1

Drill & Extractor Index

Part #	Description	Qty. per/pack
58331	I-BRSQ	1

Tap Indexes

Part #	Description	Qty. per/pack
61630	I-19T	1
61640	I-10T	1

Spotweld™ Indexes

Part #	Description	Qty. per/pack
35000	I-6WO	1
16040	I-4WO	1